

CATALOG P



**GENERAL
RADIO
COMPANY**

WEST CONCORD · MASSACHUSETTS · USA

Since 1915

Manufacturers of Electronic Apparatus for Science and Industry



File Courtesy of GRWiki.org

GENERAL RADIO COMPANY

Main Office and Factory

WEST CONCORD, MASSACHUSETTS

Telephone: (Concord) EMerson 9-4400

(Boston) CLearwater 9-8900

Cable Address: GENRADCO, BOSTON

DISTRICT OFFICES

General Radio sales engineering offices are maintained in the following cities. These offices are staffed by competent factory-trained engineers. We invite your inquiries for technical, commercial, and service information.

Office	Telephone	Staff
NEW YORK Broad Avenue at Linden, Ridgefield, N. J.	(N. Y.) WOrth 4-2722 (N. J.) WHitney 3-3140	George G. Ross, <i>Manager</i> Leo J. Chamberlain Peter Bishop Edward F. Sutherland
PHILADELPHIA 1150 York Road, Abington, Pa.	HANcock 4-7419	Kipling Adams, <i>Manager</i> John E. Snook
WASHINGTON AND BALTIMORE 8055 13th Street, Silver Spring, Md.	JUNiper 5-1088	C. William Harrison, <i>Manager</i> John C. Held Frank J. Finnegan
CHICAGO 6605 West North Avenue, Oak Park, Ill.	Village 8-9400	William M. Ihde, <i>Manager</i> Robert E. Bard L. C. (Tom) Fricke Robert P. Delzell
SAN FRANCISCO 1186 Los Altos Avenue, Los Altos, Calif.	WHitecliff 8-8233	James G. Hussey, <i>Manager</i> Donald M. Vogelaar
LOS ANGELES 1000 North Seward Street, Los Angeles 38, Calif.	HOLlywood 9-6201	William R. Saylor, <i>Manager</i> Alan O. Abel Frank J. Thoma Kenneth J. Castle
CANADA 99 Floral Parkway, Toronto 15, Ontario	CHerry 4-6221	Arthur Kingsnorth, <i>Manager</i> Richard J. Provan

REPAIR SERVICES

East Coast
General Radio Company
Service Department
West Concord, Mass.
Telephone: (Concord) EMerson 9-4400
(Boston) CLearwater 9-8900

New York
General Radio Company
Service Department
Broad Ave. at Linden
Ridgefield, N. J.
Telephone: (N. Y.) WOrth 4-2722
(N. J.) WHitney 3-3140

Midwest
General Radio Company
Service Department
6605 West North Avenue
Oak Park, Illinois
Telephone: Village 8-9400

West Coast
Western Instrument Co.
826 North Victory Boulevard, Burbank, California
Telephone: VICTORIA 9-3013

Canada
Bayly Engineering, Ltd.
First Street, Ajax, Ontario
Telephone: EMPIRE 8-6866

EXPORT REPRESENTATIVES

For a list of representatives in other countries see inside back cover



QUICK INDEX

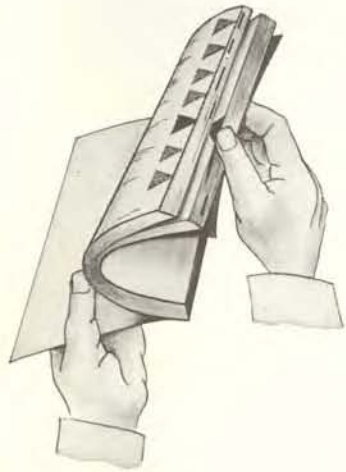

The QUICK INDEX listed here and on the back cover is for your convenience in finding sections of this catalog quickly.

Bend the catalog as shown in the sketch above. The arrows point to the red tabs on the first page of each section. Run your thumb across the edge of the pages to the tab for the section you want, and open the catalog to the general introduction which starts each section.

A complete INDEX BY TITLE and an INDEX BY TYPE NUMBER will be found at the end of the catalog.

HOW TO ORDER	TERMS ETC.	ix
AMPLIFIERS — SEE DETECTORS		
BRIDGES	AND OTHER IMPEDANCE-MEASURING INSTRUMENTS	1
CAPACITORS — SEE REACTANCE		
COAXIAL	ELEMENTS, SLOTTED LINES, CONNECTORS, ADAPTORS	41
DETECTORS AND AMPLIFIERS		
DISTORTION METERS — SEE WAVE ANALYZERS		
FREQUENCY	STANDARDS AND METERS	69
GENERATORS	STANDARD-SIGNAL	89
	OSCILLATORS	99
	PULSE AND NOISE	117
INDUCTORS — SEE REACTANCE		
METERS	VTVM, POWER, MEGOHM, ELECTROMETER	127
MONITORS	MODULATION AND FREQUENCY FOR RADIO AND TV STATIONS	135
POWER SUPPLIES		
RECORDERS AND DIAL DRIVES		
RESISTANCE	DECADES, ATTENUATORS, VOLTAGE DIVIDERS	153
REACTANCE	CAPACITORS, INDUCTORS, STANDARDS, DECADES	163
SOUND AND VIBRATION METERS AND ANALYZERS		
STROBOSCOPES		
SWEEP DRIVES — SEE RECORDERS		
UNIT INSTRUMENTS		
UHF-VHF INSTRUMENTS — SEE COAXIAL		
VARIAC®	ADJUSTABLE AUTOTRANSFORMERS	203
	AUTOMATIC VOLTAGE REGULATORS	217
	MOTOR SPEED CONTROLS	219
WAVE ANALYZERS		
PARTS AND ACCESSORIES		
CHARTS AND TABLES		
INDEX	BY TITLE — BY TYPE NUMBER	249



View of new enlarged General Radio plant in West Concord, Massachusetts.

We Sell Direct . . .

To develop the type of product manufactured by the General Radio Company requires a large staff of engineers, each a specialist in one or more branches of electronic engineering and science.

There has always been close contact between our Company and our customers, many of whom are themselves engineers and scientists. To maintain and to further this contact is the responsibility of our staff of field engineers. This group has the principal function of working directly with the customer for the best selection of instruments for the job with the minimum expenditure. The advice of our development engineering staff is available for expert consultation when the need arises.

Because of the technical nature and diverse uses of our equipment we feel that a direct method of distribution is the most efficient and useful to the buyer. Consequently, the General Radio Company sells its products directly to the user in the United States and Canada, with no intermediary distributing organization, on a net, no discount basis. The buyer is thus assured of receiving the lowest possible price less all resale discounts and commissions and one that he can immediately find by consulting a current price list. We have always felt that price is as much a part of specifications as is a technical description.

In major marketing areas of the United States and in Toronto the Company maintains district sales offices, which are staffed by skilled factory-trained engineers who are in a position to speak directly for the factory, and who are conveniently available for consultation on all technical and commercial questions. The locations of these offices are given in the inside front cover.

In order that customers outside the United States may receive equivalent technical service, exclusive representatives have been appointed in most countries abroad, each capable of giving technical and commercial information regarding General Radio products. For a list of export representatives, see the inside back cover of this catalog. In all matters regarding General Radio apparatus, the customer should communicate with the appropriate representative. Prices listed in the catalog are for domestic use only. Costs in countries abroad, where import duty, freight, and taxes must be added, may be obtained from the representatives in those countries.

CATALOG



P

APRIL 1959

The Best Instruments in Electronics

GENERAL RADIO COMPANY

WEST CONCORD, MASSACHUSETTS

Copyright, 1959, by General Radio Company, W. Concord, Mass., U.S.A.



File Courtesy of GRWiki.org

THE HALLMARK OF QUALITY



Quality is traditional in products that bear the  label. General Radio instruments are quality instruments, built from quality components to give reliable service and to maintain accuracy over a long and useful life.

Some of this Company's earliest products were laboratory standards, and General Radio today still supplies the standards of inductance, capacitance, and frequency that are basic to the electronics industry. The successful manufacture of standards is predicated on quality, both in design and in production. This tradition of quality is evidenced throughout the GR line. GR instruments are designed and built to exacting specifications, to be accurate, rugged, and reliable. Many a laboratory has GR products built several decades ago which are still giving accurate and reliable service.

Performance specifications are an important yardstick for quality. General Radio specifications are conservative and honest. Each instrument is calibrated to tolerances at least 25% tighter than those published. Performance to these specifications is guaranteed for 2 years. General Radio is the first, and thus far the

only, instrument manufacturer to make this guarantee.

Although published and guaranteed specifications attest the accuracy, range and versatility of GR products and indicate the ingenuity and care which go into their design and development, they cannot disclose all the attention to detail in design and construction which makes for customer satisfaction and long and useful service.

DESIGN

General Radio's aim is to pioneer, not to copy. New circuits, new components, new designs, new techniques—these form the basis of new General Radio instruments. General Radio development engineers bring to instrument design a wide variety of background and experience in the United States and abroad. Many of them are internationally recognized authorities in their particular fields. The advice of this engineering staff is available to General Radio customers in the solution of their measurement problems.

MANUFACTURE

General Radio quality is also evident in details of construction. Tangible evidence of these quality details is readily seen in a typical instrument. The panel and cabinet are of exceptionally heavy gauge aluminum alloy (usually $\frac{1}{8}$ to $\frac{1}{4}$ in.) so that they will not hum, dent, buckle, rattle or rust. Relay-rack cabinets readily adapt from drawer-slide rack mounting to neat looking bench units by the addition of end frames which provide feet and handles. Dials have low-reflective backgrounds with markings carefully proportioned for easy reading and have concentric lathe-turned edges. The rugged phenolic knobs with reamed brass inserts are a widely copied design of General Radio origin. Binding posts, coaxial connectors, handles, panel screws and other items are of proprietary GR design and were created to provide instrument components of instrument grade rather than ordinary commercial grade.

Inside the instrument are precision components, air capacitors, potentiometers, and transformers, developed and manufactured at General Radio specifically for instrument use. The special qualities of all these parts are proved by the fact that they are widely pur-

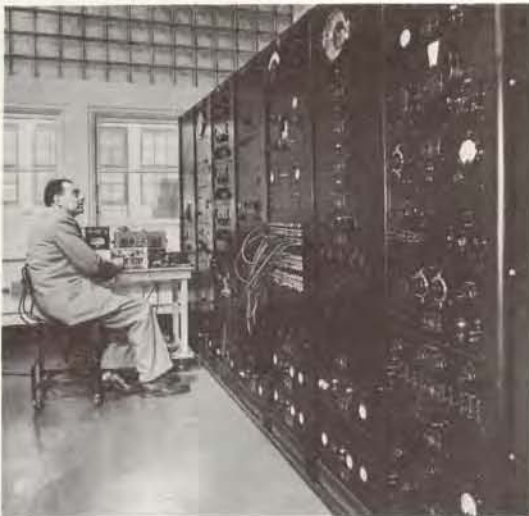

For more than 40 years, General Radio has been manufacturing standards for the electronics industry—resistance, capacitance, inductance, and frequency. Above is shown the primary frequency standard in the General Radio development laboratories.





chased as individual components by other manufacturers. Etched circuits provide the utmost reliability when carefully made. Those used in GR instruments are constructed to instrument-grade standards, have 0.003 inch copper on phenolic of not less than $\frac{3}{32}$ inch thickness and carry miniature sockets, made exclusively to General Radio specifications, which provide tube shield and satisfactorily resilient terminals. Rugged chassis and brackets are built to withstand military vibration tests as insurance against shipping and handling damage. Shielded leads are permanently terminated with a novel crimped-ferrule construction.

Cables, which add so much to the appearance of an instrument, are nylon-braided by a machine especially adapted at GR for the purpose. From the many materials tested, nylon has proved to be the best material, not only for its ability to wrap tightly and uniformly around any diameter, but also for its non-hygroscopic property.

All these parts and components and all the design practices characteristic of General Radio instruments are controlled by a comprehensive standards program, which keeps the number of different pieces, tools and procedures to an economic minimum, thereby making possible high quality at moderate prices. The standards program also includes constant study and testing to evaluate and to maintain quality. The manufacture of the products is carried out by skilled workmen aided by the most modern machinery, and quality is further assured by frequent stages of inspection.

SALES

Supporting and extending the quality that runs through General Radio design and manufacturing processes are the policies and op-

erations of the Sales Engineering Department. General Radio salesmen are engineering graduates—General Radio employees, factory trained and thoroughly familiar with the design, manufacture and use of GR products. They provide the connecting link between manufacturer and customer, translating customer needs into equipment recommendations and instrument capabilities into customer applications.

“We sell direct” is a long-established General Radio policy. The GR sales engineer is responsible, not only to his company, but also to the customer. His job is not only to sell GR products, but also to be sure that the customer buys the instrument best suited to his needs. Through this method of selling, the interests of both manufacturer and customer are best served.

SERVICE

Closely allied to Sales are the functions of the Service Department, which provides the continuity of contact between manufacturer and customer after a sale is made. Prompt, efficient, and satisfactory service when needed is an important factor in building and maintaining the customer's confidence.

PUBLICATIONS

A monthly publication, the *General Radio Experimenter*, brings to those interested up-to-date information on new developments, as well as technical information of a general nature. Sent free upon request, the magazine is distributed each month to more than 100,000 readers located in the United States and 83 foreign countries.

The General Radio Company zealously guards its reputation for integrity, ability, and quality, a reputation earned by over 43 years of fine-instrument manufacture.



Two views of Guarantee Tag.



POWER SUPPLY

General Radio a-c operated instruments will perform satisfactorily over their specified ranges of operation and within their specified accuracy when operated from power lines whose voltages and frequencies are within the limits stated in the specifications for the individual instruments under the heading "Power Supply".

► VOLTAGE

For most instruments the normal operating range is 105 to 125 volts. By a change in power-transformer primary connections, they can be altered to operate at 210 to 250 volts. A reversible plate at the power-input plug specifies the voltage for which the power transformer is connected, as well as the line frequency.

When 230- (i.e., 210 to 250) volt operation is specified in the order, the change in connections and plate is made at the factory. This change can also be made easily by the user, and instructions covering it are included in the operating instruction manual that accompanies the instrument.

When only 115-volt supply (i.e., 105 to 125 volts) is listed in the specifications, special models can be supplied for other voltages. Price and delivery information for voltages not listed will be furnished on request.



Views of reversible power-input voltage plate.

► VOLTAGE REGULATOR

Although tube plate voltages are regulated in many General Radio instruments, best and most stable performance is obtained when input line voltage is constant. When line voltage fluctuates (or is outside the specified operating range of the instrument), the use of a line-voltage regulator is recommended. The TYPE 1570 Automatic Voltage Regulators described on page 216 are excellent regulators for this service. Models are available for wall mounting, relay rack, or bench use. They handle *any load* up to 6 KVA, do not introduce waveform distortion, and are unaffected by load power factor.

► VARIAC® AUTOTRANSFORMER

Where only an occasional correction of line voltage is needed, manual adjustment by means of a Variac Adjustable Autotransformer is usually satisfactory. Available in ratings from 360-volt amperes to 7 KVA, these versatile transformers are described on pages 203-215.

► GROUNDED (THREE-WIRE) POWER CORDS

TYPE 109-A Power Input Plug.



Two- and three-wire cords connected to input plug.

As stated in the individual specifications, the power input plugs on most General Radio instruments (except those with permanently attached power cords) will accept either three-wire (TYPE CAP-15) or two-wire (TYPE CAP-35) power cords. The two-wire cord is supplied with the instrument; the three-wire cord is available as a separate item (see page 237) and should be so ordered.

► FREQUENCY

For most instruments, normal operating range is 50 to 60 cycles. In a few instruments the power supply will operate at frequencies as low as 40 cycles, as noted in the specifications. Special power supplies for 40 cycles and 25 cycles can be furnished in most instruments. Price and delivery will be quoted on request.

The majority of General Radio a-c operated instruments will operate satisfactorily at 400 cycles. As one would expect, regulation is often not so good as at lower frequencies, but instrument performance, in general, is not seriously impaired. Wherever high-frequency operation is recommended, the performance of each instrument, with any limiting conditions, is detailed in the individual specifications.

► BATTERY OPERATION

Portable instruments, such as sound-level meters, are normally operated from batteries. For these, a-c power packs are also available, as listed, each designed to replace a standard block battery.

TERMINALS AND CONNECTORS

Terminals and connectors used on General Radio instruments are, in most cases, of General Radio design and manufacture. Connectors of other manufacturers are used for specialized purposes, as, for instance, on broadcast, acoustic, and military equipment; and for plug-in power-supply connections.

▶ BINDING POSTS

Binding posts are General Radio TYPE 938, described on pages 238 to 239. These high-quality terminals were designed for use on General Radio instruments, where low dissipation factor, low capacitance, and minimum leakage are prime requirements. You will also find these binding posts on the products of many other manufacturers of quality equipment, to whom desirable electrical characteristics are important.



Spacing for a pair is $\frac{3}{4}$ " on centers, a standard established by General Radio some 35 years ago and now almost universally used. This spacing

fits the GR TYPE 274-MB Double Plug, whose banana-plug terminals fit into the jack tops of TYPE 938 Binding Posts.

▶ BANANA PLUGS AND JACKS



The widely used banana plug was first introduced in this country by General Radio in 1924. General Radio TYPE 274 Plugs and Jacks are designed for positive and reliable electrical contact and for mechanical stability; they are constructed of materials selected to assure these qualities. TYPE 274-MB Double Plugs, which consist

of two banana plugs set in molded styrene, are supplied with many General Radio instruments for facilitating input and output connections.



They are available separately, however, (see page 236) and will be found in educational, government, and industrial laboratories all over the world. Assembled on shielded cable (page 237) for use as patch cords, their usefulness is still further enhanced.

Single insulated plugs are also available and have many applications in patching connections.



▶ COAXIAL CONNECTORS

For coaxial input and output connections, the TYPE 874 Coaxial Connector is used. This connector is another outstanding General Radio development, with features that make it particularly desirable for instrument use. It is a universal type, with no separate male and female models. Every connector plugs smoothly into every other. Good contact, low losses, and low-standing wave ratio are its electrical features. The center conductor will accept a TYPE 274 Plug.



Cut-away view of two TYPE 874 Connectors joined together.

The TYPE 874 Coaxial Connector is also a common denominator for all other types. Adaptors to all AN types, as well as many others, make possible easy and simple connections to nearly all coaxial systems. These adaptors have very low standing-wave ratios, and two of them can be used to connect between two different AN systems, with the assurance that the introduced reflection loss will be very low.



Connection from a BNC Plug to a C Jack made possible by using two TYPE 874 Adaptors.

These connectors are available for rigid-line, cable, and panel installation. A locking clip makes possible rigid installations. Connectors, as well as a full line of coaxial elements, are described on pages 41 to 58.

SUGGESTIONS FOR ORDERING

ORDER BY TYPE NUMBER

Always order by catalog type number, and, whenever possible, mention name of item, ranges, or other significant specifications as protection against misunderstanding.

Be sure to include orders for any accessories desired or for calibrations which must be made before shipment. When minor modifications are desired to adapt the equipment to the customer's purposes, our Sales Engineering Department will be glad to discuss the details.

For EXPORT ORDERS please state the desired line-voltage and frequency. For example: 230 volts/50 c; 115 volts/50 c.

TELEGRAPH AND CABLE ORDERS

We have direct telegraph printer connections with Western Union for the prompt handling of messages.

Use the code words accompanying each catalog description. Our cable address is GENRADCO BOSTON.

ADDRESS

All communications, except when otherwise advised, should be sent to General Radio Company, West Concord, Massachusetts, to one of our district offices (see inside front cover), or to the appropriate export representative.

PACKING

There is no charge for our domestic packing or regular export packing and no charge for shipping containers or cases. Cases are not returnable.

SHIPPING INSTRUCTIONS

Unless specific instructions accompany the order, we shall use our judgment as to the best method of shipment. Repair parts or other items needed quickly can be shipped by air if requested. The following table shows approximate cost of four different methods of shipment to major cities in the United States, door-to-door.

Export Shipments via air-freight under 35 pounds are advantageous in many cases. They save transport costs and time. For example: the estimated charges, factory to Milan, Italy for the Type 1551-B Sound-Level Meter (Shipping weight, 15 pounds by air, 26 pounds by ocean freight) are \$24.35 for air-freight and \$46.00 for ocean carrier via New York. Air shipping weight is approximately 50 percent more than the net weight.

TERMS

All prices are F.O.B. West Concord, Massachusetts.

CONDITIONS OF SALE

Determination of prices, terms and condi-

CITY	2 POUNDS				5 POUNDS				25 POUNDS				40 POUNDS			
	Air Freight	Air Express	Air Parcel Post	Railway Express	Air Freight	Air Express	Air Parcel Post	Railway Express	Air Freight	Air Express	Truck or Rail Freight Forwarder	Railway Express	Air Freight	Air Express	Truck or Rail Freight Forwarder	Railway Express
BUFFALO	88.45	85.72	81.15	82.24	88.45	85.72	82.65	82.45	88.45	87.12	84.47	83.86	88.45	89.08	84.47	84.92
CLEVELAND	10.25	5.72	1.15	2.27	10.25	5.72	2.65	2.52	10.25	8.72	4.97	4.21	10.25	11.64	4.97	5.47
DETROIT	10.40	5.72	1.15	2.29	10.40	5.72	2.65	2.58	10.40	8.72	5.22	4.47	10.40	11.64	5.22	5.89
CHICAGO	11.60	5.72	1.26	2.31	11.60	5.72	2.94	2.65	11.60	11.12	5.72	4.82	11.60	15.48	5.72	6.44
ST. LOUIS	12.45	5.72	1.39	2.34	12.45	5.75	3.31	2.70	12.45	11.92	6.20	5.14	12.45	16.76	6.20	6.98
ATLANTA	12.45	5.72	1.26	2.27	12.45	5.72	2.94	2.52	12.45	11.12	5.39	4.51	12.45	15.48	5.39	6.06
HOUSTON	15.70	5.72	1.47	2.34	15.70	6.71	3.68	2.70	15.70	16.72	8.52	5.74	15.70	24.44	8.52	8.05
DALLAS	15.70	5.72	1.47	2.34	15.70	6.71	3.63	2.70	15.70	16.72	8.28	5.67	15.70	24.44	8.28	7.91
LOS ANGELES	21.85	5.73	1.60	2.33	21.85	7.99	4.00	3.00	21.85	23.37	11.14	7.43	21.85	34.68	11.14	10.74
SEATTLE	21.85	5.73	1.60	2.31	21.85	7.99	4.00	2.99	21.85	23.37	11.14	7.37	21.85	34.68	11.14	10.65

CITY	75 POUNDS				100 POUNDS				200 POUNDS				400 POUNDS			
	Air Freight	Air Express	Truck or Rail Freight Forwarder	Railway Express	Air Freight	Air Express	Truck or Rail Freight Forwarder	Railway Express	Air Freight	Air Express	Truck or Rail Freight Forwarder	Railway Express	Air Freight	Air Express	Truck or Rail Freight Forwarder	Railway Express
BUFFALO	\$10.75	\$15.69	\$4.47	\$7.41	\$10.75	\$16.97	\$4.47	\$9.17	\$16.55	\$33.94	\$7.42	\$18.34	\$30.48	\$67.88	\$14.84	\$36.68
CLEVELAND	12.75	18.49	4.97	8.44	12.95	23.37	4.97	10.55	20.65	46.74	7.72	21.10	39.48	93.48	15.44	42.20
DETROIT	13.15	18.49	5.22	9.20	13.87	23.37	5.22	11.57	22.84	46.74	8.80	23.14	43.76	93.48	17.00	46.28
CHICAGO	14.85	25.69	5.72	10.24	16.40	32.97	5.72	12.94	27.70	65.94	9.60	25.88	53.08	131.88	19.20	51.76
ST. LOUIS	16.20	28.09	6.20	11.26	18.05	36.17	6.20	14.31	31.15	72.34	10.68	28.62	59.88	144.68	21.36	57.24
ATLANTA	16.20	25.69	5.39	9.71	16.95	32.97	5.39	12.32	28.95	65.94	10.78	24.64	55.48	131.88	21.56	49.28
HOUSTON	21.20	42.49	8.52	13.44	24.10	55.37	8.52	17.28	43.50	110.74	14.20	34.56	85.28	221.48	28.40	69.12
DALLAS	21.20	42.49	8.28	13.19	25.16	55.37	8.28	16.97	45.62	110.74	13.80	33.94	89.12	221.48	27.60	67.88
LOS ANGELES	30.55	61.69	11.14	18.48	33.00	80.97	11.14	24.00	61.15	161.94	22.28	48.00	120.68	323.88	44.56	96.00
SEATTLE	30.35	61.69	11.14	18.31	32.26	80.97	11.14	23.78	60.67	161.94	22.28	47.56	137.72	323.88	44.56	95.12



tions of sale, and final acceptance of orders are made only at our factory, West Concord, Massachusetts.

Domestic Terms: Net 30 days if credit has been arranged; otherwise unless payment is received before shipment, shipment will be made C.O.D.

When full payment accompanies an order for equipment, except for repairs, we pay transportation charges to any point in the continental United States (not including Alaska and the Canal Zone) on carrier of our choice.

Export Terms: Full payment in advance of shipment or by sight-draft against irrevocable letter of credit at New York or Boston bank.

REMITTANCES

Should be made payable at par in Boston or New York funds.

PRICE CHANGES

All prices are subject to change without notice. Formal price quotations remain open for 30 days.

Prices shown will be increased by the amount of any applicable sales, use, excise, or similar taxes that are now in effect or that may hereafter be imposed by Federal, State, or local governments.

NO TRADE OR EDUCATIONAL DISCOUNTS

Our prices are established on a direct-to-customer basis, which permits no special discounts. By the elimination of distribution or resale discounts, all users pay the lowest possible prices.

QUANTITY DISCOUNTS

When 10 or more identical parts (not instruments) are ordered at the same time for single shipment to a single destination in the continental United States (not including Alaska and the Canal Zone) and Canada, the following quantity discounts are allowed except as noted otherwise:

10-19	5 percent
20-99	10 percent
100 or more	15 percent

Questions regarding the applicability of quantity discounts to any item in this catalog will be answered promptly by our Sales Engineering or Commercial Departments.

SPECIFICATION CHANGES

We reserve the right to discontinue any

item without notice and to change specifications at any time without incurring any obligation to incorporate new features in instruments or parts previously sold.

WARRANTY

We warrant that each new instrument sold by us is free from defects in material and workmanship and that properly used it will perform in full accordance with applicable specifications for a period of *two years* after original shipment. Any instrument or component that is found within the two-year period not to meet these standards after examination by our factory, district office, or authorized repair agency personnel will be repaired or, at our option, replaced without charge, except for tubes or batteries that have given normal service.

REPAIR PARTS

When ordering repair parts, be sure to describe completely the parts required, also refer to the symbol numbers and description from the parts list, and give the type number and serial number from the panel of the instrument.

RETURNED MATERIAL

Repair service is available from the factory, West Concord, Mass., or from the Repair Services listed on the inside front cover of this catalog.

When returning instruments for repair, recalibration, or for any other reason, please ask for Return Material Tag and shipping instructions. Please state type number and serial number of the instrument and date of purchase.

DOMESTIC SALES AGENCIES

Because of our direct-sales policy no general sales agencies are appointed. Complete stocks are carried only at the factory warehouse. Partial stocks are maintained at all of our district offices (see inside front cover).

EXPORT REPRESENTATIVES

Export sales are handled by resident representatives in most overseas countries. Complete technical and commercial information is available from these representatives, at the addresses listed on the inside back cover of the catalog.



VISIT OUR LABORATORIES AND FACTORY

We cordially invite you to visit our engineering laboratories and factory.

HOURS FOR VISITORS: 10:00 A.M. to 4:00 P.M. every day except Saturdays, Sundays, and legal holidays in Massachusetts.

Our plant is located in West Concord at 22 Baker Avenue. This is a short distance from the intersection of State Routes 2 and 62, and the accompanying map gives details of this area.

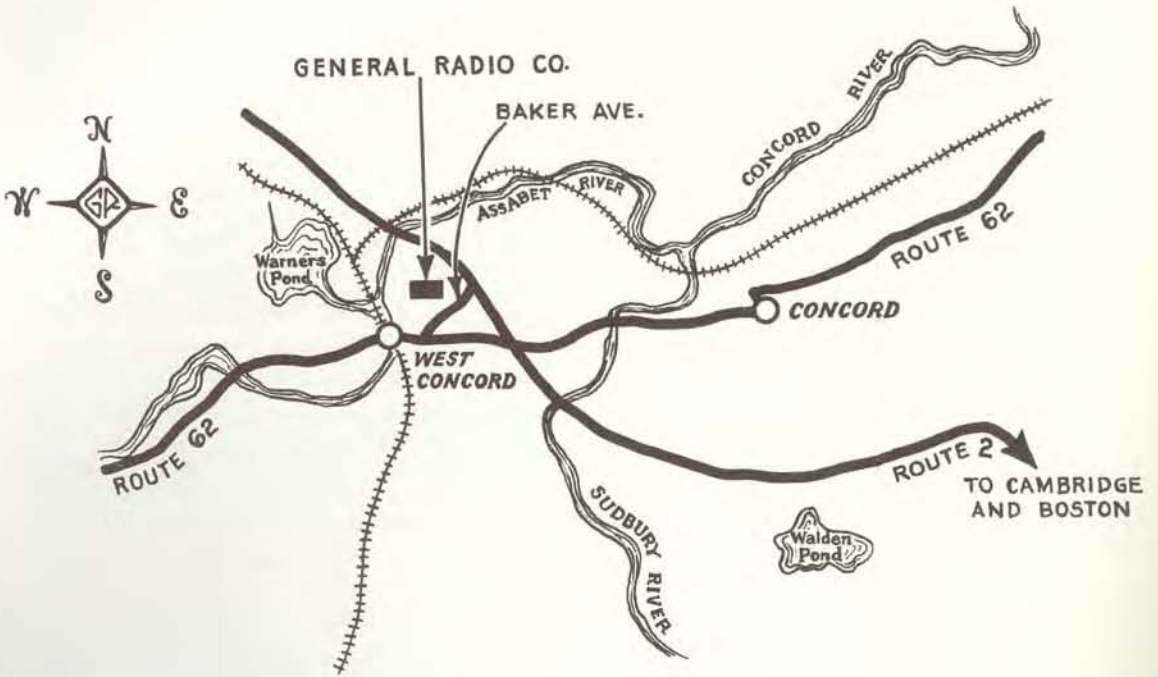

PATENTS

Many of our products are manufactured and sold under United States Letters Patent owned by the General Radio Company or under license grants from other companies. To simplify the listing of these patents they are given here in a single list and referred to at each instrument only by appropriate reference number.

1. "Certain vacuum-tube amplifier devices, electric wave filters, vacuum-tube oscillators, and sound-level meters are licensed by Western Electric Company, Inc., under all United States Letters Patent owned or controlled by American Telephone and Telegraph Company, or Western Electric Company, Inc., and any or all other United States patents with respect to which Western Electric Company, Inc., has the right to grant a license, solely for utilization in research, investigation, measurement, testing, instruction, and development work in pure and applied science, including engineering and industrial fields."

2. "This apparatus uses inventions of United States Patents licensed by Radio Corporation of America. Patent numbers supplied upon request. Licensed only for

use in measuring or testing electronic devices, electron tube circuits, parts of such devices and circuits, and elements for use in such devices and circuits."

3. Patent D 161,030.
4. Patent 2,548,457.
5. Patent 2,802,907.
6. Licensed under designs, patents and patent applications of Edgerton, Germeshausen and Grier.
7. Patent 2,294,941.
8. Patent Applied For.
9. Patent Re 24,204.
10. Patent 2,367,681.
11. Patent 2,374,248.
12. Patent 2,376,394.
13. Patents D 142,777 and D 143,807.
14. Patent 2,763,733.
15. Patent 2,298,177.
16. Patent 2,362,503.
17. Patent 2,354,718.
18. Patent 2,581,133.
19. Patent 2,872,639.

IMPEDANCE-MEASURING INSTRUMENTS



For the measurement of all types of impedance, resistive or reactive, inductive or capacitive, at frequencies well up into the uhf band, null methods have proved to be the most acceptable on grounds of both precision and convenience. Most of the null methods used from dc to radio frequencies of the order of 100 megacycles are adaptations of the fundamental Wheatstone bridge circuit, although other types of networks which can be adjusted to give zero transmission are sometimes used. Other systems, such as resonant circuits, using deflection-type instruments also have advantages for certain applications.

At very-high and ultra-high frequencies, where impedances can no longer be treated as lumped elements, coaxial lines are more suitable than bridge circuits made up of lumped elements, and null-type instruments employing these techniques have been developed in the General Radio laboratories. Impedance can also be determined at these frequencies from a measurement of the standing-wave ratio that the unknown element introduces into a smooth transmission line. Slotted lines for this measurement are described in the coaxial equipment section.

DIRECT-CURRENT BRIDGES

The so-called Wheatstone bridge, Figure 1, has been used for over a century for the measurement of direct-current resistance and is still considered the fundamental circuit for the purpose. It measures an unknown resistance in terms of calibrated standards of resistance from the relationship

$$\frac{R_A}{R_B} = \frac{R_N}{R_P} \quad (1)$$

which is satisfied when the voltage across the detector terminals is zero.

The General Radio Company manufactures three d-c Wheatstone bridges:

Type	Name	Range of Measurement	Accuracy	Remarks	See Page
1650-A	Impedance Bridge	1 mΩ to 1 MΩ	±1% ± 1 mΩ	Also measures ac R, L, C	24
1652-A	Resistance Limit Bridge	1 Ω to 1 MΩ	0.5% as limit bridge 0.25% by null method	Equally useful as production or laboratory bridge	6
544-B	Megohm Bridge	0.1 MΩ to 1 MMΩ	3% up to 1000 MΩ	Excellent for measuring resistors and insulation resistance	8

ALTERNATING-CURRENT BRIDGES

The basic circuit of Figure 1 is also applicable to alternating-current measurements. With impedances substituted for resistances, two conditions of balance must be satisfied, one for the resistive component and one for the reactive component. The equations of balance can be written in either of the following forms:

$$R_N + jX_N = Z_A Z_P Y_B \quad (2)$$

$$G_N + jB_N = Y_A Y_P Z_B \quad (3)$$

Equation (2) expressed the unknown in terms of its impedance components, while Equation (3) expresses the unknown in terms of its admittance components. To sat-

isfy these equations, at least one of the three arms A, P, or B must be complex.

The reactance X_N can be measured in terms of a similar reactance in an adjacent arm or an unlike reactance in the opposite arm, as indicated in Figure 2.

Resistive Balance

Figure 3 shows the four basic methods in common use for balancing the loss component of the unknown impedance. These are (1) resistance in series with the standard reactance, (2) resistance in parallel with the standard reactance, (3) capacitance in parallel with a resistive arm, and (4) capacitance in series with a resistive arm.

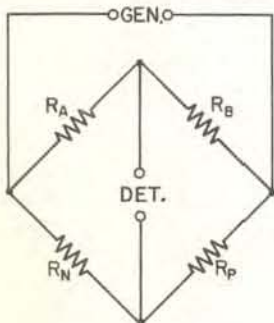

(Left) FIGURE 1. The general Wheatstone bridge circuit.
(Right) FIGURE 2. Circuits for capacitance bridges in which like reactances, C_N and C_P , or unlike reactances, L_A and C_P , are compared.

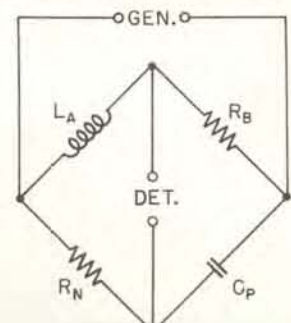
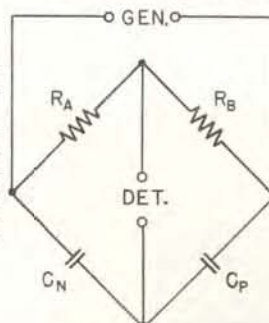

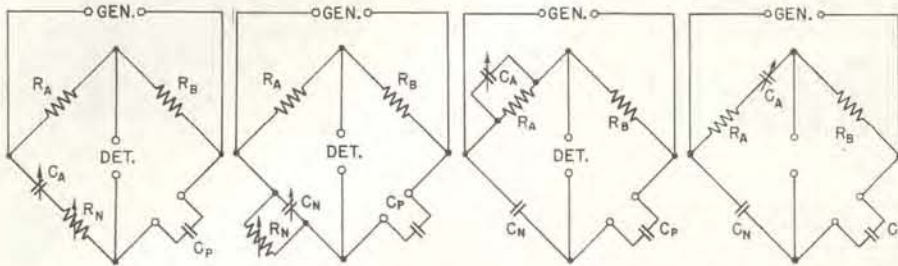

FIGURE 3. Four basic methods of obtaining resistance balance.

Dissipation Factor and Storage Factor

An important characteristic of an inductor or a capacitor is the ratio of resistance to reactance or of conductance to susceptance. This ratio is termed dissipation factor, *D*, and its reciprocal is storage factor, *Q*. These ratios are defined in Figure 4 in terms of phase angle θ and loss angle δ . Dissipation factor is directly proportional to the energy dissipated, and storage factor to the energy stored, per cycle. Power factor is defined as

$$P. F. = \cos \theta = \sin \delta$$

and differs from dissipation factor by less than 1% when their values are less than 0.1.

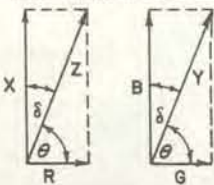

$$D = \cot \theta = \frac{R}{X} = \frac{G}{B} = \frac{1}{Q} = \tan \delta$$

$$\text{Power Factor} = \cos \theta = \frac{R}{Z}$$

$$Q = \tan \theta = \frac{X}{R} = \frac{B}{G} = \frac{1}{D} = \cot \delta$$

FIGURE 4. Vector diagram showing the relations between factors *D* and *Q*, and angles θ and δ .

In Figure 4, *R* & *X* are the series resistance and reactance, and *G* and *B* are the parallel conductance and susceptance of the impedance or admittance involved.

Dissipation factor, which varies directly with the loss, is commonly used for capacitors and, to a lesser extent, for inductors. Its reciprocal, storage factor, *Q*, is more often used for inductors, because it is a measure of the voltage step-up in a tuned circuit.

The circuit can often be arranged so that the bridge control for the resistive balance can be calibrated in dissipation factor or in storage factor, for a given frequency.

Series and Parallel Components

Every impedance can be expressed in terms of either series or parallel components. The choice is a matter of convenience for the problem at hand. One cannot tell from a single measurement whether a combination of a resistive and a reactive element are actually in parallel or in series, and, regardless of the physical configuration, the resistive and reactive components can be measured as, and expressed as, (1) series impedance components, (2) parallel impedance components, or (3) admittance components.

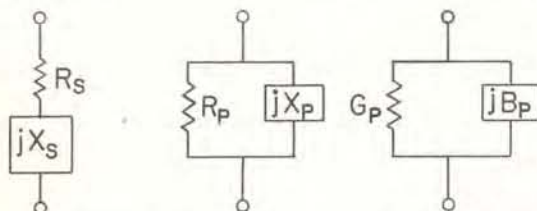

FIGURE 5. Series and parallel components of impedance.

The relation between these various systems (see Figure 5) are:

$$R_p = \frac{1}{G_p} = \frac{R_s^2 + X_s^2}{R_s} = R_s (1 + Q^2)$$

$$X_p = \frac{1}{B_p} = \frac{R_s^2 + X_s^2}{X_s} = X_s (1 + D^2)$$

So that:

$$C_p = C_s \left(\frac{1}{1 + D^2} \right); C_s = C_p (1 + D^2)$$

$$L_p = L_s \left(1 + \frac{1}{Q^2} \right); L_s = L_p \left(\frac{Q^2}{1 + Q^2} \right)$$

Where:

$$Q = \frac{X_s}{R_s} = \frac{R_p}{X_p} = \frac{B_p}{G_p} \quad D = \frac{1}{Q} = \frac{R_s}{X_s} = \frac{X_p}{R_p} = \frac{G_p}{B_p}$$

It should be noted that only for values of *Q* below 10 (or *D* > .1) does the difference between series and parallel reactance exceed 1%. For very low *Q*'s, however, the difference is marked; when *Q* = 1, the parallel reactance is twice the series reactance. It is obvious that if there were no losses in the reactive elements, (i.e., *Q* = ∞) series and parallel reactance would be equal.

Whether a bridge measures series or parallel components depends upon its own configuration of elements. Measurements with the bridge shown in Figure 3b, for example, will yield parallel values for the unknown. Similarly the bridge of Figure 3a will give series values.

Substitution Methods

Substitution methods of measurement, as contrasted to the direct method described, can be used to advantage with all ac bridges. In this method the unknown is measured in terms of the difference between two settings of a calibrated resistance or reactance. In the measurement of capacitance by a parallel substitution method, for instance, as shown in Figure 6, the unknown capacitance is connected in parallel with an adjustable calibrated capacitor in either the N- or P-arm of the previously balanced bridge, and the calibrated element is readjusted until the bridge is again in balance.

Increased accuracy in the capacitance measurement results from the fact that the measurement is solely in terms of the difference between two settings of a calibrated precision capacitor, the bridge circuit functioning only as an indicator of identical balance conditions. The bridge circuit does, however, enter into the determination of dissipation factor.

The series substitution method of Figure 7 is used to make resistance and reactance dials direct reading in ohms.

TRANSFORMER BRIDGES

Transformer windings, which can provide extremely precise voltage ratios, will perform the same function as ratio arms in conventional bridge circuits. They have the further advantage of very low impedance to ground, which greatly lessens the effects of stray shunt impedances, and, in the TYPE 1613-A Capacitance Bridge, obviates the need for a guard circuit when 3-terminal capacitors are measured. Transformers are used in both the TYPE 1605-A Impedance Comparator and the TYPE 1613-A Capacitance Bridge.

LIMIT BRIDGES AND COMPARATORS

In limit testing the unbalance voltage of the bridge is used to actuate meters that indicate the degree of deviation of one impedance from another. This method

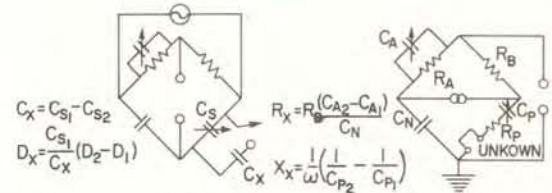

(Left) FIGURE 6. Parallel substitution method of measurement. (Right) FIGURE 7. Circuit for series substitution method.

is used in the TYPE 1652-A Resistance Limit Bridge and the TYPE 1605-A Impedance Comparator. External equipment can be connected for automatic sorting.

A-C BRIDGES

Type	Name	Measures	Nominal Accuracy	Frequency	Remarks	See Page
Power-Frequency Bridges						
1611-B	Capacitance Test Bridge	C 0 to 11,000 μ f D 0 to 60%	$\pm 1\%$ $\pm 2\%$	60, 120 c	For testing insulators, bushings, capacitors, cables, and polarized electrolytic capacitors. Measures grounded capacitors.	18
740-B	Capacitance Test Bridge	C 5 μ f to 1100 μ f D 0 to 50%	$\pm 1\%$ $\pm 1.5\%$	60c	Measures ungrounded capacitors.	17
Audio-Frequency Bridges						
1650-A	Impedance Bridge	R 1m Ω to 1 M Ω C 1 μ f to 1000 μ f L 1 μ h to 1000 h Also D and Q	$\pm 1\%$ $\pm 1\%$ $\pm 1\%$	dc, 1 kc	Completely self-contained, general purpose, laboratory and production bridge. Belongs in every laboratory and electronic plant.	24
1603-A	Z-Y Bridge	R, X 0-1000 Ω G, B 0-1000 μ mho	$\pm 1\%$ $\pm 1\%$	20 c-20 kc	Will balance for any impedance from 0 to ∞ . Ideal for measuring audio-frequency transducers.	28
716-C	Capacitance Bridge	C 100 μ f to 1 μ f C 100 to 1000 μ f C 0.1 to 1000 μ f D 0.00002 to 0.56	$\pm 0.1\%$ $\pm 0.1\%$ $\pm 0.2\%$ $\pm 2\%$	1 kc 0.1 to 100 kc 0.1 to 100 kc 0.1 to 100 kc	Direct Reading Direct Reading Substitution Method	10
1613-A	Capacitance Bridge	C 5 μ f to 0.011 μ f D 0 to 0.11	$\pm 0.1\%$ $\pm 2\%$	400 c	Measures 3-terminal capacitors.	20
1632-A	Inductance Bridge	L 0.001 μ h to 1111 h G 0.01 μ mho to 1111 mho	$\pm 0.1\%$ $\pm 1\%$	1 kc	Measures both series and parallel inductance.	22
1605-A	Impedance Comparator	$\Delta Z \pm 0.01\%$ to $\pm 10\%$ $\Delta \theta \pm 0.001$ to ± 0.1 radian	$\pm 0.01\%$	0.1, 1, 10, 100 kc	Direct indication on meters, no balancing. Guard circuit included.	26
Radio-Frequency Bridges						
716-CS1	Capacitance Bridge	C 0.1-1100 μ f D 0.00002 to 0.56	$\pm 0.1\%$ $\pm 2\%$	0.5 to 3 Mc	High-Frequency model of TYPE 716-C.	12
916-AL	Radio Frequency Bridge	X $\pm 11,000 \Omega$ at 100 kc R 0 to 1000 Ω	$\pm 2\%$ $\pm 1\%$	50 kc to 5 Mc	Use for measuring antennas, lines, components.	32
1606-A	Radio Frequency Bridge	X $\pm 5000 \Omega$ at 1 Mc R 0 to 1000 Ω	$\pm 2\%$ $\pm 1\%$	0.4 to 60 Mc	Use for measuring antennas, lines, components.	30
1601-A	VHF Bridge	X $\pm 200 \Omega$ at 100 Mc R 0 to 200 Ω	$\pm 5\%$ $\pm 2\%$	10 to 165 Mc	For measurements on both lumped and coaxial circuits.	33

For a more complete discussion of bridge circuits see "Impedance Bridges Assembled from Laboratory Parts," by Ivan G. Easton. Copy free on request.

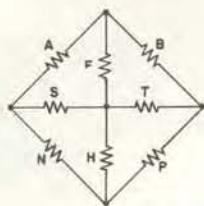

(Left) FIGURE 8. General bridge network with guard circuit, and unknown three-terminal impedance. (Right) FIGURE 9. Elementary schematic circuit diagram of the TYPE 716-P4 Guard Circuit connected to the TYPE 716-C Capacitance Bridge showing the unknown capacitance and its terminal impedances.

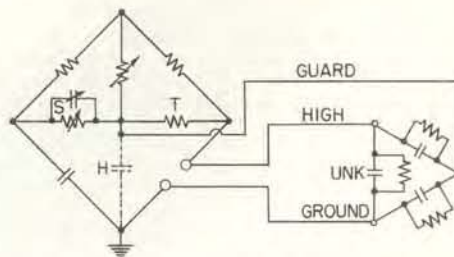

Guard Circuit

Whenever the impedance to be measured is located at an appreciable distance from the bridge, or when it has appreciable capacitance from its terminals to ground, a guard circuit may be used to eliminate the effects of the unwanted residual impedances. Figure 8 is a schematic of a generalized bridge network with guard circuit. It can be shown that the network is in balance if either of the following conditions are met:

$$\frac{A}{N} = \frac{B}{P} = \frac{F}{H} \quad \frac{A}{B} = \frac{N}{P} = \frac{S}{T}$$

Obviously these conditions include the ordinary equation of balance of the four-arm network A-B-N-P.

Figure 9 shows the schematic diagram of the TYPE 716-P4 Guard Circuit, designed specifically for use with the 716-C Capacitance Bridge. In this circuit the guard point is brought to ground potential, as is the detector terminal. This particular type of guard circuit has been

frequently referred to in literature as a Wagner Ground. Since the high lead is shielded, capacitance between the leads does not enter the measurement. Capacitance from high lead to shield becomes part of the impedance T. Impedance H is supplied by the capacitance of the low terminal of the unknown to its shield.

The use of the guard circuit permits the accurate measurement of the direct capacitance and dissipation factor between two terminals of a three-terminal network. One of the most important applications of such a measurement arises in the determination of the properties of dielectric materials. A guard electrode, which forms, with the two measuring electrodes, a three-terminal system, is often employed in such determinations to eliminate effects of variable lead parameters as temperature or other conditions are changed. A guard circuit, TYPE 716-P4, is available for use with the TYPE 716-C Capacitance Bridge, and guard terminals are provided on the TYPE 544-B Megohm Bridge and the TYPE 1605-A Impedance Comparator.

COAXIAL LINE INSTRUMENTS

Type	Name	Measures	Nominal Accuracy	Frequency	Remarks	See Page
1602-B	Admittance Meter	B, G 0.1 to 1000 mmhos X, R 1 to 10,000 ohms	±3%	20 to 1500 Mc	For measurements on coaxial lines, antennas, networks, components	34
1607-A	Transfer Function and Immittance Bridge	Z ₂₁ 0 to 1500 ohms Y ₂₁ 0 to 600 mmhos V ₂ /V ₁ 0 to 30 I ₂ /I ₁ 0 to 30 B, G 0 to 400 mmhos X, R 0 to 1000 ohms	±2.5%	25 to 1500 Mc	Measures four-terminal transfer functions of tubes, transistors and networks; also 2-terminal functions.	36
874-LBA	Slotted Line	VSWR	3% or better	300 to 5000 Mc	Standard instrument for uhf impedance measurement	43
874-LM	Dielectric Measuring Line	K D	±2% ±5%	200 to 5000 Mc	Cylindrical Samples	46

The Admittance Meter

The upper-frequency limit of conventional bridge circuits using lumped-parameter elements is determined by the magnitude of the residual impedances of the elements and leads. In general, the corrections for these become unmanageable at frequencies higher than a few hundred megacycles, and circuits based on coaxial-line techniques are more satisfactory.

The TYPE 1602-B UHF Admittance Meter (see page 34) is a null device based on these techniques. Through adjustable loops, it samples the currents flowing in three coaxial lines fed from a common source at a common junction point and terminated, respectively, in the unknown element, a standard conductance, and a standard susceptance. The outputs of the loops are combined, and when the loops are properly oriented, the combined output be-

comes zero, so that a null balance is produced. Scales associated with the three loops give the value of the unknown directly.

The Transfer Function and Immittance Bridge

Like the Admittance Meter, the Transfer Function and Immittance Bridge is a null instrument using coaxial lines and adjustable coupling loops. A schematic is shown on page 37. It can measure 4-terminal functions, such as forward and reverse transconductance and transsusceptance, transimpedance, input-output ratios of voltage and current, and output-input ratios, as well as the 2-terminal functions of admittance and impedance.

This instrument is particularly useful for evaluating the transfer functions of vacuum tubes and transistors in the vhf and uhf ranges.



The Slotted Line

One of the basic methods of determining impedance of a coaxial device is the measurement of the standing-wave ratio it introduces into a smooth line. The measurement is made by means of a coaxial line in whose outer conductor is a longitudinal slot. An electrostatic probe enters the line through this slot and can be moved along the line to

sample the electric field between the inner and outer conductors. From the voltage maximum and minimum, and their location with respect to the unknown, the impedance can be calculated.

The TYPE 874-LBA Slotted Line for General impedance measurement and the TYPE 874-LM Dielectric Measuring Line are described in the Coaxial Section, pages 41 to 58.

DETECTORS

(See also the discussion of detectors on page 60).

To obtain the maximum precision of balance with any bridge or null-balance circuit, it is necessary to obtain a virtually complete null balance. With modern amplifiers, however, sufficient sensitivity can be obtained to utilize all the potential precision of any null-balance network, even with relatively low applied bridge voltage.

The desirable characteristics of a bridge detector are:

- (1) High sensitivity, preferably the ability to detect a few microvolts.
- (2) High selectivity, to reject harmonics, noise, or other interfering signals. This is particularly important in measuring iron-cored coils and other non-linear elements.

(3) Quasi-logarithmic response, to obviate the necessity of gain adjustments during the balancing procedure. These requirements are best met by some combination of amplifier, filter, and null indicator. At audio frequencies, an amplifier, with either fixed or tunable filters, and either a meter or earphones, is satisfactory. (TYPE 1231-BRFA) With visual indicators, such a system can also be used at frequencies up to several megacycles (TYPE 1212-A).

From a few hundred kilocycles to some 40 megacycles, well-shielded radio receivers make excellent detectors, while at very-high and ultra-high frequencies the preferred system is a heterodyning oscillator, mixer, and fixed-frequency i-f amplifier (TYPE DNT).

GENERATORS

The important considerations in the selection of a power source for ac bridge measurements are good frequency stability, adequate power output, and low harmonic content. For those General Radio bridges that require external generators, a wide choice is available.

For single-frequency measurements at 400 or 1000

cycles, the TYPE 1214-A and TYPE 723-C Oscillators are satisfactory. For a wide range of low frequencies, the TYPES 1304-B, 1210-C, and 1302-A are recommended. At low and medium frequencies the TYPE 1330-A Bridge Oscillator, and at frequencies above 0.5 Mc, and up to 2000 Mc, the various Unit Oscillators are recommended.

CONNECTIONS-SHIELDING

Adequate ground connection and shielded generator and detector leads are necessary precautions in any bridge measurements, but are particularly important at high frequencies. At audio and low-radio frequencies, electrostatic shielding of the leads is usually all that is

necessary; above a few megacycles, coaxial leads must be used, and these must be securely grounded to the detector, generator, and bridge shields to provide a completely shielded system, and to eliminate common impedances between generator and detector.

SPECIALIZED MEASUREMENTS

Vacuum Tubes and Transistors

No single device will measure all the desired characteristics of tubes and transistors, nor will it measure any one property at all frequencies. The fundamental vacuum tube parameters—plate resistance, amplification coefficient, and transconductance—are measured easily and accurately at low frequencies by the TYPE 1661-A Vacuum-Tube Bridge. Of transistors, it will measure the short-circuit conductance parameter, including the h_i hybrid parameter, and the forward and reverse voltage ratios, including the h_r hybrid parameter. The h_f , α , and β factors as well as other open-circuit parameters can be calculated from these measurements.

At very-high and ultra-high frequencies the TYPE

1607-A Transfer Function and Immittance Bridge measures important parameters of both tubes and transistors. For transistors, these include short-circuit current gain, open-circuit voltage-feedback factor, hybrid input impedance and hybrid output admittance. For tubes, they include open-circuit voltage gain, transadmittance, feedback admittance, and input and output admittance. These last two quantities can be measured at low frequencies by the TYPE 1603-A Z-Y Bridge.

Type	Name	See Page
1661-A	Vacuum-Tube Bridge	39
1607-A	Transfer Function and Immittance Bridge	36
1603-A	Z-Y Bridge	28

Dielectric Measurements

For the measurement of the dielectric constant and dissipation factor of insulating materials, the TYPE 716-C Capacitance Bridge is recommended at low frequencies (up to 100 kc), the TYPE 716-CS1 up to 5 Mc, and the TYPE 874-LM Dielectric Measuring Line at very-high and ultra-high frequencies. With the bridges, the TYPE 1690-A Dielectric Sample Holder is useful in 2-terminal measurements. The TYPE 716-P4 Guard Circuit can be used with the TYPE 716-C Capacitance Bridge when the

sample is in a conditioning chamber, or, alternatively, the TYPE 1605-A Impedance comparator, with its built-in guard, can be used for the measurement.

Type	Name	See Page
716-C	Capacitance Bridge	10
716-CS1	Capacitance Bridge	12
874-LM	Dielectric Measuring Line	46
1605-A	Impedance Comparator	26
1690-A	Dielectric Sample Holder	16





TYPE 1652-A RESISTANCE LIMIT BRIDGE

A LIMIT BRIDGE FOR RAPID TESTING A WHEATSTONE BRIDGE FOR THE LABORATORY

USES: The Resistance Limit Bridge is intended primarily for the production testing of resistors. It can be used—

- To indicate percentage deviation from an internal standard.
- To match pairs of resistors.
- To compare resistors to a standard sample.
- To measure resistance precisely by the null method.

For manufacturers and users of resistors, this bridge offers an accurate and rapid means of separating resistors into tolerance classifications and for selecting resistors to close tolerances. The manufacturer of electronic equipment can use it to advantage in matching pairs of resistors for operation in balanced circuits.

Its accuracy is adequate for all but the most exacting requirements in the laboratory, and its ability to measure resistors as large as one megohm without the inconvenience of adding booster batteries makes it much more convenient than the ordinary decade bridge.

The bridge can also be adapted for use as the control unit in automatic sorting or inspecting. A relay, in conjunction with external amplification, can be substituted for the indicating meter, to actuate various types of selection mechanisms. By adjustment of the sensitivity of the relay, end points can be es-

tablished to determine tolerances such as $\pm 5\%$, $\pm 10\%$, and $\pm 20\%$.

DESCRIPTION: The TYPE 1652-A Resistance Limit Bridge uses the conventional equal-arm Wheatstone bridge circuit. The bridge is supplied from a constant-voltage dc source, and its indicating meter is calibrated in percentage difference between the unknown and the standard over a range of $\pm 20\%$.

A built-in standard consisting of seven TYPE 510 Decade Resistors is adjustable from one ohm to 1,111,111 ohms in 0.1-ohm steps.

Measurements are made simply; the standard is set to the nominal value of the resistor under test, and the percentage difference is indicated on the meter. This test procedure can

Schematic circuit diagram of the Type 1652-A Resistance Limit Bridge.

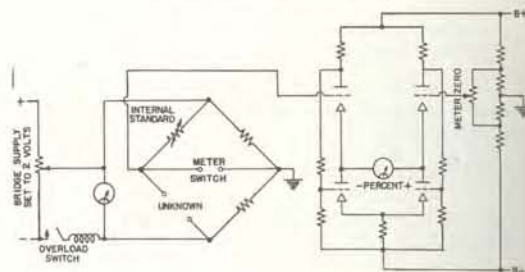



be greatly facilitated by the use of a test fixture into which the resistors can be plugged, and which can be operated in conjunction with a switch that shorts the meter circuit prior to removal of the resistor from the jig. Panel terminals for such a switch are provided.



Resistance Limit Bridge used for production testing of potentiometers.

For the matching of resistors, the resistor to be matched is connected to terminals provided and the internal standard is set to zero.

Used as a conventional Wheatstone bridge, the circuit is balanced by adjustment of the internal standard to equality with the unknown resistor; the calibrated meter is used as a null indicator.

FEATURES:

- Rapid and accurate for limit tests.
- Extreme simplicity of operation.
- Large meter scale, colored gold for 5% limits and silver for 10% limits.
- Equally useful for general resistance measurement.
- Covers a wide resistance range—one ohm to one megohm.
- No batteries required. Operates from 115-volt or 230-volt, 60-cycle line.
- Ruggedly constructed and enclosed in welded aluminum cabinet.
- Accurate—can measure resistors to an accuracy of $\pm 0.25\%$.
- Indicating meter can not be damaged by unbalance of bridge.

SPECIFICATIONS

Resistance Range: As a limit bridge, 1 ohm to 1,111,111 ohms with internal standard; for null measurement, 1 ohm to 1,111,111 ohms with internal standard; 1 ohm to 2 megohms with external standard.

Limit Range: Meter reads from -20% to $+20\%$, with the standard EIA tolerance range of $\pm 5\%$ and $\pm 10\%$ clearly indicated by gold and silver coloring, respectively.

Accuracy: As a limit bridge, $\pm 0.5\%$ or better; for matching, $\pm 0.2\%$; for null measurement, with internal standard, $\pm 0.25\%$ above 10 ohms and $\pm 0.4\%$ between 1 ohm and 10 ohms; with an external standard, from 1 ohm to 2 megohms ($\pm 0.2\%$ + accuracy of standard).

Voltage Applied to Unknown: The voltage across the unknown resistor is exactly one volt when the meter indication is zero. As the meter indication varies from

-20% to $+20\%$ the voltage across the unknown will vary from 0.89 volt to 1.10 volts.

Power Supply: 105 to 125 volts or 210 to 250 volts, 60 cycles. The power input is approximately 30 watts. Power input receptacle will accept either 2-wire (TYPE CAP-35) or 3-wire (TYPE CAP-15) power cord. Two wire cord is supplied. For 3-wire, see page 237.

Accessories Supplied: TYPE CAP-35 Power Cord and spare fuses.

Tube Complement: One TYPE 6X4 and two TYPE 6SU-7GY's. All are supplied with the instrument.

Mounting: The bridge is supplied for either relay rack or bench mounting. Cabinet has wrinkle finish.

Dimensions: Panel, $19 \times 8\frac{3}{4}$ inches; depth behind panel; bench model, $11\frac{1}{4}$ inches; relay-rack model, $10\frac{3}{4}$ inches.

Net Weight: 29 pounds.

Type		Code Word	Price
1652-AM	Resistance Limit Bridge (Bench Model)	BUXOM	\$495.00
1652-AR	Resistance Limit Bridge (Relay-Rack Model)	BADGE	495.00
1652-AMQ1	Resistance Limit Bridge (50 cycles).....	BUXOMRABID	620.00
1652-ARQ1	Resistance Limit Bridge (50 cycles).....	BADGERABID	620.00

MEGOHM BRIDGE: A Wheatstone bridge for the megohm range, capable of measurements from 0.1 megohm to 1,000,000 megohms, is described on page 8.

A-C LIMIT BRIDGE: The Type 1605-A Impedance Comparator (page 26) is designed for the rapid comparison of resistors, capacitors and inductors at 0.1, 1, 10, and 100 kc.



TYPE 544-B MEGOHM BRIDGE

MEASURES:

**INSULATION RESISTANCE
RESISTIVITY
DIELECTRIC ABSORPTION**



USES: The megohm bridge is very useful for the measurement of all types of resistances in the megohm ranges. These include not only the resistance of composition, film, and carbon resistors, but also the insulation resistance of electrical machinery such as generators, motors, and transformers; of electrical equipment such as rheostats and household appliances; of single conductors, cables, and capacitors; of sufficiently long sections of

high-voltage cables; of paper capacitors; and of slabs of insulating materials.

Volume resistivity and its change with temperature and humidity can also be determined.

Guard connections are provided for the measurement of three-terminal resistors such as multi-wire cables, three-terminal capacitors, networks, and guarded specimens of insulating materials.

This bridge has been widely used for measuring the dielectric absorption effects in the insulation of electrical machinery, transformers, and cables. Charging-current curves can be easily obtained over time intervals from one second to many hours.

DESCRIPTION: The TYPE 544-B Megohm Bridge is a combination of Wheatstone bridge and vacuum-tube voltmeter.

The bridge is composed of the four arms, *A*, *B*, *N*, *P*, as shown in the diagram at the bottom of the page, with the power applied across the arms, *A*, and *B*, and the vacuum-tube voltmeter connected across the conjugate pairs, *A-N* and *B-P*. For checking the galvanometer zero, the tube is isolated from the bridge voltage in the CHECK position, with the high resistors, *N* and *P*, connected to the grid exactly as in the OPERATE position. The effects of any voltages, alternating or direct, in the unknown resistor, *P*, and of any grid current of the tube will not appear in the bridge balance because they are balanced out in the zero adjustment. There is also a CHARGE position, in which the unknown resistor, *P*, is placed across the arm, *B*. This is valuable in measuring the resistance of large capacitors because full voltage is applied directly to the capacitor which can then

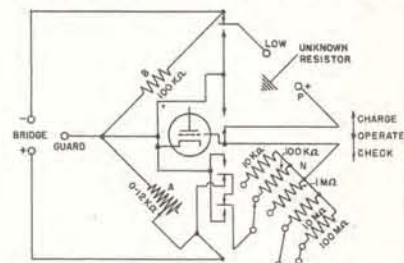

Schematic diagrams of the megohm bridge.

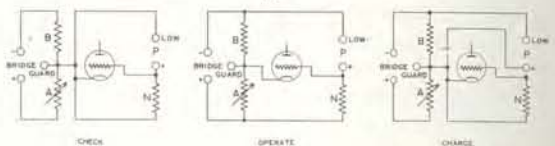



charge at a maximum rate. The zero of the galvanometer can also be checked at any time without being affected by the residual charge in the capacitor.

FEATURES:

➤ The direct measurement of resistances up to 1,000,000 megohms is made possible by the use of a vacuum-tube detector, which absorbs a negligible amount of power.

➤ Constant fractional accuracy, regardless of setting, is obtained by using a resistance scale that is approximately logarithmic over one decade. The effective scale length for the range from 100,000 ohms to 10,000 megohms is 35 inches.

➤ The voltage applied to the unknown resistance is held approximately constant, regardless of the value of the unknown resistance. This condition is necessary to measure insulation resistance properly.

➤ Voltage stabilization is used in the a-c power supply to prevent surges in charging current when the leakage resistance of capacitors is measured.



The Megohms dial of Type 544-B Megohm Bridge. The scale is approximately logarithmic over the main decade from 1 to 10.

SPECIFICATIONS

Range: 0.1 megohm to 1,000,000 megohms, covered by a dial and a 5-position multiplier switch. A resistance of 1,000,000 megohms can be distinguished from infinity.

Accuracy: $\pm 3\%$ on the 0.1, 1, and 10 multipliers; $\pm 4\%$ on the 100 and 1000 multipliers. Above 10,000 megohms, the accuracy is essentially that with which the scale on the MEGOHMS dial can be read.

Terminals: All high-voltage terminals are insulated as a protection to the operator.

Power Supply: Two types of power supply are available: (1) an a-c unit delivering d-c test voltages of 500 volts and 100 volts to the bridge, and (2) a battery power supply of 90 volts. The a-c unit operates from a 105- to 125-volt (or 210- to 250-volt), 40- to 60-cycle line. The battery power supply consists of 1 No. 6 Dry Cell and 3 45-volt batteries. This supplies 45 volts for the tube anode and 90 volts for the test voltage.

The bridge with a-c power unit will also operate satisfactorily from 400-cycle supply, although line-frequency ripple will be somewhat greater than with 60-cycle supply.

Power Input: 60 watts at 115 volts, 60 cycles; with bat-

tery supply, approximate current requirements are 60 ma for cathode heaters and 7.5 ma for anode.

External Bridge Voltage: Terminals are provided so that the bridge voltage can be obtained from an external source if desired. Up to 500 volts can be applied.

Tube Complement: With battery power supply, a 11A detector tube is used; the 500-volt power supply uses a 6K7-G detector, a 6X5-GT rectifier, a 5U4-G rectifier, and, in the voltage regulators, a 6J5-GT, a 6K6-GT, a 4A1 ballast tube, and two TYPE NE-48 neon lamps.

Accessories Supplied: Test probe. With a-c power supply, a TYPE CAP-35 Power Cord, spare fuses, and spare neon ballast tube. Batteries are supplied with the battery-operated model.

Mounting: Shielded oak cabinet with cover.

Dimensions: Cabinet with cover closed, (width) $8\frac{1}{2}$ x (length) $22\frac{1}{2}$ x (height) 8 inches, over-all.

Net Weight: With battery power supply, $29\frac{1}{2}$ pounds; with a-c power supply, $26\frac{3}{8}$ pounds; TYPE 544-P10, $14\frac{1}{4}$ pounds; TYPE 544-P3, $11\frac{1}{8}$ pounds.

Type		Code Word	Price
544-BA	Megohm Bridge, with A-C Power Supply	AGREE	\$365.00
544-BB	Megohm Bridge, Battery Operated (Incl. Batteries)	ALOOF	250.00
544-P3	A-C Power Supply Unit Only	AGREEAPACK	155.00
544-P10	Battery Power Supply Unit Only	ALOOFAPACK	40.00

OTHER INSTRUMENTS FOR HIGH RESISTANCE MEASUREMENTS: Two direct-indicating instruments for measuring resistances in the megohm range are the TYPE 1862-B Megohmmeter, described on page 132, and the TYPE 1230-A D-C Amplifier and Electrometer, described on page 130.





TYPE 716-C CAPACITANCE BRIDGE

FOR THE PRECISE MEASUREMENT OF CAPACITORS AND DIELECTRIC MATERIALS

USES: This precise, direct-reading, capacitance bridge can be used for a wide variety of capacitance and dissipation-factor measurements. Within its scope are the determination of dielectric constant, dissipation factor, loss factor, phase angle, and other dielectric properties of insulating materials, as well as their change with such factors as frequency, temperature, and humidity.

In addition to direct-reading capacitance measurements, the bridge is capable of measuring other impedances by substitution methods. Among these are the inductance and storage factor of large inductors, up to several thousand henrys; the inductance and resistance of cables at frequencies up to 300 kc; the resistance and parallel capacitance of high-valued resistors, up to several thousand megohms; and capacitances up to several thousand microfarads.

By the addition of an external decade resistor, the bridge can be converted to either a series- or a parallel-resistance bridge; the latter is especially useful in measuring the resistance of electrolytes.

In the General Radio laboratories the TYPE 716 Capacitance Bridge is used for all capacitance standardization measurements. In production it is used for the testing and adjustment of all precision fixed capacitors.

DESCRIPTION: The TYPE 716-C Capacitance Bridge is a modified Schering bridge, direct reading in capacitance at any frequency, and in dissipation factor at 100 cycles, and 1, 10, and 100 kilocycles.

A wide capacitance range at 1 kilocycle is obtained by four sets of ratio arms giving multiplying factors from 1 to 1000 in decade steps. The built-in standard is a worm-driven TYPE 722 Precision Capacitor, calibrated to read directly in total capacitance. All capacitances to ground of the input transformer and ratio arms are removed from the capacitance arms by enclosure in a shielded compartment insulated from the grounded panel and connected to the junction of the ratio arms.

Dissipation factor is indicated directly by the scale setting of an air capacitor and from a decade-step capacitor connected across the



fixed ratio arm. The 12-inch scale of the air capacitor is approximately logarithmic, so that, while having a maximum reading of 0.06, its smallest division near zero is 0.0001, thus allowing the estimation of 0.00002. The accuracy of the dissipation factor reading over the wide capacitance range is made possible by added capacitance across the lower-valued ratio arms, so that the product $RC\omega M^*$ of all the ratio arms is the same.

* Where M is the multiplier setting.

FEATURES:

- Wide capacitance and frequency ranges
- High accuracy
- Direct-reading dials
- Operation is simple, and both terminals and controls are arranged for convenience and flexibility of operation.
- Operation up to 300 kilocycles is made possible by careful design of the shielded transformer to minimize leakage impedances and dielectric losses.

SPECIFICATIONS

Ranges: Direct Reading: capacitance, 100 $\mu\mu\text{f}$ to 1.1 μf at 1 kc; 100 $\mu\mu\text{f}$ to 1150 $\mu\mu\text{f}$ at 100 c, 10 kc, and 100 kc; dissipation factor, 0.00002 to 0.56.

Substitution Method: capacitance, 0.1 $\mu\mu\text{f}$ to 1050 $\mu\mu\text{f}$ with internal standard; with external standards, to as high a capacitance as that of the available standards;

maximum dissipation factor, $0.56 \times \frac{C'}{C_x}$ where C' is the

capacitance of the standard capacitor and C_x that of the unknown.

Accuracy: Direct Reading: capacitance, $\pm 0.1\%$ $\pm (1 \mu\mu\text{f} \times \text{capacitance multiplier setting})$ when the dissipation factor of the unknown is less than 0.01; dissipation factor, ± 0.0005 or $\pm 2\%$ of dial reading, whichever is the larger, for values of D below 0.1.

Substitution Method: capacitance, $\pm 0.2\%$ or $\pm 2\mu\mu\text{f}$, whichever is the larger; dissipation factor, ± 0.00005 or $\pm 2\%$ for the change in dissipation factor observed, when the change is less than 0.06.

A correction chart for the precision capacitor is supplied, giving scale corrections to 0.1 $\mu\mu\text{f}$ at multiples of 100 $\mu\mu\text{f}$. By use of these data, substitution measurements can be made to $\pm 0.1\%$ or $\pm 0.8 \mu\mu\text{f}$, whichever is the larger. For capacitance less than 25 $\mu\mu\text{f}$, the error will decrease linearly to $\pm 0.1 \mu\mu\text{f}$. It is also possible to obtain, at an extra charge, a worm-correction calibration with which substitution measurements can be made to an accuracy of 0.1% or $\pm 0.2 \mu\mu\text{f}$, whichever is the larger.

When the dissipation factor of the unknown exceeds the limits given above, additional errors occur in both capacitance and dissipation-factor readings. Correction formulae are supplied, by means of which the accuracy given above can be maintained over all ranges of the bridge.

Zero Capacitance: (Across UNKNOWN terminals) Approximately 1 $\mu\mu\text{f}$; negligible in substitution measurements and in direct measurements with multiplier settings of 10, 100, and 1000.

Frequency Range: The accuracies given above hold for operating frequencies from 30 c to 300 kc, provided that the operating frequency does not differ from the range selector frequency by more than a factor of three. Dissipation-factor readings are obtained by multiply-

ing the dial reading by the ratio of operating frequency to the range-selector frequency.

Voltage: Voltage applied at the GENERATOR terminals is fed to the bridge through a 1-to-1 shielded transformer. A maximum of 1 watt can be applied, allowing a maximum of 200 volts at 1 kc, but only 50 volts at 60 cycles. If generator and detector are interchanged, 750 volts can be applied at frequencies of 1 kc and below.

Temperature and Humidity: Variations of temperature over normal ranges (65° F to 95° F) have no significant effect on the accuracy of the bridge, but precise measurements of dissipation factor should not be attempted when the bridge has been exposed to conditions of abnormally high relative humidity, unless it is dried by heat or a desiccant.

Mounting: The bridge is supplied either for mounting on a 19-inch relay rack or in a hardwood cabinet.

Accessories Required: Oscillator and high impedance detector. For the power source the TYPE 1302-A Oscillator (page 106) is recommended. TYPE 1231-B Amplifier and Null Detector (page 61) with TYPE 1231-P Filters (page 62), or the TYPE 1212-A Unit Null Detector with TYPE 1951-A Filter (page 63) is recommended for use as the detector at audio frequencies. At low radio frequencies a radio receiver is satisfactory for aural null indications.

For substitution measurements a balancing capacitor is needed. This may be a TYPE 722 Precision Capacitor or a fixed capacitor, TYPES 505, 1409, 1401, pages 164-169. A guard circuit for use in the measurement of direct capacitance is described on page 13. The TYPE 1610-A Capacitance-Measuring Assembly which includes generator, detector, guard circuit and other accessories, is described on page 16.

Accessories Supplied: Two TYPE 274-NL Shielded Patch Cords.

Other Accessories Available: For measurements on unguarded dielectric specimens, the TYPE 1690-A Dielectric Sample Holder (page 16) is recommended. For measurements of small capacitors having parallel side-by-side leads, the TYPE 1691-A Capacitor Test Fixture (page 13) is recommended.

Dimensions: Relay-rack model: panel, 19 x 14 inches; depth behind panel, 9 inches; cabinet model: (length) $21\frac{3}{4}$ x (height) $14\frac{3}{4}$ x (depth) $11\frac{1}{8}$ inches, overall.

Net Weight: $44\frac{1}{2}$ pounds, relay-rack model; $54\frac{1}{2}$ pounds, cabinet model.

Type		Code Word	Price
716-CR	Capacitance Bridge (Relay-Rack Model)	BONUS	\$595.00
716-CM	Capacitance Bridge (Cabinet Model)	BOSOM	620.00
	Worm-Correction Calibration for Internal Precision Capacitor.....	WORMY	50.00

TYPE 1610-A CAPACITANCE MEASURING ASSEMBLY A complete capacitance measuring assembly, including bridge, guard circuit, generator, and detector is listed on page 14.





TYPE 716-CS1 CAPACITANCE BRIDGE FOR CAPACITANCE MEASUREMENTS AT 1 MEGACYCLE

Both commercial and military specifications for capacitors of 1000 μf and less call for measurements of capacitance and dissipation factor at a frequency of one megacycle. The TYPE 716-CS1 Capacitance Bridge has been designed specifically for these measurements. This bridge, a modification of the standard TYPE 716-C model, has unity ratio arms, a single capacitance range, and a limited

frequency range. The standard capacitor is a TYPE 722-N, designed for use at 1 megacycle and above, and the input transformer is designed for high-frequency operation.

In addition to its use in testing capacitors, the TYPE 716-CS1 Capacitance Bridge is satisfactory for measuring dielectrics with the TYPE 1690-A Dielectric Sample Holder at the ASTM test frequency of one megacycle.

SPECIFICATIONS

Capacitance Range: Direct Method, 100 to 1150 μf ; Substitution Method, 0.1 to 1050 μf .

Dissipation Factor Range: Direct Method, 0.00002 to 0.56;

Substitution Method, $0.00002 \times \frac{C'}{C_x}$ to $0.56 \times \frac{C'}{C_x}$, where C' is the capacitance setting of the internal standard capacitor at initial balance and C_x is the capacitance of the unknown.

Frequency Range: Calibrated for one megacycle, the bridge operates satisfactorily at frequencies between 0.1 and 5 megacycles.

Accuracy (at one megacycle): Same as that of TYPE 716-C at 1 kc, see preceding page.

This same accuracy can be obtained at other frequencies between 0.1 Mc and 3 Mc, if corrections are made for the effects of residual impedance, and if adequate selectivity is provided for the null detector.

Accessories Required: Generator and detector. For measurement at one megacycle only, the TYPE 1214-M Unit Oscillator (page 112) is the recommended generator; for measurements over the range of 0.5 to 3 Mc, the TYPE

1211-B Unit Oscillator with Unit Power Supply (page 114); other oscillators and standard-signal generators are also satisfactory. For the detector at 1 Mc the TYPE 1212-A Unit Null Detector (page 62) with TYPE 1212-P2 One-Megacycle Filter and Unit Power Supply is recommended. For operation at frequencies other than 1 Mc, a well-shielded communications receiver should be used.

For substitution measurements, a balancing capacitor is needed. This may be a fixed TYPE 505, 1409, or 1401 Capacitor or a variable TYPE 722 Precision Capacitor (pages 164-169).

Accessories Supplied: Two TYPE 874-R34 Cables, to fit generators and detectors recommended above.

Other Accessories Available: For measurements on unguarded dielectric specimens, the TYPE 1690-A Dielectric Sample Holder (page 16) is recommended. For measurements of small capacitors having parallel side-by-side leads, the TYPE 1691-A Capacitor Test Fixture (page 13) is recommended.

Other specifications are the same as those for the standard TYPE 716-C.

Type		Code Word	Price
716-CMS1	Capacitance Bridge (Cabinet Model).....	BOGEY	\$580.00
716-CRS1	Capacitance Bridge (Relay-Rack Model)	BACON	545.00
	Worm-Correction Calibration for Internal Precision Capacitor	WORMY	50.00

TYPE 1610-AH CAPACITANCE MEASURING ASSEMBLY: A complete assembly, including bridge, generator, detector, and relay rack is listed on page 17.



TYPE 716-P4 GUARD CIRCUIT



USES: The Guard Circuit facilitates the measurement of guarded dielectric samples and of other small capacitances where a three-terminal measurement is necessary. It is particularly useful in the measurement of compo-

nents and materials over wide ranges of temperature and humidity, because it eliminates from the measurement the effects of the leads from the bridge to the sample in its conditioning apparatus and permits the same accuracy of measurement that would be obtained if the sample were positioned directly at the bridge terminals.

DESCRIPTION: See schematic. The guard arms *S* and *T* make it possible to balance any combination of capacitance and loss normally encountered in the terminal impedance of the unknown.

The circuit and switching are arranged for either direct reading or substitution methods. An 1150- μf variable balancing capacitor is built into the guard circuit for substitution measurements and can be switched in or out of circuit, as required. Thus, the only external connection required is that to the unknown itself, for either direct-reading or substitution measurements.

SPECIFICATIONS

Capacitance Range: Designed for use with the $\times 1$ multiplier ranges of the TYPE 716-C Capacitance Bridge, i.e., a range of 0-1050 μf . The range can be extended by the addition of external capacitance to the standard arm of the bridge.

Frequency Range: Corresponds to that of TYPE 716-C.

Guard Balance Capacitor: Any value of capacitance between the guard point and the high measuring terminal up to 1000 μf can be balanced out.

Accessories Supplied: One TYPE 874-Q2 Coaxial Adaptor. One TYPE 838-B Alligator Clip.

Net Weight: TYPE 716-P4R, 17 lbs.; TYPE 716-P4M, 23 lbs.

Dimensions: 19 \times 8 $\frac{3}{4}$ \times 9 $\frac{1}{8}$ inches.

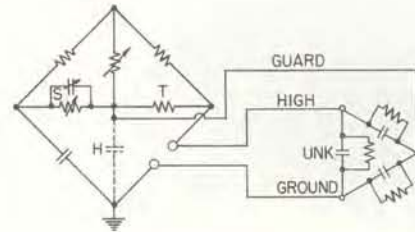

Type	Code Word	Price
716-P4M	BOSOMGUARD	\$315.00
716-P4R	BONUSGUARD	295.00

PATENT NOTICE. See Note 4, page x.

TYPE 1691-A CAPACITOR TEST FIXTURE

SIMPLIFIES AND SPEEDS UP THE TESTING OF
SMALL CAPACITORS



$$C_0 = C_1 + C_2 = (9 \pm 1) \mu\mu f$$

(Left) TYPE 1691-A Capacitor Test Fixture; (center) View showing disc-type ceramic capacitor inserted in fixture; and (right) nature and magnitude of zero capacitance, which does not enter measurement when substitution measurement is used.

USES: This fixture assures accurate and reproducible measurements of small capacitors having full length parallel leads, by providing a standard method of attachment that eliminates variable lead capacitance. It is particularly useful with the TYPE 716-CS1 Capacitance Bridge in the measurement of disc-ceramic capacitors at one megacycle.

DESCRIPTION: The fixture consists of two hollow shields, into which the test capacitor leads are fully inserted and held by spring clips, surrounded by another shield. Two banana plugs, spaced 3/4 inch on centers, allow the fixture to be plugged into the measuring instrument. Losses are negligible.

Dimensions: 1 $\frac{1}{2}$ \times 1 $\frac{1}{2}$ \times 2 $\frac{1}{2}$ inches, over-all.

Net Weight: 4 ounces

Type	Code Word	Price
1691-A	EDICT	\$22.50



TYPE 1610-A and -A2 CAPACITANCE MEASURING ASSEMBLIES



USES: The TYPE 1610-A Capacitance Measuring Assembly is a conveniently arranged unit containing complete equipment for highly precise measurement of capacitance and dissipation factor. Both two-terminal and three-terminal capacitances (two-terminal capacitances only with TYPE 1610-A2, see below) can be measured, either by direct or substitution methods, over the frequency range from 30 cycles to 100 kilocycles.

With the guard circuit, which is included with the TYPE 1610-A, accurate measurements can be made on samples some distance from the bridge, as is necessary in environmental testing.

DESCRIPTION: The TYPE 1610-A consists of:

- 1 TYPE 716-C Capacitance Bridge (see page 10)
- 1 TYPE 716-P4 Guard Circuit (see page 13)
- 1 TYPE 1302-A Oscillator (see page 106)
- 1 TYPE 1231-BRFA Amplifier and Null Detector (includes 1 TYPE 1231-P5 Filter) (see page 61).

Rack cabinet and connecting cables.

The TYPE 1610-A2 is identical except that the TYPE 716-P4 Guard Circuit is omitted and a blank panel substituted. This assembly is used for 2-terminal measurements only.

The oscillator frequency range is from 10 cycles to 100 kc. The filter in the assembly is tuned to 11 fixed frequencies as selected by a switch, and any other frequency in the range from 20 c to 100 kc with the addition of external capacitance.

FEATURES:

- Complete assembly for direct and substitution capacitance measurements, two-terminal or three-terminal for TYPE 1610-A, two-terminal for TYPE 1610-A2, from 30 c to 100 kc.
- Dielectric samples and capacitors can be measured with TYPE 1610-A while in a conditioning chamber.
- Instruments can be used separately without electrical or mechanical changes.
- The TYPE 1690-A Dielectric Sample Holder can be mounted directly on Capacitance Bridge for 2-terminal measurements.
- Entire assembly operates from power line.

SPECIFICATIONS

See specifications for TYPE 716-C Capacitance Bridge, TYPE 716-P4 Guard Circuit, TYPE 1231-BRFA Amplifier and Null Detector (includes TYPE 1231-P5 Filter), and TYPE 1302-A Oscillator.

Accessories Required: None, except a balancing capacitor for substitution measurements when the Guard Circuit is not used. This may be the TYPE 722-D Precision Capacitor, the TYPE 1409 Standard Capacitor, or the TYPE 505 Fixed Mica Capacitor (see pages 164-169)

Power Supply: 105 to 125 (or 210 to 250) volts, 50 to 60 cycles. This equipment will also operate satisfactorily on power supply frequencies up to 400 cycles; provided that the supply voltage is at least 115 volts.

Power input receptacle will accept either 2-wire (TYPE CAP-35) or 3-wire (TYPE CAP-15) power cord. Two-wire cord is supplied. For 3-wire, see page 237.

Accessories Supplied: Necessary cables, adaptor, alligator clip, and spare fuses.

Accessories Available: For measurements on unguarded dielectric specimens, the TYPE 1690-A Dielectric Sample Holder (page 16) is recommended. Worm-correction calibration for internal precision capacitor in bridge (see page 11).

Dimensions: (Height) 43 x (width) 22½ x (depth) 20 inches, over-all.

Net Weight: 202½ pounds for TYPE 1610-A, 180 pounds for TYPE 1610-A2.

Type		Code Word	Price
1610-A	Capacitance Measuring Assembly	SEDAN	\$2090.00
1610-A2	Capacitance Measuring Assembly (less Guard Circuit)	SABER	1795.00

PATENT NOTICE. See Notes 1, 2, and 4, page x.



TYPE 1610-AH CAPACITANCE MEASURING ASSEMBLY

FOR MEASUREMENTS AT 1 MEGACYCLE

USES: Both commercial and military specifications for capacitors of 1000 $\mu\mu\text{f}$ and less call for measurement of capacitance and dissipation factor at a frequency of one megacycle.

The TYPE 1610-AH Capacitance Measuring Assembly is a complete set of equipment for making these as well as other 2-terminal measurements.

Accessories are available which enhance the usefulness and convenience of the assembly for specific measurements.

For the measurement of small capacitors, particularly disc-ceramic types, the TYPE 1691-A Capacitor Test Fixture (page 13) is recommended.

With the TYPE 1690-A Dielectric Sample Holder (page 15), specimens of dielectric materials in the form of standard ASTM 2-inch (or smaller) discs can be measured.

Although calibrated for a frequency of one megacycle, the bridge can be used at any frequency between 0.1 and 5 megacycles, if a variable-frequency oscillator and a tunable selective detector are available.

DESCRIPTION: The assembly consists of:

TYPE 716-CS1 Capacitance Bridge	See page 12
TYPE 1214-M Unit Oscillator	112
TYPE 1212-A Unit Null Detector	63
TYPE 1212-P2 One-Megacycle Filter	64
TYPE 1203-B Unit Power Supply	142
TYPE 480-P4U1 and TYPE 480-P4U3 Adaptor Panels	202
Relay Rack Cabinet	
Connection Cables and Power Cord	



SPECIFICATIONS

Ranges and Accuracy: Identical with those for the TYPE 716-CS1 Capacitance Bridge, page 13.

Accessories Available: Dielectric Sample Holder, Capacitor Test Fixture, balancing capacitor, and worm-correction calibration for internal precision capacitor, in bridge as listed under TYPE 716-CS1, page 12.

Power Supply: 105 to 125 volts, 50 to 60 cycles, 100 watts input at 115 v line. Assembly will operate satisfactorily on power-supply frequencies up to 400 cycles, provided that the supply voltage is at least 115 volts.

Dimensions: (Height) 43 x (width) 22½ x (depth) 20 inches, over-all.

Net Weight: 150 pounds, approximately.

Type	Code Word	Price
1610-AH Capacitance Measuring Assembly	SIREN	\$995.00

PATENT NOTICE. See Note 4, page x.



TYPE 1690-A DIELECTRIC SAMPLE HOLDER

FOR 2-TERMINAL MEASUREMENTS



USES: The TYPE 1690-A Dielectric Sample Holder is a micrometer-driven sample holder of the Hartshorn type,* intended primarily for measurement of dielectric constant and dissipation factors of specimens of dielectric materials in the form of standard ASTM 2-inch diameter discs. It is suitable for any flat sample whose largest dimension is not greater than 2 inches and thickness not greater than 0.3 inch. It can be used, for example, with resonant circuits for susceptance-variation or frequency-variation measurements, with the TYPE 716-C and TYPE 716-CS1 Capacitance Bridges, the TYPE 874-LBA Slotted Line, and the TYPE 1602-B Admittance Meter.

DESCRIPTION: A precision micrometer screw drives the movable grounded electrode with respect to a fixed insulated electrode. The screw adjustment control is a

large instrument knob, in contrast to the small thimble employed in the usual machinist's micrometer. Attached to the knob is an accurately divided drum which indicates the spacing between electrodes. The micrometer screw is electrically shunted by a metal bellows, assuring positive low-resistance connection at all times. A release mechanism is incorporated in the design of the movable electrode, so that when full positive contact is made between the two electrodes, the drive disengages, thus protecting the mechanism against mechanical stress. When the surfaces of the specimen are not exactly parallel the movable electrode will adjust itself to the plane of the specimen surface.

A vernier capacitor with a capacitance range of $5 \mu\text{f}$ is also provided, for use in determining capacitance increments in the susceptance-variation method. This capacitor is of the cylindrical type, the movable cylinder being a precision micrometer screw. Ten turns of the screw cover the range of $5 \mu\text{f}$, and the drum attached to the screw is accurately divided into 50 divisions, each corresponding to $.01 \mu\text{f}$.

The assembly is mounted in a rugged aluminum casting, which shields it on four sides. The shielding is completed by two removable cover plates, which permit access to the electrodes. The holder can be mounted on either horizontal or vertical panels.

FEATURES:

- A dielectric specimen can be measured over a wide range of frequencies with the same holder in different measuring circuits.
- Corrections for edge fringing and stray capacitance are taken care of by the calibration.
- Rigid casting supports entire structure.
- Large easily read dials.
- Complete shielding.
- Flexibility—can be used with a number of different bridges or other measuring circuits.
- Precision calibration provided.
- "Floating" electrode protects precision drive.

*L. Hartshorn and W. H. Ward, Proceedings of the Institution of Electrical Engineers, v. 79, pp. 597-609 (1936).

SPECIFICATIONS

Electrodes: Diameter, 2.000 inches ± 0.0025 . Surfaces are ground optically flat within a few wavelengths.

Electrode Spacing: Adjustable from zero to 0.3-inch indicated by the micrometer reading in mils.

Vernier: Incremental capacitance is $5 \mu\text{f}$, nominal.

Calibration: For the main capacitor, a chart is provided giving the calculated air capacitance as a function of spacing. A correction curve is also provided with each holder, giving the measured deviations from calculated values over the range from 300 mils to 10 mils spacing. In accordance with recommended ASTM practice, this calibration is referred to the calculated geometric value at a spacing of 100 mils. Accuracy is $\pm 0.2\% \pm 0.1$ mil.

For the vernier capacitor, a correction chart is provided, from which capacitance differences can be determined to an accuracy of $\pm 0.004 \mu\text{f}$.

Zero Capacitance: Approximately $11 \mu\text{f}$.

Frequency: No significant error occurs at frequencies below 100 Mc. At higher frequencies satisfactory results can be obtained for many types of measurements.

Accessories Supplied: TYPE 1690-P1 Adaptor Assembly for mounting to the TYPES 716-C, and -CS1 Capacitance Bridges. Hardware is supplied for mounting sample holder on TYPES 740-B, 1611-A, 1604-B, 544-B Bridges and TYPE 1862-B Megohm-meter.

Accessories Available: TYPE 1690-P2 Adaptor Assembly for connecting to TYPE 874-LBA Slotted Line or TYPE 1602 Admittance Meter.

Mounting: Supplied with a wooden carrying case. A drawer in the case provides storage for hardware, and a spring clip holds the calibration charts.

Dimensions: Over-all, mounted on adaptor, $6\frac{1}{4} \times 5\frac{3}{4} \times 4\frac{1}{2}$ inches.

Net Weight: $3\frac{3}{4}$ pounds.

Type		Code Word	Price
1690-A	Dielectric Sample Holder	LOYAL	\$435.00
1690-P2	Adaptor Assembly	LOYALMOUNT	20.00

(for connection to coaxial equipment)

PATENT NOTICE. See Note 4, page x.



TYPE 740-B CAPACITANCE TEST BRIDGE

**RELIABLE, MODERATELY
PRICED BRIDGE
FOR SHOP AND
LABORATORY**



USES: The TYPE 740-B Capacitance Test Bridge is a 60-cycle capacitance and dissipation-factor bridge for use in both laboratory and production testing of paper, mica, and polarized electrolytic capacitors. The capacitor manufacturer can use it for production tests, the capacitor user for acceptance tests. It is particularly useful in testing polarized electrolytic capacitors, because the test conditions approximate the normal operating conditions of use.

DESCRIPTION: The circuit used in this instrument is that of a series-resistance capacitance bridge. One ratio arm is variable in decade steps, and the other is continuously variable and calibrated directly in capacitance.

The TYPE 740-B Capacitance Test Bridge is a simpler instrument than the TYPE 1611-B, with a smaller capacitance range and lacking some of the features of the latter instrument.

FEATURES:

- Measures the direct capacitance of *un-grounded* capacitors.
- Visual null indicator makes the bridge useful for production testing in noisy locations.
- Simple to operate.
- Normal operating conditions for polarized electrolytic capacitors are reproduced by the use of a d-c polarizing voltage. The a-c voltage impressed by the bridge itself is small and simulates the ripple usually encountered in power-supply filters.

SPECIFICATIONS

Capacitance Range: $5\mu\text{f}$ to $1100\mu\text{f}$ in seven ranges. Capacitance values are read directly from a logarithmic dial and multiplier switch.

Capacitance Accuracy: Within $\pm 1\%$ over the main decade (1 to 11) of the CAPACITANCE dial for all multiplier settings except .0001. Within $\pm 1.5\%$ or $\pm 3\mu\text{f}$, whichever is the larger, on the .0001 multiplier on the main decade of the CAPACITANCE dial. Below $100\mu\text{f}$ the error gradually increases to $\pm 5\mu\text{f}$ as zero is approached.

Dissipation Factor Range: 0 to 50% in two ranges. Scale has 50 divisions.

Dissipation Factor Accuracy: Within $\pm 1.5\%$ of fullscale reading for all capacitance multipliers except .0001.

On the .0001 capacitance multiplier a correction of 0.3% should be subtracted from the dissipation-factor dial reading. When this correction is made the accuracy is within ± 2 dial divisions on the x1 multiplier and within ± 1 division on the x10 multiplier.

Voltage Applied to Unknown: The voltage impressed across

the unknown terminals varies continuously with the bridge setting. For very small capacitances in the lowest range, this voltage is approximately 35 volts, and it decreases with increasing capacitance, so that at $100\mu\text{f}$ it is approximately one volt.

Polarizing Voltage: Terminals for connecting a d-c polarizing voltage are provided on the panel.

Power Supply: 105 to 125 (or 210 to 250) volts, 60 cycles. The power input is 15 watts.

Controls: Capacitance dial and multiplier, dissipation-factor control and multiplier, sensitivity control.

Accessories Supplied: TYPE CAP-35 Power Cord and spare fuses.

Tube Complement: One each 6X5GT/G, 6J7, 6E5.

Mounting: Portable carrying case, of airplane-luggage construction.

Dimensions: (Length) $14\frac{1}{2}$ x (width) 15 x (height) $9\frac{1}{4}$ inches, over-all, including cover and handles.

Net Weight: 19 pounds.

Type	Code Word	Price
740-B Capacitance Test Bridge.....	BABEL	\$285.00



TYPE 1611-B CAPACITANCE TEST BRIDGE

FOR SHOP, FIELD, OR LABORATORY



USES: Capacitance and dissipation-factor measurements at 60 cycles and 120 cycles can be made quickly and conveniently with this bridge. Among its uses are:

- Laboratory and shop testing of paper and mica capacitors.
- Measurements of polarized electrolytic capacitors at 120 cycles (or 60 cycles).
- Measurement of dielectric properties of solid insulation and transformer oil.
- In the electric power industry, for the shop testing of insulators and insulation, including bushings, transformers, rotating machines, and cable. Results are unaffected by adjacent bus potentials of several thousand volts.
- For the wire and cable manufacturer, this bridge offers a convenient and rapid means for locating breaks in cable and for laboratory and production tests of dissipation factor and capacitance on all kinds of cable.
- The electronics industry will find it useful, not only for routine capacitance and dissipation-factor tests on component capacitors,

but also for checking capacitance to ground of transformer windings, shields, and circuit elements.

DESCRIPTION: The circuit used is the series-resistance capacitance bridge. One ratio arm is continuously variable and calibrated to read directly in capacitance. The other ratio arm is variable in decade steps and serves as a multiplier for the direct-reading dial. The variable resistors in series with the standard capacitors are calibrated directly in dissipation factor.

A shield terminal is provided, to which a guard electrode or a ground terminal can be connected for 3-terminal measurements.

A visual null indicator is used, consisting of a tuned amplifier and an electron-ray tube. The entire instrument is a-c operated.

For 60-cycle measurements, bridge power is derived directly from the power line. For 120-cycle measurements, an external oscillator, TYPE 1214-D is used. Other frequencies up to 1000 cps can also be used, if the detector filter is tuned externally.

A portable luggage-type carrying case houses the complete instrument.

FEATURES:

- Will measure any capacitor up to 11,000 microfarads.
- Visual null indicator is an advantage in noisy locations.
- Detector sensitivity increases as balance point is approached, which greatly simplifies process of locating balance.
- Use of low test voltage results in considerable saving in cost over equipment operating at several kilovolts.
- Moderate external electrostatic fields do not affect results, since connection to generator can be reversed and the observed results averaged.
- A d-c polarizing voltage can be introduced from an external d-c source.
- Measures polarized electrolytic capacitors under conditions of actual use—with 120-cycle ripple voltage applied.
- Measures either 2-terminal or 3-terminal capacitors.



SPECIFICATIONS

Capacitance Range: 0 to 11,000 μf at 60 cycles. 1 μf to 11,000 μf at 120 cycles or other external frequency.

Dissipation-Factor Range: 0 to 60% at 60 cycles. Range proportional to frequency. (0 to 120% at 120 cycles.)

Dial readings must be multiplied by the ratio f/60 for frequencies other than 60 cycles.

Accuracy: Capacitance, ±1%. Dissipation factor, ±(2% of dial reading +0.05% x f/60 dissipation factor).

Sensitivity: The sensitivity is such that any capacitance in the range 100 μmf to 10,000 μf can be balanced to a precision of at least 0.1%.

Detector Filter: Tuned to 60 or 120 cycles, selected by switch. Jack provided for use of an external filter for other frequencies.

External Generator: Required for frequencies other than 60 cycles. TYPE 1214-D Unit Oscillator listed below is recommended for 120-cycle measurements.

External Fields: For bushing testing, the fields usually encountered in shop and laboratory, even up to several thousand volts, will not affect the accuracy. For measurements in locations where the overhead voltages are very high, the unknown should be shielded.

A-C Voltage Applied to Capacitance under Test: The voltage impressed on the unknown capacitance varies from a maximum of approximately 125 volts at 100 μmf to less than 1 volt at 10,000 μf. The circuit is so arranged that a maximum of one volt-ampere of reactive power is de-

livered to the sample.

Polarizing Voltage: Terminals are provided for connecting an external d-c polarizing voltage. The maximum voltage that should be impressed is 500 volts.

One of the terminals is grounded so that any a-c operated power supply with grounded output can be used. The terminal capacitances of the power supply do not affect the bridge circuit.

Temperature and Humidity Effects: The readings of the bridge are unaffected by temperature and humidity variations over the range of room conditions normally encountered (65° F to 95° F, 0 to 90% RH).

Power Supply Voltage: 105 to 125 (or 210 to 250) volts, 60 cycles. A 50-cycle model is available; see price table, below. Power receptacle will accept either 2-wire (TYPE CAP-35) or 3-wire (TYPE CAP-15) power cord. Two-wire cord is supplied; for 3-wire, see page 237.

Power Input: 15 watts.

Accessories Supplied: TYPE CAP-35 Power Cord and spare fuses.

Other Accessories Required: 120-cycle oscillator, if 120-cycle measurements are to be made. TYPE 1214-D Unit Oscillator is recommended.

Mounting: Portable carrying case of luggage-type construction. Case is completely shielded to insure freedom from electrostatic pickup.

Tube Complement: One each 6X5-GT/G, 6SJ7, and 6U5.

Net Weight: 30½ pounds.

Dimensions: (Width) 14½ x (depth) 16 x (height) 10 inches, over-all, including cover and handles.

Type		Code Word	Price
1611-B	Capacitance Test Bridge.....	FAVOR	\$570.00
1611-BQ1	Capacitance Test Bridge, for 50-cycle supply.....	FAVORPASHA	645.00

TYPE 1214-D 120-CYCLE OSCILLATOR



This oscillator is intended to drive the TYPE 1611-B Capacitance Bridge at 120 cycles. It is very similar to the TYPE 1214-A Unit Oscil-

lator (page 112) except for frequency and output circuit. The output control is a four-position switch to provide four different output impedances, to match the TYPE 1611-B Bridge at each of its four 120-cycle multiplier settings, and is marked in terms of bridge multipliers.

A jack is provided for plugging in an external oscillator so that the output transformer and switching can be used at frequencies other than 120 cycles.

SPECIFICATIONS

Frequency: 120 cycles ±2%.

Output: At least 200 milliwatts into matched load.

Controls: Output impedance switch and power switch.

For complete specifications, see page 112.

Type		Code Word	Price
1214-D	120-cycle oscillator (including power supply).....	ABBOT	\$100.00

PATENT NOTICE. See Note 2, page x.





TYPE 1613-A CAPACITANCE BRIDGE

(TEST SET, CAPACITANCE BRIDGE, TTU 24/E,
PRECISION, THREE TERMINAL, DEPOT)

USES: This bridge is a calibrator for the capacitive fuel-gage testers¹ that check the accuracy of aircraft fuel-quantity gages. It meets the essential requirements of specification MIL-T-4778 (USAF) and has been given the militarily assigned commercial-standard designation TTU 24/E, as listed above. It is also an excellent, general-purpose capacitance bridge for precise, three-terminal measurements of capacitance at 400 cycles per second.

DESCRIPTION: The circuit is that of a transformer bridge, with an ingenious method for making the dissipation factor dial direct-reading. The inductively coupled ratio arms are in the detector circuit, so that the voltage on the unknown capacitor remains constant as the bridge ratio is changed. The direct impedance of the T network used in the standard side of the bridge balances the direct impedance of the unknown. The balance equations are:

$$C_X = C_A (M)$$

$$\text{and } D_X = \omega R (C_A + C_B)$$

where M is a multiplier of 1 or $\frac{1}{10}$ (as selected) and C_X is the series capacitance of the unknown.

The sum ($C_A + C_B$) is kept constant, so that R is proportional to D_X and, therefore, is directly calibrated in dissipation factor. Other transformer-type capacitance bridges require a computation to obtain this quantity.

The standard capacitor, which forms the differential unit consisting of C_A and C_B , is actually a 50-to-1100 $\mu\mu\text{f}$ variable air unit and a 1000-to-10,000 $\mu\mu\text{f}$ decade of silvered-mica capacitors. The sum ($C_A + C_B$) is kept constant by the addition of an extra set of stator plates to a TYPE 722 Capacitor, and by differential switching of the mica units. On the $\times \frac{1}{10}$ range the lower limit is extended down by a factor of $\frac{1}{10}$, so that the over-all range becomes 5 $\mu\mu\text{f}$ to 11,000 $\mu\mu\text{f}$.

The 400-cycle oscillator is thermistor stabilized and uses a Wien bridge selective R - C network in a three-stage feedback circuit,

¹General Radio TYPE 1429-A, page 174, is this type of device.

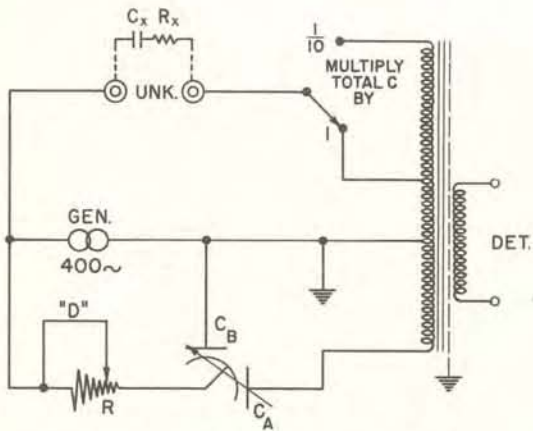

which has such a high loop gain that the frequency is practically independent of tube parameter changes. The frequency-determining components are GR precision resistors and capacitors. A buffer cathode-follower ampli-

Schematic diagram of TYPE 1613-A Capacitance Bridge.

fier is added to prevent external loading from affecting the frequency.

FEATURES:

➤ The detector circuit has several features that facilitate rapid and accurate balances. Two cascaded, selective, twin-T, feedback amplifiers provide high selectivity, and the sensitivity is more than adequate for a precise balance. The null indicator has a compressed response and uses a ruggedized meter. Two panel lights indicate the direction of capacitive unbalance when the meter is upscale. Thus it is not necessary to use a trial-and-error method of deciding which way to vary the standard capacitor when the unknown is first connected. This feature greatly reduces the time required to balance the bridge and usually makes gain-control adjustments unnecessary.

SPECIFICATIONS

Range: Capacitance, 5 μf to 11,000 μf ; dissipation factor, 0 to 0.11.

Accuracy: Capacitance, $\pm 0.1\%$ from 11,000 to 40 μf , rising to 0.8% at 5 μf ; dissipation factor, $\pm 2\%$ of reading ≈ 0.0002 .

Oscillator: Frequency, 400 cps $\pm 0.25\%$; output, 25 volts nominal.

Detector Sensitivity: $\times 1$ MULTIPLIER position—10% deflection for .05 μf ΔC .

$\times \frac{1}{10}$ MULTIPLIER position—10% deflection for .005 μf ΔC .

Detector Selectivity: Down 44 db at 800 cps, down 72 db at 60 cps.

Effect of Impedance to Third Terminal (Chassis): Impedance from the unshielded lead to chassis shunts the oscillator and, therefore, causes no bridge error. The output voltage is reduced approximately 50% by shunt impedance of 5 k Ω or 0.1 μf .

Impedance from the coaxial lead to chassis shunts the bridge transformer. On the $\times 1$ MULTIPLIER position, there is negligible effect from a shunt of 1 k Ω or 0.1 μf . On the $\times \frac{1}{10}$ MULTIPLIER position, there is negligible effect from 10 k Ω or 0.01 μf .

Accessories Supplied: For connection to TYPE 1429-A Fuel Gage Tester, two unshielded cable assemblies and one common shielded assembly; for connection to TYPE 03 Fuel Gage Tester, one cable harness, including termination unit assembly; general-purpose three-terminal measurements, one coaxial and one unshielded cable assembly, with TYPE 874 connectors. Power cord is also supplied.

Tube Complement: 5-5751; 1-12AT7WA; 1-6X4WA.

Power Supply: 105 to 125 volts, 50-60 cycles. 30 watts input at 115-volt line.

Dimensions: (Length) 22½ in. x (height) 14 in. x (depth) 12¾ inches over-all, including cover.

Net Weight: 55 lbs.



View of TYPE 1613-A Capacitance Bridge showing cabinet with cover in place.

Type	Code Word	Price
1613-A Capacitance Bridge	SUPER	\$2175.00

TYPE 1632-A INDUCTANCE BRIDGE

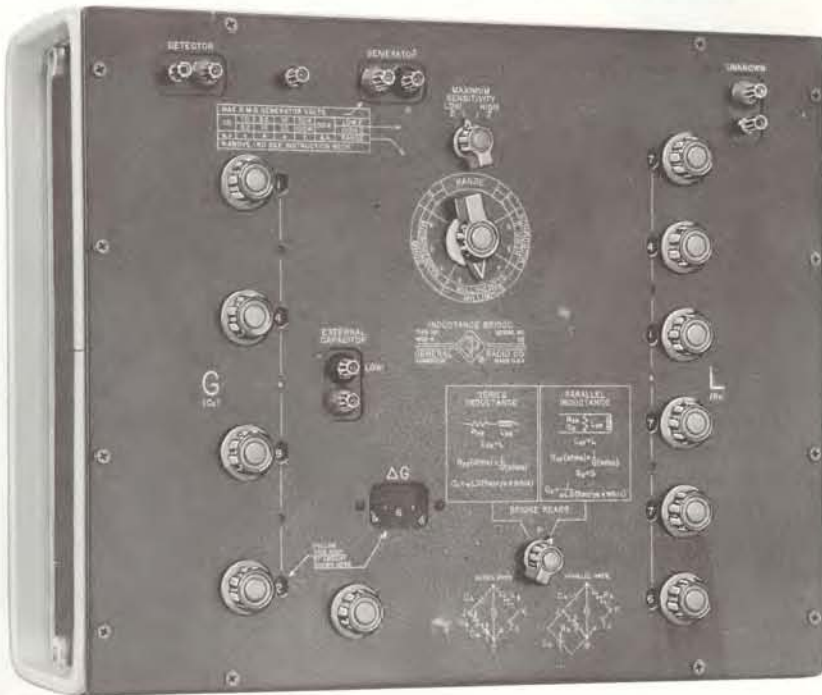

USES: The TYPE 1632-A Inductance Bridge is designed for the precise measurement of either the series or the parallel components of two-terminal grounded inductors, at audio frequencies, over a wide range of inductance from the millimicrohenry range to 1111 henrys. Its high accuracy makes it suitable for standardization measurements, while its convenient in-line read-out feature and the absence of a sliding balance make possible rapid measurements of high precision.

Measurement of incremental inductance can be made at low levels of ac and dc excitation. **DESCRIPTION:** The Owen circuit used in this bridge is shown schematically in the accompanying diagram. In this circuit, the standard reactor is a capacitor, which, owing to its very low residual impedances, exhibits a negligible change in its effective capacitance over the audio range. The Owen circuit also makes possible the use of the high accuracy of decade resistors for the inductance balance.

Inductance is indicated by the setting of a six-decade control; conductance by the setting of four decades and a variable air capacitor. The inductance dials, which show only the pertinent digit of each decade, indicate directly either series or parallel inductance. Resistance, either series or parallel, is the reciprocal of the

conductance setting. An eight-position multiplier automatically indicates both the decimal point and the units for both inductance and conductance.

Residual impedances associated with the "unknown" terminals have been minimized, with a consequent maximum of accuracy for the measurement of both large and small values of inductance.

FEATURES:

- Extremely wide range of inductance.
- Easy, fool-proof readout. Range switch locates decimal point and identifies units of measurement.

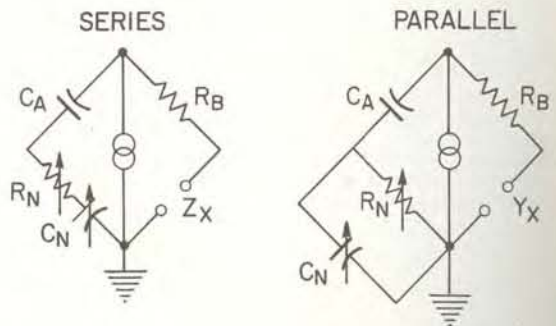



- In-line decade readings, with only the desired digits shown.
- High resolution—six significant figures.
- Measures parallel inductance for high- Q

- inductors—series inductance when Q is low.
- Will detect one millimicrohenry.
- Necessary instructions and circuit information are engraved on the panel.

SPECIFICATIONS

Range: Range selection is by an eight-position switch, which indicates units and range, and locates the decimal point in the in-line balancing decades.

Full scale ranges from 1111 μh to 1111 henries for inductance; from 1111 micromhos to 1111 mhos for conductance.

Minimum inductance indication is 0.001 microhenry, which makes balances to a precision of 0.1% possible for an inductance as low as 1 microhenry.

Inductance Balance: Six, precision, decade resistors are used for the inductance balance. Maximum resistance is 100,000 ohms, in 0.1 ohm steps.

Conductance Balance: Four decades of low-loss polystyrene capacitor plus one variable air capacitor. Maximum capacitance is 1.111 μf, minimum capacitance is 200 μμf.

Sensitivity Switch: An additional control is provided which changes the value of R_B by a factor of 10 without altering the range.

Frequency: Designed primarily for precise and accurate measurements at 1 kc and lower. Usable to at least 10 kc with some decrease in accuracy, see below.

Inductance Accuracy: Basic direct-reading inductance accuracy is ±0.1%.

Because of the extremely wide range of the bridge arms, the full accuracy cannot be realized at the extreme of inductance, Q, or frequency.

For low values of Q, an additional error of ±.05%/Q_x can occur at any frequency.

The R_B arm is switched in decade steps from 1 ohm to 100,000 ohms. The phase angles (expressed as Q_B) of these resistors are compensated to within the values given in the table.

R _B	1 Ω	10 Ω	100 Ω	1 kΩ	10 kΩ	100 kΩ
Q _B at 1 kc	±.03%	±.005%	±.002%	±.002%	±.02%	±0.1%

For frequencies above 1 kc the additional error in inductance indication is:

$$\Delta L = \pm Q_B \frac{f_{kc}}{Q_x} \%$$

Type	Code Word	Price
1632-A Inductance Bridge.....	BARGE	\$875.00

TYPE 667-A INDUCTANCE BRIDGE

The TYPE 667-A Inductance Bridge, widely used for the measurement of rf inductors at a frequency of 1 kc, is still available. It can also be used as a general-purpose inductance bridge for the measurement of self and mutual inductance. The range of inductance measurement is 0.1 μh to 1 henry, with an accuracy of ±0.2% + 0.1 μh.

The internal standard is a stable one-millihenry inductor, wound on a ceramic form. External standards can also be used.



Type	Code Word	Price
667-A Inductance Bridge.....	AERIE	\$510.00



TYPE 1650-A IMPEDANCE BRIDGE

Completely Self-Contained Universal
Bridge With Transistor Generator and
Detector

USES: The TYPE 1650 Impedance Bridge will measure the inductance and storage factor, Q , of inductors*, the capacitance and dissipation factor, D , of capacitors, and the ac and dc resistance of all types of resistors.

In the laboratory it is extremely useful for measuring the circuit constants in experimental equipment, testing preliminary samples, and identifying unlabeled parts. In the shop and on the test bench it has many applications for routine testing and component sorting.

The TYPE 1650, a completely new bridge replacing the famous TYPE 650, has many important new features and sets a new mark in convenience and general utility.

DESCRIPTION: This bridge is a completely self-contained and portable instrument. Five separate bridge circuits are included to give flexibility and wide range. Battery-powered, low-drain transistor oscillator and detector are included. The panel meter indicates both dc and ac bridge unbalances, and therefore, headphones are not required.

The measured quantities, R , L , C , D , and Q , are indicated directly on dials with logarithmic scales. No multiplier is necessary for the D and Q indications and the C , R , or L multiplier and the unit of measurement are indicated by the range switch setting.

* Including such low- Q inductors as rf coils measured at 1 kc.

The bridge circuits are made up of high quality, stable components to give accuracy for many years under a wide range of conditions. *Orthonull*, an exclusive, new, and unique mechanical-ganging device is used to make low- Q balances possible without a "sliding null". This mechanism, which may be switched in or out as desired, adds accuracy as well as convenience and makes easy many low- Q measurements that are practically impossible on other impedance bridges.

A unique cabinet design provides a handle and a captive, protective cover and allows the bridge panel to be tilted and held firmly at any desired angle.

FEATURES:

- Completely self-contained and portable.
- Wide impedance range, covering all common components.
- *Orthonull* to facilitate low- Q balances.
- Meter indication of ac as well as dc unbalances so that headphones are not necessary.
- Transistor oscillator and detector powered by common "D" cells.
- Provision for applying dc to inductors and capacitors being measured.
- Easy-to-read dials.
- Excellent D and Q accuracy.
- Very small residual errors.
- Long battery life; easy replacement.



SPECIFICATIONS

Ranges:
 Resistance, 1 mΩ to 10 MΩ, 8 ranges ac or dc
 Capacitance, 1 μf to 1000 μf, 7 ranges Series or Parallel
 Inductance, 1 μh to 1000 h, 7 ranges Series or Parallel
D (of series capacitance), 0.001 to 1 at 1 kc
D (of parallel capacitance), 0.1 to 50 at 1 kc
 ($C_s = C_p$ within 1% if $D < 0.1$)
Q (of series inductance), 0.02 to 10 at 1 kc
Q (of parallel inductance), 1 to 1000 at 1 kc
 ($L_s = L_p$ within 1% if $Q > 10$)

Accuracy:
 Resistance*, ±1% ±1 mΩ (Residual $R \approx 1\text{m}\Omega$)
 Capacitance, ±1% ±1 μf (Residual $C \approx 0.5\mu\text{f}$)
 Inductance, ±1% ±1 μh (Residual $L < 0.2\mu\text{h}$)
D, ±5% ±.001 at 1 kc or lower
 1/*Q*, ±5% ±.001 at 1 kc or lower
Frequency Range: (1 kc supplied internally)
 1% accuracy for *L* and *C*, 20 c to 20 kc;

for *R*, 10 c to 50 kc.
 (*D* and *Q* ranges are functions of frequency.)
Internal Oscillator Frequency†: 1 kc ±2%
Internal Detector: Response, flat or selective at 1 kc; sensitivity control provided.
Internal DC Supply: 6 v, 60 ma max.
Power Supply: 4 "D" cells, supplied. Current drain (ac measurements) 10 ma.
DC Polarization: 600 volts may be applied (from external source) for series capacitance measurements.
Accessories Supplied: One TYPE 274-MB Double Plug.
Other Accessories Available: TYPE 1650-P1 Test Jig.
Other Accessories Required: None. Earphones may be used where high precision is required at the extremes of the bridge ranges.
Mounting: Aluminum cabinet, with captive cover.
Dimensions: 7¾ × 12¾ × 12½ including handle.
Weight: 17 pounds.

Type	Code Word	Price
1650-A Impedance Bridge	BATON	\$440.00

PATENT NOTICE. See notes 1 and 19, page x.
 * External DC Supply required for 1% accuracy above 100 kΩ.
 † External ac and dc sources can also be used.



(Left) Bridge holds firmly in tilted position at any angle, or in vertical position.
 (Right) Completely enclosed cabinet protects bridge when not in use, or when carried.

TYPE 1650-P1 TEST JIG

This test-jig adaptor provides a way to connect components quickly to a pair of terminals, which can be placed on the bench directly in front of the operator. Thus, the test jig and 1650-A Bridge make a rapid and efficient component sorting device when the panel meter of the 1650-A is used as a limit indicator.
 The test jig makes a three-terminal connection to the bridge, so that the residual zero capacitance is negligible. The lead resistance (0.08 ohm total) has effect only when very low impedances are measured, and the lead capacitance effects only the measurement of the *Q* of inductors, introducing a small error in *D* (or 1/*Q*) of less than 0.007.

Test jig makes 3-terminal connection to the Type 1650-A Impedance Bridge. It can be placed directly in front of operator for efficient and rapid connection and measurement of components.



Type	Code Word	Price
1650-P1 Test Jig	LOCAL	\$19.00



TYPE 1605-A IMPEDANCE COMPARATOR

ACCURATE AND VERSATILE ON THE PRODUCTION LINE AND IN THE LABORATORY

USES: Typical uses for this highly precise instrument include:

- Rapid testing, sorting, and matching of precision components, etched boards, sub-assemblies and complex networks, either manually or in combination with automatic sorting equipment.
- Measuring the effects of time, temperature, humidity, and pressure on components, with high precision and continuous indication.
- Rapid test for tracking of ganged potentiometers and variable capacitors.
- Frequency characteristics of components.
- Easy comparison of quantities usually requiring laboratory techniques, such as:

Impedance difference to 0.01%

D of low-loss dielectric materials

D of Inductors

Q or phase angle of wire-wound resistors or potentiometers.

Balance of transformer windings

DESCRIPTION: This completely self-contained impedance comparator indicates directly on two panel meters the difference in impedance and phase angle between a pair of elements connected to its terminals. Three highly desirable characteristics not usually obtained together are combined in this unique instrument:

- high accuracy
- high speed
- wide ranges of impedance and frequency

As a result, not only does it bring laboratory accuracy to production-line inspection, but, conversely, it brings the speed of the production test to measurements in the laboratory.

The basic circuit of the comparator is a bridge circuit, with the unknown and standard impedances serving as two of the bridge arms and the halves of a center-tapped transformer secondary winding serving as the other two arms. An internal RC oscillator driving the transformer primary winding provides frequencies at 100 c, 1 kc, 10 kc, and 100 kc. The bridge unbalance voltage, resulting from inequality of standard and unknown impedances, is separated into in-phase and out-of-

Block schematic of the TYPE 1605-A Impedance Comparator.

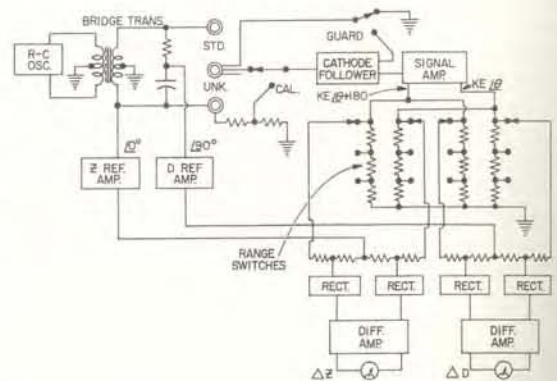



phase components, which are amplified and indicated directly by two meters reading, respectively, impedance magnitude difference in per cent and phase-angle difference in radians.

The transformer is especially designed to have as high a degree of coupling as possible between the two halves of its secondary winding. The coefficient of coupling achieved is greater than 0.9997, and the open-circuit voltages of the two halves are balanced to within 1 part in 10^6 . This makes possible measurement of differences as low as 0.01% and minimizes the loading effect of external impedances on the bridge transformer.

An unusual type of cathode-follower circuit provides a very high input impedance for the bridge detector and also a guard terminal. This shield makes possible the measurement of high impedances at a distance from the instrument, as in an environmental test chamber.

SPECIFICATIONS

Impedance Ranges: Resistance or impedance magnitude: $2\ \Omega$ to $20\ \text{M}\Omega$. Capacitance: $40\ \mu\text{f}$ to $500\ \mu\text{f}$; to $0.1\ \mu\text{f}$ with reduced sensitivity. Inductance: $20\ \mu\text{h}$ to $10,000\ \text{h}$.
Internal Oscillator Frequencies: 100 c, 1 kc, 10 kc, 100 kc; all $\pm 3\%$.

Meter Ranges: Impedance Magnitude Difference: $\pm 0.3\%$, $\pm 1\%$, $\pm 3\%$, $\pm 10\%$ full scale. (Can be adjusted for maximum of 50%) Phase Angle Difference: ± 0.003 ,

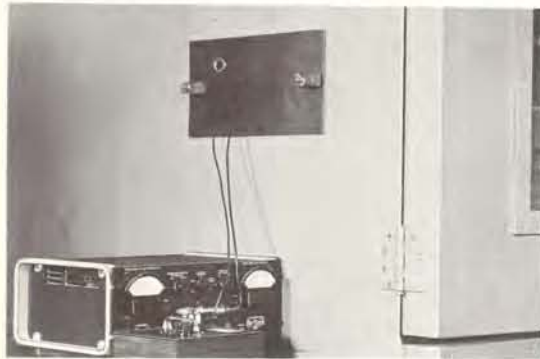

The built-in guard circuit permits the use of long leads from Comparator to sample inside conditioning chamber, as shown above.

For operating external selector circuits, meter voltages are available at the rear of the instrument; a plug connector is supplied.

Calibration can quickly be checked at any time by means of a simple built-in network.

FEATURES:

- High-speed meter indication: No balancing operation required.
- Wide frequency range: 100 cycles to 100 kc.
- High accuracy: measurements to 0.01%
- Versatile: compares impedances of any phase angle.
- Wide impedance range: $2\ \text{ohms}$ to $20\ \text{meg-ohms}$
- Compares both magnitude and phase angle simultaneously
- Guard point available
- Completely self contained
- Meter terminals are brought out at rear for operation of automatic selection devices or recorder

± 0.01 , ± 0.03 , ± 0.1 radian full scale; (equal to dissipation factor on lowest ranges).

Accuracy of Difference Readings: 3% of full scale; i.e., for the $\pm 0.3\%$ impedance-difference scale, accuracy is 0.009% of the impedance magnitude being measured.

Voltage Across Standard and Unknown: approx. 0.3 volts
Accessories Supplied: TYPE CAP-35 Power Cord, telephone plug, external-meter plug, adaptor plate assembly (fits panel terminals) and spare fuses.

Tube Complement:

1-5651	5-12AT7
1-5751	3-6U8
3-12AX7	1-6AS7G
4-6AL5	1-3A10
1-VE65A1	

Power Supply: 105 to 125 (or 210 to 250) volts, 50 to 60 cycles; about 100 watts input at 115 volts. Instrument will operate satisfactorily on power-supply frequencies up to 400 cycles, provided that the supply voltage is at least 115 volts.

Power input receptacle will accept either 2-wire (TYPE CAP-35) or 3-wire (TYPE CAP-15) power cord. Two-wire cord is supplied. For 3-wire, see page 237.

Mounting: Relay-rack panel with cabinet; TYPE 1605-AR has fittings to permit either instrument or cabinet to be removed from rack without disturbing the other; TYPE 1605-AM has end supports for table or bench use.

Dimensions: Panel $19\ \times\ 8\frac{3}{4}$ inches; depth behind panel, 12 inches.

Net Weight: $29\frac{1}{2}$ pounds.

Type		Code Word	Price
1605-AR	Impedance Comparator (relay-rack mounting)	GUNNY	\$790.00
1605-AM	Impedance Comparator (bench mounting)	GIPSY	790.00

PATENT NOTICE. See Note 4, page x.

For a complete discussion of this instrument and its circuit see *General Radio Experimenter* for April, 1956.

Models with ranges of 0.1% or less are available on special order.





TYPE 1603-A

Z-Y BRIDGE

A UNIVERSAL
AUDIO-FREQUENCY
IMPEDANCE MEASURING
INSTRUMENT

USES: This remarkable bridge can easily be balanced for any impedance connected to its terminals—from short circuit to open circuit, real or imaginary, positive or negative. Thus it can make not only the usual routine measurements but can also solve many difficult problems beyond the capabilities of other measuring instruments. Clearly, such versatility belongs in any laboratory where electrical impedance measurements are made. A few of this instrument's manifold applications are:

- Checking or identifying R , L , and C components, or any arbitrary combinations of them.
- Reactance-resistance curves for electro-acoustic transducers, such as loudspeakers, microphones, magnetic recorder heads.
- Open- and short-circuit measurements on transformers to determine leakage reactance, self and mutual inductance, and coefficient of coupling.
- Frequency characteristics of electrolytic capacitors.
- Measuring resonances of inductors and transformers.
- Complex input, output, and characteristic impedances of filters and other transmission networks.
- Transistor input and output impedance.
- Conductivity of liquids.
- In electro-chemical research, data for circular arc plots of solids or liquids having lossy polarizations.
- Negative resistance of active circuits, such as feedback loops.

DESCRIPTION: The TYPE 1603-A Z-Y Bridge measures directly the quadrature components of a complex impedance $Z = R + jX$, or a complex admittance $Y = G + jB$. Low impedances are measured in terms of series R and X , while high impedances, i.e., low admittances, are measured in terms of parallel G and B . With overlapping R and X ranges from 0 to ± 1050 ohms and

G and B ranges from 0 to ± 1050 micromhos, any value of unknown can be balanced as either an impedance or an admittance.*

The basic circuit is the familiar resistance-capacitance bridge, but a substitution technique is employed whereby an initial balance, without the unknown element, is followed by a final balance with the unknown in the circuit. The difference in setting of the controls between these two balances measures the complex components of the unknown.

In the simplified circuit shown, the series rheostats provide the R balance for impedance and the B balance for admittance, while the parallel rheostats provide the G balance for admittance and the X balance for impedance. R and G readings are independent of frequency, while X and B readings are direct at any of three reference frequencies—100 c, 1 kc, and 10 kc as selected by a switch that changes certain bridge components. At frequencies other than these three, X and B readings must be, respectively, divided and multiplied by the ratio

$$\frac{(\text{operating frequency})}{(\text{reference frequency})} = \frac{f}{f_0}$$

The details of the controls and switching have been worked out to provide the utmost in convenience of operation. The unknown element is always connected to a single pair of terminals, and a main selector switch connects it internally for either impedance or admittance measurement and disconnects it during the initial balance. The final balance controls need not be set to zero for initial balance, because the main selector switch inserts fixed resistors in their place equal to the value

* For a more detailed description consult *General Radio Experiments* for July, 1955. A reprint is available.



they would have when set to read zero. This is a convenient feature in making frequency runs on the unknown.

The reference-frequency switch may be used as a multiplier for the *X* and *B* ranges by setting it to a value other than nearest the actual operating frequency. For measurement of very low impedances or admittances, the functions of the wide-range final balance controls and the narrow-range initial balance controls may be interchanged, and, to allow this use, the initial balance controls have accurately calibrated dials with about 15% the range of the main dials and with the lower range of their scales expanded.

By selection of detector connections, one can measure (1) the grounded, (2) the direct, or (3) the total delta

value, balanced or unbalanced, of the unknown element—a valuable ability not possessed by most other instruments.

FEATURES:

- Will balance for any unknown regardless of magnitude or phase angle.
- Switching and controls provide fast, convenient operation.
- 1% accuracy.
- Covers entire audio frequency range.
- Reads directly in ohms or micromhos.
- Can measure grounded, direct, or balanced impedances or admittances.

SPECIFICATIONS

Frequency Range: 20 cycles to 20 kc.

Impedance and Admittance Range: -∞ to +∞. If the absolute resistance is less than 1000 ohms and the absolute reactance is less than 1000 $\frac{f_0}{f}$ ohms, the unknown is

measured as an impedance. If the absolute conductance is less than 1000 micromhos and the absolute susceptance is less than 1000 $\frac{f}{f_0}$ micromhos, the unknown is

measured as an admittance. Under certain limited conditions, a choice of *Z* or *Y* measurements is possible.

Accuracy: For real component, *R* or *G*: = (1% + [2 ohms or 2 micromhos]) for the main dials; components of less than about 100 ohms (or 100 micromhos) can be measured on the auxiliary dials within = (1% + [0.2 ohm or 0.2 micromho]). For imaginary component,

X or *B*: = (1% + [$\frac{2f_0}{f}$ ohm or $\frac{2f}{f_0}$ micromho]) for the main dials;

= (1% + [0.2 $\frac{f_0}{f}$ ohm or 0.2 $\frac{f}{f_0}$ micromho]) for the

auxiliary dials. To obtain this accuracy in the measurement of small quadrature components at the higher frequencies, correction data, supplied in the operating instructions, must be applied. The absolute measurements of *X* and *B*, but not *R* and *G*, involves the frequency error of the exciting generator.

Maximum Applied Voltage: 130 volts rms on bridge, giving less than 32 volts on unknown.

Accessories Required: A calibrated oscillator or other suitable a-c generator, and a null detector. The TYPE 1210-C Unit Oscillator (page 110) and the TYPE 1212-A Unit Null Detector, (page 63) are recommended.

Accessories Supplied: 2 TYPE 274-NP Shielded Cables, for connections to generator and detector.

Mounting: Aluminum cabinet and panel. Crackle finish. Carrying handle provided.

Dimensions: Panel: (Width) 12½ x (height) 13½ x (depth) 8½ inches, over-all.

Net Weight: 21½ pounds.

Type	Code Word	Price
1603-A Z-Y Bridge	CATER	\$370.00

Elementary schematic diagram of the TYPE 1603-A Z-Y Bridge.

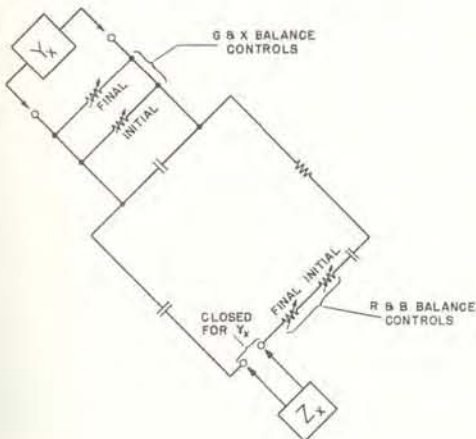

Reactance vs resistance for a typical loud speaker; data taken with Type 1603-A Z-Y Bridge.

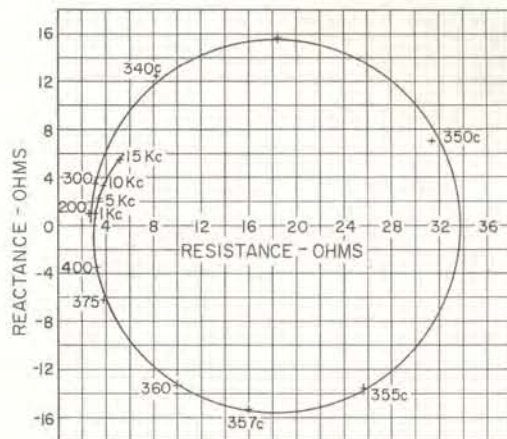



TYPE 1606-A RADIO-FREQUENCY BRIDGE

FOR THE MEASUREMENT OF ANTENNAS, LINES, NETWORKS
AND COMPONENTS FROM 400 KC TO 60 MC

USES: The TYPE 1606-A Radio-Frequency Bridge measures impedances simply and accurately at frequencies from 400 kc to 60 Mc. It measures directly the resistance and reactance of antennas, transmission lines, networks, and components. Although designed primarily for measuring the low values of impedance most often encountered in r-f devices, its range can be extended by means of an external parallel capacitor so as to measure high impedances, such as tuned circuits.

DESCRIPTION: The bridge circuit used is

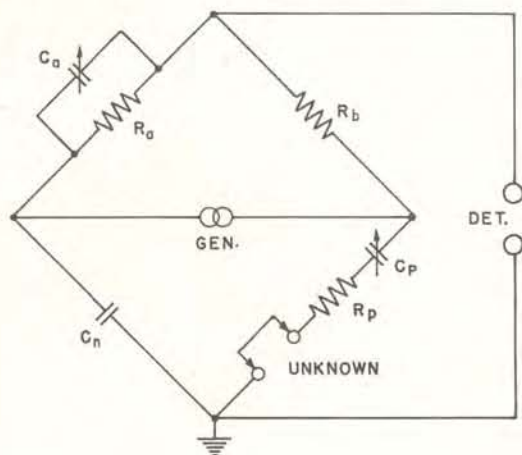

shown schematically in the diagram below. Measurements are made by a series-substitution method. The components of the unknown impedance are determined from the change in settings of capacitors C_A and C_P . The unknown reactance at 1 Mc is read directly in ohms from the dial of C_P , and the unknown resistance in ohms from the dial of C_A .

In making measurements the bridge is first balanced by means of capacitors C_P and C_A with a short-circuit across the unknown terminals. The short is then removed, the unknown impedance connected, and the bridge rebalanced. The resistance is then given by

$$R_x = R_B \frac{(C_{A2} - C_{A1})}{C_N}$$

and the reactance by

$$X_x = \frac{1}{\omega} \left(\frac{1}{C_{P2}} - \frac{1}{C_{P1}} \right)$$

where the subscripts 1 and 2 denote the dial readings for the initial and final balances respectively.

The resistive component is measured in terms of a fixed resistor (R_B), a fixed capacitor (C_N), and a variable capacitor (C_A). This feature is an important factor in the high-frequency performance of the bridge because residual parameters can be made much smaller in a fixed resistor and a variable capacitor



than in a variable resistor.

The TYPE 1606-A Bridge incorporates several important new advances in bridge design. A single, internal bridge transformer, used to couple an external generator to the bridge circuit, covers the entire 150:1 frequency range of the instrument while its triple shielding keeps undesired couplings to an insignificant level. A new type of variable air capacitor, having very low losses and inductance, is used for the reactance balances and the initial resistance balance. In this capacitor the complete rotor and stator sections are milled out of solid blocks of aluminum, a construction that avoids losses at the joints between plates and spacers and provides the utmost stability. Finally, the entire mechanical design is such that the instrument can operate under difficult environmental conditions similar to those specified for testing military electronics equipment, which makes the TYPE 1606-A Bridge an excellent instrument for portable field use.

FEATURES:

- High accuracy and reliability
- Fast, simple operation
- Wide frequency range
- Measures most impedances directly

SPECIFICATIONS

Frequency Range: 400 kc to 60 Mc.

Reactance Range: ±5000Ω at 1 Mc. This range varies inversely as the frequency; and at other frequencies the dial reading must be divided by the frequency in megacycles.

Resistance Range: 0 to 1000Ω.

Accuracy: For reactance at frequencies up to 50 Mc, ±(2% + 1Ω + 0.0008 × R × f), where R is the measured resistance in ohms and f is the frequency in Mc.

For resistance, at frequencies up to 50 Mc,

$$\pm \left[1\% + 0.0024f^2 \left(1 + \frac{R}{1000} \right) \right] \% \pm \frac{10^{-4} X}{f} \Omega + 0.1\Omega$$

subject to correction for residual parameters. R is the measured resistance in ohms, X is the measured reactance in ohms, and f is the frequency in Mc. At high frequencies, the correction depends upon the frequency and magnitude of the unknown resistance component. A chart from which the correction can be determined is given in the instruction book supplied with the bridge.

Satisfactory operation can be obtained at frequencies as low as 100 kc and somewhat above 60 Mc with not quite as good accuracy as indicated above. The f² term is important only at frequencies above 10 Mc. The 1/f term is important only at very low frequencies when the resistance of a high-reactance, low-loss capacitor is measured.

Terminals: Generator and detector terminals are TYPE 874

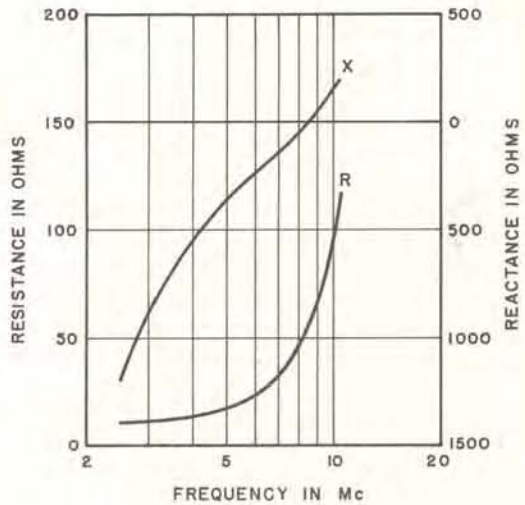

Reactance and resistance of an antenna system measured with the Radio-Frequency Bridge.

- Small, light, and rugged for field use—carrying case available
- Initial balance controls have locks to prevent accidental movement.
- Represents the best, most progressive practice in bridge design.

Coaxial Connectors. Adaptors to all commonly used coaxial connectors are available (see page 58).

Accessories Supplied: Two leads of different lengths for connecting the unknown impedance to the bridge terminals, one 1/2" spacer and one 3/4", 6-32 screw for mounting components directly on the bridge terminals, two TYPE 874-R22 Coaxial Cables for connecting the generator and detector, and one TYPE 874-PB58 Panel Connector.

Other Accessories Required: Radio-frequency generator and detector. The TYPE 1330-A Bridge Oscillator and the TYPE 1211-B Unit Oscillator are satisfactory generators, as are the TYPE 1001-A and the TYPE 805-C Standard-Signal Generators. At frequencies above 50 Mc a TYPE 1215-B Unit Oscillator or a TYPE 1021-AV Standard-Signal Generator is recommended. See pages 90-115.

A well-shielded communications receiver covering the desired frequency range makes a satisfactory detector. It is recommended that the receiver be fitted with the TYPE 874-PB58 Panel Connector or other coaxial connector to avoid leakage at the input connection.

Mounting: Welded aluminum cabinet supplied. A luggage-type carrying case is available separately and is recommended if the bridge is to be used as a portable field instrument.

Dimensions: 12 1/2 x 9 1/2 x 10 1/4 inches, over-all.

Net Weight: 23 pounds without carrying case; 29 pounds with carrying case.

Type		Code Word	Price
1606-A	Radio Frequency Bridge*	CIGAR	\$620.00
1606-P1	Luggage-type Carrying Case	BILLY	17.50

*PATENT NOTICE. See Notes 4 and 12, page x.





TYPE 916-AL RADIO-FREQUENCY BRIDGE

FOR THE MEASUREMENT OF ANTENNAS,
LINES, NETWORKS AND COMPONENTS
AT FREQUENCIES FROM
50 KC TO 5 MC

USES: The TYPE 916-AL Bridge measures impedances quickly and accurately at frequencies from 50 kc to 5 Mc. It measures directly the resistance and reactance of antennas, transmission lines, networks, and components. Although designed primarily for measuring the low values of impedance most often encountered in its frequency range, its impedance range can be extended by means of an external parallel capacitor so as to measure high impedances, such as tuned circuits.

DESCRIPTION: The circuit is similar to that of the TYPE 1606-A R-F Bridge used at higher frequencies (see page 30). Two transformers are used to cover the entire frequency range, the lower limit of which can be extended down to 15 kc for many measurements.

FEATURES:

- High accuracy and reliability
- Fast, simple operation
- Measures most impedances directly
- Suitable for field use
- ΔX Dial permits measurement of large capacitances and small inductances

SPECIFICATIONS

Frequency Range: 50 kc to 5 Mc. Satisfactory operation for many measurements can be obtained at frequencies as low as 15 kc.

Reactance Range: $\pm 11,000\Omega$ at 100 kc. This range varies inversely as the frequency, and at other frequencies the dial readings must be divided by the frequency in hundreds of kilocycles. To facilitate the measurement of small reactances, the instrument is provided with an incremental reactance dial which has a range of 100 ohms at 100 kc.

Resistance Range: 0 to 1000 Ω .

Accuracy: For reactance at frequencies up to 3 Mc,

$$\pm (2\% + 0.2 \times \frac{100}{f_{kc}} \Omega + 3.5f_{kc}^2 R \times 10^{-10}\Omega) \text{ where } R$$

is the measured resistance in ohms and f_{kc} is the frequency in kilocycles. The errors in reactance increase relatively rapidly at frequencies above 3 Mc; and at 5 Mc the accuracy is $\pm (2\% + 0.01\Omega + 2.3 R^{1.4} \times 10^{-3}\Omega)$.

For resistance, at frequencies up to 5 Mc, $\pm (1\% + 0.1\Omega)$, subject to correction for residual parameters at low frequencies. The correction depends upon the frequency and upon the magnitude of the unknown react-

ance component. A plot of this correction is given in the instruction book supplied with the bridge.

Accessories Supplied: Two input transformers, one covering the lower portion of the frequency range, the other the higher portion; two leads of different lengths (for connecting the unknown impedance); two 874-R22 Coaxial Cables for connecting generator and detector; one TYPE 874-PB58 Panel Connector.

Other Accessories Required: Radio-frequency generator and detector. The TYPE 1330-A Bridge Oscillator and the TYPE 1211-B Unit Oscillator are satisfactory generators as are the TYPE 1001-A and the TYPE 805-C Standard Signal Generators. A well-shielded radio receiver covering the desired frequency range makes a satisfactory detector. It is recommended that the receiver be fitted with the TYPE 874-PB58 Panel Connector supplied to avoid leakage at the input connection.

Mounting: Airplane-luggage type case with carrying handle. Both input transformers are stored inside the case. Coaxial cables, leads, and instruction book are stored in the cover of the instrument when not in use.

Dimensions: 17 x 13½ x 11½ inches, over-all.

Net Weight: 34½ pounds.

Type		Code Word	Price
916-AL	Radio-Frequency Bridge (50 kc to 5 Mc).....	CLUCK	\$620.00

PATENT NOTICE. See Notes 4 and 12, page x.



TYPE 1601-A V-H-F BRIDGE

USES: The TYPE 1601-A V-H-F Bridge is designed for the direct measurement of relatively low impedances at frequencies between 10 and 165 megacycles. It will measure high impedances indirectly. Among its applications are measurements on antennas, lines, networks, and components. It is particularly well adapted for the accurate measurement of 50 ohm coaxial systems, and is supplied with a coaxial adaptor to fit the bridge unknown terminal. For measurements on components and other lumped impedances, a pair of terminals (one grounded) or a single terminal with ground plane are provided.

DESCRIPTION: The measurement is made by a series substitution method using the same basic bridge circuit as the TYPE 1606-A Radio-Frequency Bridge (see page 30). The resistive and reactive components of the unknown impedance are measured in terms of incremental capacitances, and the magnitude of each is indicated on a separate dial. Calibrations are in ohms resistance and in ohms reactance at 100 megacycles.

Particular attention has been paid to the design of the bridge transformer and of the terminal structure to which the unknown impedance is connected, in order that the bridge be direct-reading, with a minimum of corrections.



FEATURES:

- This bridge is as convenient to use as those operating at much lower frequencies.
- Terminal arrangement permits both coaxial and lumped circuits to be measured.
- Bridge is small enough and light enough to permit its use in locations such as antenna towers which would be inaccessible to heavier equipment.
- Accuracy is better than that obtainable with other methods at these frequencies.
- Dials are direct-reading in both resistance and reactance.

SPECIFICATIONS

Frequency Range: 10 Mc to 165 Mc. Satisfactory operation can, for some measurements, be obtained at frequencies as low as 2 Mc and as high as 175 Mc.

Reactance Range: ± 200 ohms at 100 Mc. Dial range varies inversely with frequency and is calibrated at 100 Mc.

Resistance Range: 0 to 200 ohms, independent of frequency.

Accuracy: For resistance, $\pm(2\% + 1 \Omega)$ subject to correction for inductance in the capacitor used to measure resistance. The correction increases with frequency and with the magnitude of the resistive component. A correction chart is supplied with the instrument. The ohmic uncertainty indicated in the accuracy statement, namely 1 ohm, is roughly proportional to the magnitude of the reactive component of the unknown impedance. The indicated value is the maximum obtainable, and the minimum is 0.1 ohm.

For reactance, $\pm(5\% + 2 \Omega)$. The ohmic uncertainty is roughly proportional to frequency and to the magnitude of the resistive component. The maximum value is indicated, and the minimum value is 0.1 ohm at 100 Mc.

Accessories Supplied: Two TYPE 874-R22 Cables; one TYPE 1601-204 Coaxial Extension Assembly; one TYPE

874-WN Short-Circuit Termination; one Short-Circuiting Cap; one TYPE 874-PB58 Panel Connector; Smith Charts.

Other Accessories Required: R-F generator and receiver covering the desired frequency range; TYPES 1208-B, 1215-B, and 1330-A Oscillators are recommended, depending on frequency range (see pages 108-115). At frequencies above 40 Mc, the TYPE DNT-1 or -2 Detector (page 64) is a satisfactory receiver. Both oscillator and receiver should be reasonably well shielded. It is recommended that the receiver be fitted with the TYPE 874-PB Panel Connector supplied to avoid leakage at the input connection.

Additional Accessories Recommended: A TYPE 874-WM 50-ohm Termination is useful in checking the bridge adjustments. The generator and detector terminals are TYPE 874 Coaxial Connectors. Adaptors for connection to the various types of military connectors and to V-H-F and U-H-F rigid transmission lines are listed on page 58. An additional adapter will be needed when coaxial systems to be measured are fitted with military connectors.

Dimensions: (Length) $13\frac{1}{2}$ x (height) 9 x (depth) $10\frac{1}{2}$ inches, over-all.

Net Weight: 18 pounds.

Type		Code Word	Price
1601-A	V-H-F Bridge*†	FLORA	\$520.00
874-WM	50-Ohm Termination*	COAXMEETER	15.00

PATENT NOTICE: *See Note 4, page x. †See Note 13, page x.



TYPE 1602-B U-H-F ADMITTANCE METER

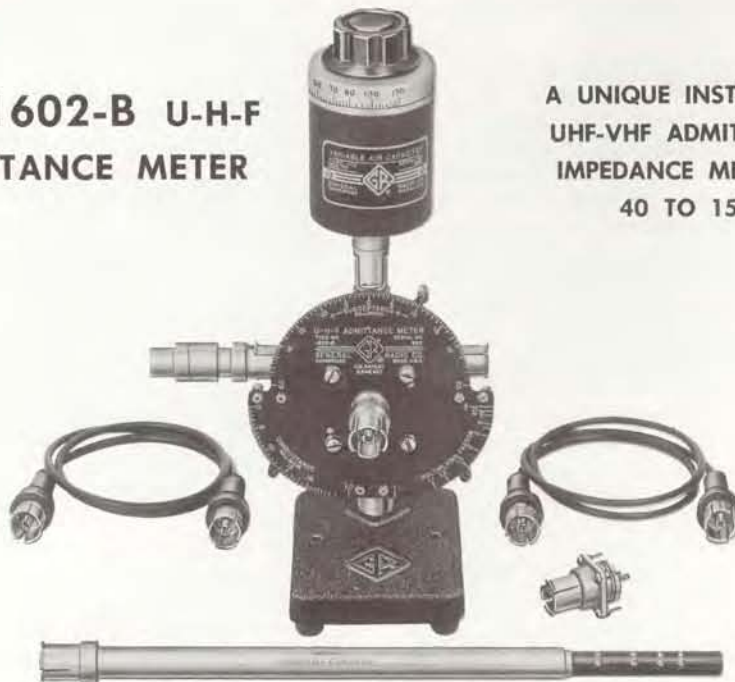

A UNIQUE INSTRUMENT FOR
UHF-VHF ADMITTANCE AND
IMPEDANCE MEASUREMENT
40 TO 1500 MC

USES: The Admittance Meter is a null-type instrument for determining the components of an unknown admittance in the VHF-UHF range. It is designed primarily for measurements on coaxial systems: antennas, lines, coaxial components, etc. It can be used as an indicator for adjusting a network to a predetermined admittance or for matching one network to another and is particularly useful in matching antennas and other networks to 50-ohm circuits.

As a comparator, the Admittance Meter can be used to determine impedance magnitude, reflection-coefficient magnitude, and voltage standing-wave ratio.

The usefulness of the Admittance Meter is greatly enhanced by the many accessories available for use with it. Among these are:

The TYPE 874-LK20 Constant Impedance Adjustable line (page 51), which can be set to one-half wavelength to eliminate corrections for the length of transmission line between the unknown and the measuring point. When the line is set to one-quarter wavelength, the Admittance Meter dials read directly in *impedance* parameters, i.e., the series resistance and reactance of the unknown.

The TYPE 874-UB Balun (page 50), for use in measuring balanced impedances, such as TV receiving antennas and transmission lines.

The TYPE 874-M Component Mount (page 55), which provides a convenient means of connecting lumped elements (resistors, capacitors, or inductors) to the Admittance Meter for measurement.

Adaptors (page 58) for all commonly used types of military connectors.

Adaptors (page 58) for Rigid VHF and UHF transmission lines used with TV transmitting antennas. With these adaptors and the adjustable line mentioned above, the overall accuracy of measurement is more than adequate for antenna measurements in design, test, and installation.

DESCRIPTION: The TYPE 1602-B Admittance Meter comprises a coaxial line to which the unknown is connected, a shielded pickup loop to sample the current, a second line and loop terminated in a pure resistance, and a third line and loop terminated in a pure reactance. All are fed from the same voltage source, so that their input voltages are in phase, and the current in each line is proportional to the admittance. The voltage induced in each loop is proportional to the current in the corresponding line and is dependent upon the orientation of the loop, which is adjustable.

The three loops are connected in parallel, and the voltage from the loop in the unknown line is canceled by adjusting the loops coupled to the standard lines until a null is reached.



Admittance Meter set up with component mount and adjustable line to measure resistors at 500 megacycles.

The conductance and susceptance of the unknown are read directly from the scales of the

standard loops, while the scale of the loop in the unknown line indicates multiplying factor.

FEATURES:

- Dial scales are direct-reading, independent of frequency.
- No sliding balance; real and reactive adjustments are independent.
- No initial balance is necessary.
- Wide-frequency range—direct-reading from 40 to 1500 megacycles; can be used at frequencies as low as 20 Mc.
- Covers completely both V-H-F and U-H-F television bands.
- Accurate, rapid and easy to use.
- Can be used with Type DNT Detector to measure VSWR directly by a simple ratio method.

SPECIFICATIONS

Range: Theoretically, zero to infinity; practically, the lower limit is determined by the smallest readable increment on the scale which is 100 micromhos (0.1 millimho). The upper limit is 1000 millimhos. Range is the same for both conductance and susceptance, but susceptance can be either positive or negative, i.e., the susceptance dial is calibrated from -20 to $+20$ millimhos. Multiplying factors from 1 to 20 are provided, and factors from 20 to 100 can be determined approximately.

Frequency Range: 40 to 1500 Mc, direct-reading. Range can be extended downward to 20 Mc, if a frequency correction is applied to the susceptance reading.

Accuracy: For both conductance and susceptance (up to 1000 Mc):

- from 0 to 20 millimhos = $(3\% + 0.2 \text{ millimho})$
 - from 20 to ∞ millimhos = $(3\sqrt{M}\% + 0.2 \text{ millimho})$
- where M is the scale multiplying factor. Above 1000 Mc, errors increase slightly, and, at 1500 Mc, the basic figure of 3% in the expression above becomes 5%. For matching impedances to 50 ohms, the accuracy is 3% up to 1500 Mc.

Accessories Supplied: One TYPE 1602-P4 50- Ω Termination, for use as conductance standard, and one TYPE 1602-P1 Adjustable Stub and one TYPE 1602-P3 Variable Air Capacitor, for susceptance standards; two TYPE 874-R22 Patch Cords for connections to generator and detector; and one TYPE 874-PB58 Panel Connector for installation on detector. A wooden storage case is furnished.

Additional Accessories Required: Generator and detector. Generator should cover desired frequency range and deliver between 1 volt and 10 volts. TYPE 1208-B (65 to 500 Mc), TYPE 1215-B (50 to 250 Mc), TYPE 1209-B (250 to 920 Mc) and TYPE 1218-A (900 to 2000 Mc) Unit Oscillators (see page 114), are recommended. The TYPE 1021-AU and AV Standard-Signal Generators are also satisfactory.

Detector sensitivity should be better than 10 microvolts. TYPE DNT Detectors (page 64) are recommended. **Other Accessories Available:** Coaxial adaptors (page 58); line stretcher (page 51); balun (page 48); and component mount (page 55); Smith charts (page 240).

Terminals: All terminals are TYPE 874 Coaxial Connectors. Adaptors are available for other coaxial systems (page 58).

Dimensions: $7\frac{1}{2} \times 5\frac{1}{2} \times 5\frac{1}{2}$ inches, without standards and unknown connected.

Net Weight: $8\frac{1}{4}$ pounds.

Schematic diagram of admittance meter circuit, with standards, generator, and null detector connected for admittance measurements.

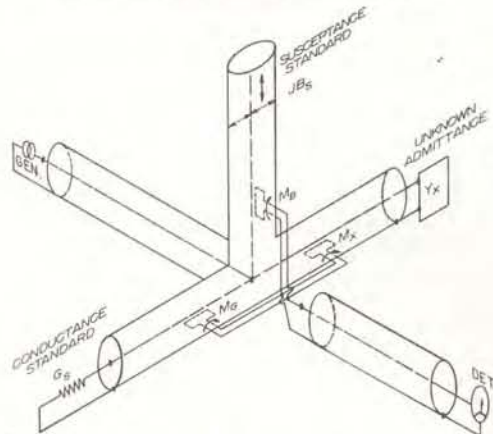

Type

1602-B

U-H-F Admittance Meter

Code Word

HONEY

Price

\$295.00

PATENT NOTICE. See Note 4, page x.

OTHER COAXIAL IMPEDANCE-MEASURING DEVICES: TYPE 1607-A Transfer Function Meter (page 36); TYPE 874-LBA Slotted Line (page 43); TYPE 874-LM Dielectric Measuring Line (page 46).

TYPE 1607-A TRANSFER-FUNCTION AND IMMITTANCE BRIDGE



Instrument with Transfer-Function Indicator mounted in place—Immittance Indicator for 2-terminal measurements is shown separately in front.

USES: The Transfer-Function and Immittance* Bridge is an entirely new, null-type instrument for very-high and ultra-high-frequency measurement of the forward and reverse transfer functions and the input and output impedances and admittances of 4-terminal electrical networks. Measurements may be made on either active devices, such as transistors and vacuum tubes, or passive devices, such as filters and attenuators. In addition, the impedance or admittance of two-terminal circuits or components can be easily measured.

This unique device uses a new method of measurement. It is simple to operate, and results are indicated directly in terms of the real and imaginary components of the quantity tested. When used to test transistors, the Transfer-Function and Immittance Bridge will measure characteristics that are not measurable with conventional transistor testers.

This basic measuring tool is indispensable to any laboratory engaged in vhf or uhf measurements. A few examples of the measurements that can be made are:

*Immittance = impedance and/or admittance

Transistors—

- short-circuit current ratio (α, β, h_f)
- open-circuit voltage feedback factor
- hybrid input impedance (h_i)
- hybrid output admittance (h_o)

Vacuum Tubes—

- open-circuit voltage gain
- transadmittance
- feedback admittance
- input admittance
- output admittance

General 2-terminal or 4-terminal Networks—

- forward and reverse transadmittance
- forward and reverse transimpedance
- forward and reverse transfer current ratio
- forward and reverse transfer voltage ratio
- input and output impedance
- input and output admittance

Ungrounded Components—

- inductors—inductance and self-resonances
- capacitors—capacitance and resonances
- resistors—resistance and shunt capacitance



Components, Coaxial Lines, and Other Grounded Elements

- admittance
- impedance
- reflection coefficient and VSWR

DESCRIPTION: The TYPE 1607-A Transfer Function and Immittance Bridge comprises three identical loops driven in parallel by an external generator and coupled, respectively, to three coaxial lines. Each loop can be rotated independently of the others, so as to vary its coupling to its associated line, and has a calibrated scale. The currents in all three loops are equal in magnitude and phase.

The network to be tested and two standards, one resistive and the other reactive, are energized through the loop couplings. The resulting three currents are combined in an external null detector, which indicates *when the currents all cancel*. The in-phase current from the resistive standard cancels the real component of current from the unknown, and the quadrature current from the reactive standard cancels the imaginary component of current from the unknown.

Two interchangeable loop- and-scale assemblies, (Transfer-Function Indicator and Immittance Indicator, respectively) allow either four-terminal or two-terminal networks to be measured with equal ease.

To connect unknown networks properly to the current-comparing circuit, two constant-impedance, adjustable-length, "trombone" lines are built into the instrument. These lines can be adjusted to different combinations of

Instrument storage box with accessories supplied, including low-frequency extension unit with lines and cables, rejection filter for local oscillator, standards, etc.



odd or even multiples of a quarter wavelength as required by the type of function to be measured. Adjustment range is sufficient for any type of measurement above 300 Mc, and the low-frequency extension lines of several lengths supplied can be quickly plugged into place for measurements down to 25 Mc.

The resistive and reactive standards are, respectively, a matched 50-ohm resistance termination and an adjustable stub or capacitor.

FEATURES:

- A versatile, high-frequency measuring tool—measures practically any network, active or passive
- Provides complete analysis of transistors, tubes, and two-terminal and four-terminal networks, active and passive
- Wide frequency range—25 to 1500 Mc.

Plot of alpha versus frequency for a 1957 experimental, high-frequency transistor supplied by Bell Telephone Laboratories (Grounded base connection).

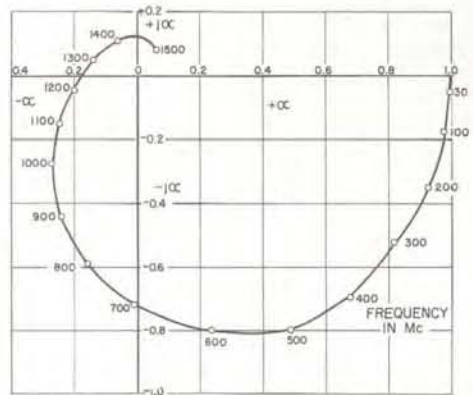

Transistor mounts available for making reproducible measurements on transistors having JETEC-30 base arrangement. TYPE 1607-P101 grounds the base lead; TYPE 1607-P102 grounds the emitter lead and both have removable, oscillation-damping resistor. Spring holds transistor firmly in place and grounds case.





Dial calibrations of Transfer-Function Indicator (left) and Immittance Indicator (right).

- Direct-reading
- Suitable both for laboratory measurements and for routine production measurements

- Component mounts available for commonly used transistors and tubes
- Built-in provisions for d-c biasing.

SPECIFICATIONS

Frequency Range: 25 to 1500 Mc, with reduced accuracy above 1000 Mc and when flexible cable is used in the lines. The use of this cable is required at frequencies below 150 Mc and is optional at other frequencies.

Measurement Range: Accuracy: (up to 1000 Mc)
Voltage and Current Ratios
 $(R) \quad 0-30 \quad 2.5 (1 + \sqrt{R})\% + 0.025$

Transimpedance (Z_{21}) $2.5 (1 + \sqrt{\frac{Z_{21}}{50}})\% + 1.25$ ohms
 0-1500 ohms

Transadmittance (Y_{21}) $2.5 (1 + \sqrt{\frac{Y_{21}}{20}})\% + 0.5$ mmho
 0-600 mmhos

Impedance (Z_{11}) $2.5 (1 + \sqrt{\frac{Z_{11}}{50}})\% + 1.0$ ohm
 0-1000 ohms

Admittance (Y_{11}) $2.5 (1 + \sqrt{\frac{Y_{11}}{20}})\% + 0.4$ mmho
 0-400 mmhos

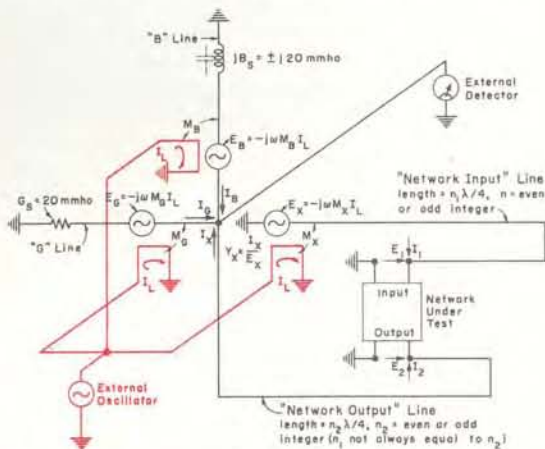

Schematic diagram of r-f circuits of the Transfer-Function and Immittance Bridge.

D-C Bias: Terminals are provided for introducing d-c bias from external sources. Maximum bias current, 100 ma; maximum bias voltage, 400 volts.

Accessories Supplied: Range-Extension Unit; Transfer-Function Indicator; Immittance Indicator; 6 terminations (open, short, matched, etc.); standards; 10-db attenuator; 8 air lines (21.5 and 43 cm); 3 U-line sections; constant-impedance adjustable line; a special tee; 10 patch cords; carrying case with storage space for instrument and accessories.

Accessories Required: Generator, detector, and mount for unknown device. Unit Oscillators (p. 114) and TYPE DNT Detectors (p. 64) are recommended. For coaxial adaptors see p. 58. See below for mounts available.

Other Accessories Available: TYPE 1607-P101 Transistor Mount for JETEC-30 base arrangement, grounded base. TYPE 1607-P102 Transistor Mount for JETEC-30 base arrangement, grounded emitter. TYPE 1607-P201 Tube Mount, 7-pin miniature grounded-cathode, for 6AF4, 6AF4A, and other tubes with same connections.

Case: The instrument, with accessories, is mounted in a wooden carrying and storage case.

Dimensions: case $11\frac{1}{4} \times 14\frac{1}{2} \times 40$ inches
Net Weight: 63 pounds.

Type		Code Word	Price
1607-A	Transfer Function and Immittance Bridge	HYDRA	\$1665.00
1607-P101	Transistor Mount (JETEC-30, grounded base)	TRANSMOUNT	60.00
1607-P102	Transistor Mount (JETEC-30, grounded emitter)	TORICMOUNT	60.00
1607-P201	Tube Mount, 7-pin miniature, grounded cathode	TUBESMOUNT	75.00

PATENT NOTICE. See note 4, page x.

TYPE 1661-A VACUUM-TUBE BRIDGE

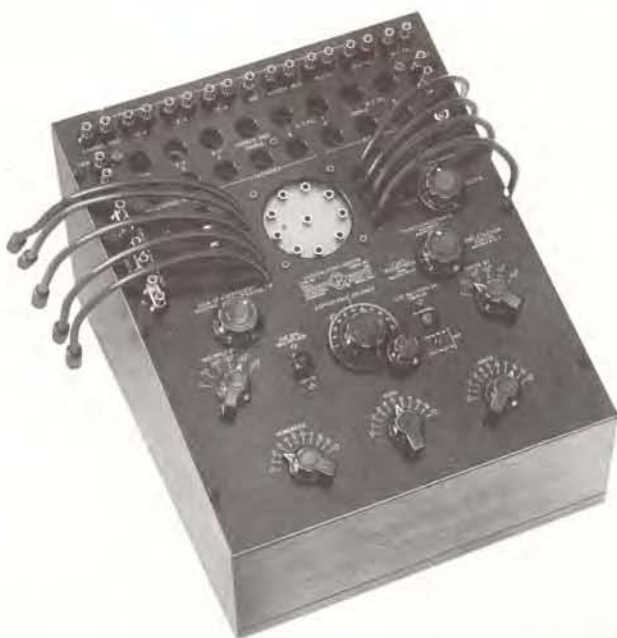

USES: The TYPE 1661-A Vacuum-Tube Bridge makes possible the measurement of the low-frequency dynamic coefficients of vacuum tubes and transistors over very wide ranges of values and under a wide variety of operating conditions.

For vacuum tubes, independent, direct-reading measurements of forward and reverse voltage-amplification factor, resistance, and transconductance can be made quickly and easily.

For transistor applications, within the range and sensitivity of the bridge one can determine the short-circuit conductance parameters including the h_i hybrid parameter and the forward- and reverse-voltage ratios including the h_r hybrid parameter. The h_f , α , and β factors can be determined from the ratio of two conductance measurements. Other open-circuit parameters can be calculated from the short-circuit parameters. In some cases they can be measured directly under effective open-circuit conditions if careful external shielding is provided where required.

Although not intended for the service-testing of tubes and transistors, the vacuum-tube bridge is more than adequate for the rugged job of production testing, and it is a most accurate device for evaluating tube coefficients and most transistor low-frequency parameters.

In development and research, this instrument affords a means of studying the behavior of tubes and transistors used in unconventional

and special circuits, where any one of the electrodes may be used as the control electrode and where the parameters may have negative values.

The circuits have large enough current-carrying capacity and sufficient insulation so that transmitting tubes can be tested, in addition to receiving tubes and transistors.

DESCRIPTION: The bridge makes use of alternating-current null methods of measurement, in which phase-shift and capacitance errors have been given special consideration in order that the operating range of the bridge may be as wide as possible. Each of the three coefficients is obtained in terms of the ratio of two alternating test voltages. A third voltage is employed in the capacitance balancing circuit, but its value does not enter into the results.

An extremely flexible arrangement of the control circuits makes it possible to measure the resistance, voltage ratio, and transconductance parameters referred to any pair of electrodes. Connections from the tube or transistor under test to the measuring circuit are made by means of coaxial cables and jacks connected to a nine-terminal jack plate mounted on the panel. Unused cables can be secured to or grounded to the panel. Sixteen coaxial plugs are mounted on the panel, permitting a wide variety of interconnections between the jack plate, the measuring circuit, and external power supplies.



Twelve adaptor plates for plugging in tubes and transistors (see specifications) are provided.

In this latest version of the Vacuum-Tube Bridge, selection of either of two internal resistance standards permits operation at a bridge ratio that yields improved sensitivity at the resistance and transconductance extremes.

A switch permits the independent testing of both sections of two-section tubes without the need for reconnecting patch cords.

Self-bias resistors can be connected for either single- or two-section tubes.

The operating frequency can be 270-400 cycles or 1000 cycles.

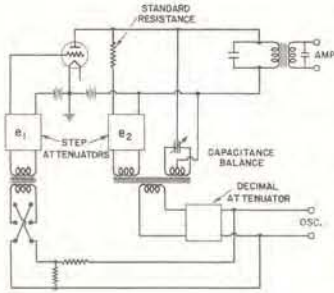

Simplified diagram of the circuit employed for the measurement of transconductance with the TYPE 1661-A Vacuum-Tube Bridge. The a-c plate current resulting from the application of e_1 to the grid is balanced by an equal and opposite current applied to the plate from the source e_2 , through the standard resistance. The setting of the decimal attenuator at the bottom of the panel gives the significant figures in the result, and the settings of the step attenuators (e_1 and e_2) indicate multiplying factors (MULTIPLY BY and DIVIDE BY on the panel switches).

Any quadrature component through the output transformer resulting from the tube interelectrode capacitances can be balanced out by the voltage of the extra split secondary, acting through the double-stator capacitor. This balance does not affect the balance conditions for the in-phase components and consequently has no effect on the measurement.

The points of introduction of the test voltages e_1 and e_2 are changed by a switch when the other coefficients are measured. Another switch reverses the polarity of e_1 when negative values of the coefficients are to be measured.

SPECIFICATIONS

Range: Amplification factor (μ), 0.001 to 10,000.

Dynamic internal plate resistance (r_p), 50 ohms to 20 megohms.

Transconductance (g_m), 0.02 to 50,000 micromhos.

Under proper conditions, the above ranges can be exceeded. The various parameters can also be measured with respect to various elements, such as screen grids, etc. Negative as well as positive values can be measured.

Accuracy: Within $\pm 2\%$ for resistances (r_p switch position) from 1000 to 1,000,000 ohms. At lower and higher values the error increases.

The expression $\mu = r_p g_m$ will check to $\pm 2\%$ when the quantities are all measured by the bridge, and when r_p is between 1000 and 1,000,000 ohms.

Tube and Transistor Mounting: Adaptors are provided for 3- and 4-lead transistors (including JETEC 30) and for tubes of 4-pin, 5-pin, 6-pin, small 7-pin, large 7-pin, octal, loctal, miniature button 7-pin, miniature button 9-pin (noval), acorn (5- and 7-pin), flat-press sub-miniature up to 7 wires, and 8-wire sub-miniar. In addition, a universal adaptor, with nine soldering lugs, is provided so that unbased transistors, unmounted tubes, or tubes with non-standard bases, can be measured conveniently. For short-lead sub-miniature tubes and for transistors, sockets are supplied which can be mounted on the universal adaptor. Thus all standard commercial receiving

FEATURES:

➤ A simple and straightforward measurement procedure is used and is exactly the same for all three coefficients. At balance, the quantity being measured is indicated directly to three figures by bridge dial settings.

➤ Independent measurements of the three main tube parameters are possible, i.e., none of the balances depends in any way on any other.

➤ Negative values of the coefficients can be measured as readily as positive values.

➤ The transconductance of a tube having a high value of grid-to-plate capacitance can be measured without error from this capacitance.

➤ Low-frequency parameters of transistors can be measured.

tubes and transistors can be measured. The panel jack plate and the adaptors are made of low-loss (natural) phenolic, reducing to a minimum the shunting effect of dielectric losses on the dynamic resistance being measured.

Current and Voltage Ratings: Maximum allowable plate current, 400 ma; maximum plate voltage, 1500 volts.

Electrode Voltage Supply: Batteries or other suitable power supplies are necessary for providing the various voltages required by the device under test.

Bridge Source: TYPE 1214-E Oscillator is recommended.

Null Detector: The TYPE 1212-A Unit Null Detector with the TYPE 1951-E Filter is recommended (see pages 61 to 64).

Accessories Supplied: Adaptors as listed above, all necessary plug-in leads, and shielded patch cords for connecting generator and detector.

Mounting: The instrument is mounted in a hardwood cabinet. A wooden storage case is provided for the adaptors and leads. Storage space is provided for a spare Universal adaptor, on which any type of socket can be permanently mounted.

Dimensions: (Length) $18\frac{1}{2}$ x (width) $15\frac{3}{4}$ x (height) 11 inches.

Net Weight: TYPE 1661-A weighs 40 pounds. The accessories supplied and the accessory box weigh 14 pounds.

Type	Code Word	Price
1661-A Vacuum-Tube Bridge	BEIGE	\$975.00



COAXIAL INSTRUMENTS AND COMPONENTS



Figure 1. (left) A view of TYPE 874 Coaxial Connector. Figure 2. (right) Cross section of two connectors plugged together.

The TYPE 874 Coaxial Elements are a group of precision-built, but inexpensive, coaxial parts that can be plugged together quickly and easily to assemble different measuring systems in the frequency range from dc to 5000 megacycles.

This complete and integrated line of measuring equipment is extremely well suited for performing the essential measurements in the development, test, and operation of vhf and uhf equipment including radar, television, military communication, and navigation systems.

The basic instruments are (1) a slotted line for impedance and standing-wave-ratio measurements, with optional motor drive for automatic operation; (2) a slotted line designed especially for dielectric measurements on solid materials; (3) a crystal rectifier and indicator

for voltage measurements; (4) a crystal mixer for frequency conversion and use with an i-f amplifier as a heterodyne detector; and (5) a balun for measurements on balanced-line systems. Two other coaxial instruments for impedance and admittance measurements on two- and four-terminal networks, the Admittance Meter and the Transfer-Function and Immittance Bridge, are listed on pages 34 to 38.

These basic devices are supplemented by all the necessary accessory parts — attenuators, filters, stubs, terminations, lines, and patch cords — as listed in the index below.

The keystone of the entire system is the TYPE 874 Coaxial Connector. This unique connector, *any two of which, although identical, can be plugged together*, is specifically designed for use on coaxial measuring equipment. Its

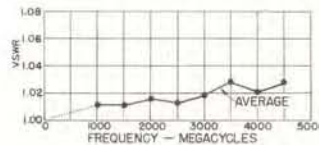

Figure 3. VSWR of a typical Type 874 Coaxial Connector.

INDEX BY FUNCTION

	Page		Page		Page
Adaptors	58	Couplers	53	Patch Cord	56
Attenuators	54	Dielectric Measuring Line	46	Slotted Line	43,46
Balanced Measurements	48	Filters	49	Stand	55
Balun	48	Insertion Unit	55	Stubs	53
Cable	56	Lines and Line Elements	51	Terminations	52
Cliplock	55	Mixer-Rectifier	49	Tuning Elements	53
Component Mount	55	Motor Drive for Slotted Line ..	45	Voltage Measurements	50
Connectors	57				

PATENT NOTICE. See Note 4, page x.

INDEX BY TYPE DESIGNATION

Type	Page		Page		Page
874-A2, -A3	56	-LM	46	-QU1, -QU2A, -QU3A, -QV2A,	
-B	57	-LR	53	-QV3	58
-BM	48	-LV	44	-R22, -R34	56
-C, -C8, -C9, -C58, -C62	57	-M	55	-T	53
-D20, -D50	53	-MB	53	-UB, -UB-P2, -UB-PS,	
-EK	47	-MD	45	-UB-P4	48
-EL	53	-MR	49	-VC	53
-F185, -F500, -F1000, -F2000,		-P, -P8, -P9, -P58, -P62	57	-VI, -VQ, -VR	50
-F4000, -FR1, -FR2, -FR3	49	-PB, -PB8, -PB9, -PB58,		-WM, -WN, -WN3, -WO,	
-GA, -G3, -G6, -G10, -G20	54	-PB62	57	-W03, -W100, -W200	52
-JR	53	-Q2, -Q6, -Q7, -QBJ, -QBP,		-X	55
-K	53	-QCJ, -QCP, -QHJ, -QHP,		-XL	53
-LA, -LK10, -LK20, -LT,		-QLJ, -QLP, -QLTJ, -QLTP,		-Y	55
-L10, -L20, -L30	51	-QNJ, -QNP, -QSCJ, -QSCP,		-Z, -ZC	55
-LBA	43	-QTNJ, -QTNP, -QUJ, -QUP,			





Figure 4. Cutaway view of basic connector joined with cable connector.

quick-connect-and-disconnect feature simplifies the assembly of coaxial elements into complete measurement setups, and its reflections at ultra-high frequencies are so low that they can usually be neglected (see Figure 3).

The basic elements of the TYPE 874 Coaxial Connector are an inner conductor, an outer conductor, and a supporting polystyrene bead. Figure 1 shows the open end of one of these connectors. The inner and outer conductors are similar in principle; each is essentially a tube with four longitudinal slots in the end and with two opposite quadrants displaced inward. To make a joint, two connectors are plugged together so that the undisplaced quadrants of one connector overlap the displaced quadrants of the other. Figure 2 is a cross-section sketch of a joint in which the elements of one connector are shaded dark and those of the other light. The mutual overlapping can be seen, as well as the resultant circularity of the joined conductors.

Figure 4 is a cutaway view of two connectors, one attached to a cable, the other to a rigid line.

A minimum of parts is necessary to assemble any given setup, since all connectors are identical, eliminating the need for both male and female connectors. For connection to devices equipped with other types of connectors, a complete line of low-reflection adaptors to military-type cable and rigid-line connectors is available.

These adaptors, (page 58) are useful not only for connection to UG and other connectors, such as TYPES N, C, HN, LC, SC, TNC, LT, and BNC but also provide a means of interconnections between any two of these types. Figure 5 shows how a TYPE 874-QCP and a TYPE 874-QNJ can be used to connect between a TYPE C jack and a TYPE N plug.

The low standing-wave ratio of these adaptors is shown on page 58. Note that the plotted VSWR is the total of *two* TYPE 874 joints *plus* the one UG joint.

In the assembly of TYPE 874 Coaxial Elements into specific measurement systems, the TYPE 874-Z Stands offer a convenient means



Figure 5. TYPE 874-QCP and a TYPE 874-QNJ Adaptors plugged together. This assembly will connect a TYPE C jack to a TYPE N plug.

of holding the assembly rigid (see Figure 6). To prevent connectors from pulling apart during circuit adjustments, the TYPE 874-Y Cliplock is recommended.

To work with coaxial instruments, every laboratory needs a reliable detector system. The TYPE DNT Detectors, incorporating a coaxial mixer and a 30-Mc i-f amplifier are designed for dependable performance, sensitivity, and linearity. They can be used as null detectors, voltmeters, signal-strength meters, gain and loss meters, and crosstalk meters. For a complete description, see page 64.

By means of the TYPE 874-UB Balun and the TYPE 874-UB-P3 Balun Terminal Pad, a 50-ohm signal generator with grounded output can be converted to 300-ohm balanced output.

The TYPE 874-M Component Mount provides a ready means of evaluating the characteristics of resistors, capacitors, and inductors at high frequencies. It makes possible measurements under known, repeatable conditions and can be used with the TYPE 874-LBA Slotted Line, the TYPE 1602-B UHF Admittance Meter, and the TYPE 1607-A Transfer-Function and Immittance Bridge.



Figure 6. TYPE 874-Z Stands used to provide support for elements of a coaxial system.

TYPE 874-LBA SLOTTED LINE

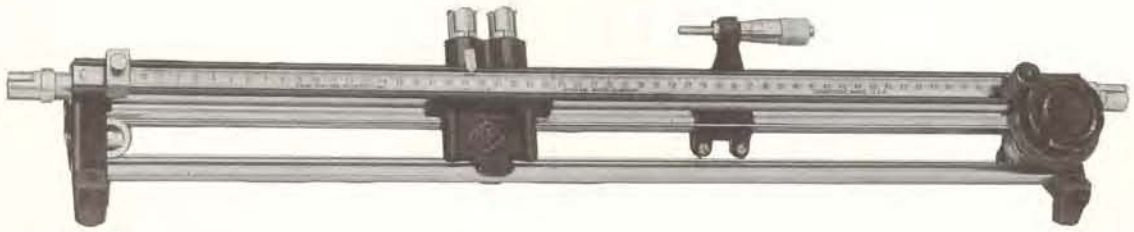

View of TYPE 874-LBA Slotted Line with TYPE 874-LV Micrometer Vernier.

USES: One of the most important basic measuring instruments used at UHF is the slotted line. With it, the standing-wave pattern of the electric field in a coaxial transmission line can be measured, from which the standing-wave ratio, phase of the reflected wave, impedance of the load, wavelength of the r-f signal, losses in attached elements, degree of mismatch between load and line, and other characteristics of antennas, components, coaxial elements and networks can be determined.

With the TYPE 874-MD Slotted-Line Motor Drive, standing-wave patterns can be displayed and measured directly on an oscilloscope, with a great increase in speed of measurement.

DESCRIPTION: The slotted line is a 50-ohm, air dielectric, coaxial transmission line, whose electric field is sampled by a probe that projects through a longitudinal slot in the line. Probe coupling is adjustable. The probe carriage is driven positively by an arrangement of pulleys and nylon cord, conveniently operated from the end of the line, which permits very precise settings. A source of r-f power of about one milliwatt is adequate for most

measurements. Suitable generators are listed on the next page.

A crystal rectifier is built into the carriage and can be tuned to the operating frequency with an adjustable stub. The crystal output can be used to deflect a microammeter, or, if the driving oscillator is modulated, to operate an audio amplifier. Another excellent detector is a heterodyne type with a crystal mixer and i-f amplifier. All three types are described on the next page.

The TYPE 874-LV Micrometer Vernier Attachment makes possible very precise measurements of high standing-wave ratios by the width-of-minimum method.

FEATURES:

- Well designed, precisely constructed, highly accurate.
- Moderately priced
- Can be motor driven for rapid, automatic measurements.
- Self-cleaning and lubricating
- Wide variety of accessory units available (see following pages)
- Low-reflection adaptors are available for other types of coaxial connectors.

SPECIFICATIONS

Characteristic Impedance: 50 ohms $\pm 1\%$

Probe Travel: 50 cm, scale calibrated in millimeters.

Scale Accuracy: $\pm (0.1 \text{ mm} + 0.05\%)$

Frequency Range: 300 to 5000 Mc; Operation below 300 Mc is possible by use of lengths of TYPE 874 Air Lines.

Accuracy: Constancy of probe penetration, $\pm 1\frac{1}{2}\%$.

Residual VSWR: Less than 1.025 at 1000 Mc, less than 1.07 at 4000 Mc.

Accessories Supplied: Storage box and spare drive cable.

Accessories Required: Adjustable Stub (TYPE 874-D20) for tuning the crystal rectifier when audio-frequency detector or microammeter is used; suitable detector and generator

(see page 44); one each TYPE 874-R22 Flexible Line and TYPE 874-R34 Patch Cord for generator and detector connections.

Accessories Available: See index on preceding page. A complete kit of TYPE 874 Coaxial elements including the slotted line is described on page 47. For measurement of high VSWR (greater than 10), a TYPE 874-LV Micrometer Vernier is recommended. For rapid measurements, use the TYPE 874-MD Slotted-Line Motor Drive. Smith Charts listed on page 240.

Dimensions: 26 x 4 $\frac{1}{2}$ x 3 $\frac{1}{2}$ inches over-all.

Net Weight: 8 $\frac{1}{2}$ pounds.

Type	Code Word	Price
874-LBA Slotted Line.....	COAXRUNNER	\$220.00



SLOTTED-LINE ACCESSORIES

MICROMETER VERNIER ATTACHMENT

For use in the measurement of high standing-wave ratios by the width-of-minimum method. Consists of a micrometer head, calibrated in centimeters (graduated to 0.001 cm), mounted on an arm that can be attached to the rear base rod of the slotted line. One turn of the micrometer barrel advances the head by 0.5 millimeter.

Maximum range is 2 cm. Can be read to ± 0.0002 cm. See photograph on page 43.

Type	Price
874-LV Micrometer Vernier Attachment ...	\$25.00

(Code Word: COAXREADER)

FILTERS

A low-pass filter should be used between generator and slotted line to eliminate harmonics of the signal source. Filter cut-off should be chosen to pass fundamental, but not harmonics. See page 58 for complete specifications.

Type	Cut-off Frequency	Price
874-F185	185 Mc.....	\$25.50
874-F500	500 Mc.....	16.00
874-F1000	1000 Mc.....	14.00
874-F2000	2000 Mc.....	14.00
874-F4000	4000 Mc.....	14.00

GENERATORS

The following generators are recommended: (TYPE 1021-AU or AV Standard Signal Generators are also satisfactory)

Type		See Page	Price
1215-B	Unit Oscillator, 50-250 Mc.....	114	\$190.00
1208-B	Unit Oscillator, 65-500 Mc.....	114	210.00
1209-B	Unit Oscillator, 250-920 Mc.....	114	245.00
1218-A	Unit Oscillator, 900-2000 Mc.....	114	465.00
1220-A	Unit Oscillator, 2700-7425 Mc...	116	*

*Price depends upon frequency, see page 116.

If a modulated signal is desired, the TYPE 1214-A Unit Oscillator for sine waves and the TYPE 1210-C Unit Oscillator are recommended to supply the modulating signal.

These unit oscillators do not include power supply; the TYPE 1203-B Unit Power Supply is recommended for general use. Where line voltage is subject to frequent variations, the TYPE 1201-B Unit Regulated Power Supply should be used.

Type		See Page	Price
1203-B	Unit Power Supply.....	143	\$40.00
1201-B	Unit Regulated Power Supply ...	143	85.00

Type		See Page	Price
1214-A	Unit Oscillator.....	110	\$75.00
1210-C	Unit R-C Oscillator.....	106	180.00

DETECTORS

AUDIO AMPLIFIER AND BUILT-IN CRYSTAL RECTIFIER

This detector has adequate sensitivity and shielding and covers the complete frequency range. A low-pass filter is recommended. Requires modulated oscillator.

Type		See Page	Price
1231-BM*		61	\$260.00
1231-P2	Filter.....	62	38.00
1231-P4	Adjustable Attenuator.....	62	70.00
874-D20	Stub.....	53	14.00
Total for TYPE 1231-BM and accessories.....			\$382.00

*Battery-operated model. An a-c operated model is also available.

HETERODYNE DETECTOR

More sensitive linear detector for this and other laboratory uses. First cost is higher than audio amplifier (above) but range of application is large. Best, general-purpose, uhf detector. See page 64.

Type		Price
DNT-1	40 to 530 Mc.....	\$626.00
DNT-3	220 to 950 Mc.....	659.00
DNT-4	870 to 2030 Mc†.....	879.00

†Up to 5000 Mc by use of harmonics

MICROAMMETER AND BUILT-IN CRYSTAL

Simple, but sensitivity is low. Can be used satisfactorily with high power oscillators. Excellent results have been obtained with a 50 μ a meter and oscillator power between 100 mw and 20 watts for VSWR's between 1 and 5.

Tuning stub is required. Meter sensitivity control consisting of a 10 k Ω variable shunt resistor is recommended.

Type		Price
874-D20	20 cm Stub.....	\$14.00



TYPE 874-MD SLOTTED LINE MOTOR DRIVE

FOR RAPID MEASUREMENTS OF VSWR AND IMPEDANCE

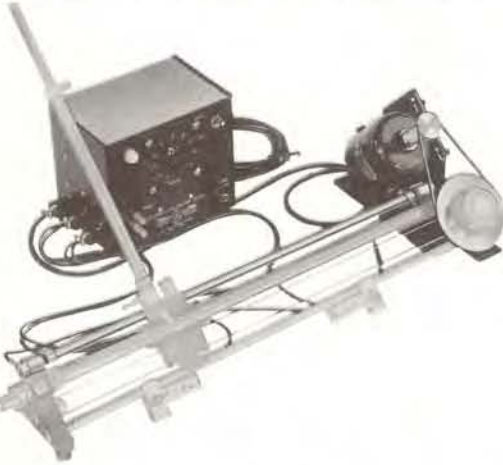

USES: The motor drive provides an automatic cyclic sweep of the probe carriage along the TYPE 874-LBA Slotted Line, so that the standing-wave pattern can be displayed on a cathode-ray oscilloscope. The resultant speeding-up of the measurement process saves valuable engineering time in the laboratory and makes it possible to utilize the inherent accuracy of slotted-line methods in production testing. Both VSWR and position of minimum can be read directly from the scope pattern. At lower sweeping speeds a VSWR meter indication can be used.

DESCRIPTION: The driving motor attaches easily to the right-hand end of the slotted line and drives the probe carriage by means of a V-belt and a pulley that replaces the control knob on the slotted line. The pulley is equipped with a knob, so that manual operation is also possible. A synchronized horizontal-sweep voltage is generated by a linear sweep potentiometer that attaches to the back of the slotted line, with a sliding contact element attached to the carriage. Switches, mounted on movable brackets, determine the travel of the carriage and provide the reversing control. The motor-control circuits are housed in a separate cabinet, connected to the slotted-line assembly by plug-in cables.

The entire unit can be installed on the slotted line in less than 5 minutes.

FEATURES:

- Saves time.
- Makes possible highly accurate *direct-reading* VSWR measurements.
- Adjustable sweep speed and sweep length.
- Can be used with VSWR meter at slow speeds.
- Oscilloscope grid overlay provided for direct indication of VSWR.

Typical standing-wave pattern obtained when generator is square-wave modulated. The direct-reading scales are on transparent overlays mounted on the face of the oscilloscope tube.



SPECIFICATIONS

Length of Sweep: Adjustable, 1 cm to 47 cm.

Sweep Speed Range: For complete sweep (47 cm), from one sweep in 20 seconds to better than 1 per second; for shorter sweeps to 5 per second.

Maximum Horizontal Sweep Voltage: 7 volts.

Accessories Supplied: Cables for connections; clamping circuit; 5-inch oscilloscope mask with VSWR scale; two Patch Cords; spare subminiature switch; spare actuator; spare cushioned sliding contact; spare fuses.

Power Supply: 105 to 125 volts, 50 to 60 cycles.

Net Weight: 16 $\frac{3}{4}$ pounds.

Other Equipment Required: One TYPE 874-G10 Fixed Attenuator, one 30-kilohm resistor, generator and detector as listed below:

Type		Code Word	Price
874-MD*	Slotted-Line Motor Drive	STORY	\$295.00
874-G10	Fixed Attenuator (10db)	COAXBELLER	30.00

* For 210 to 250-volt service, 50 to 60 cycles, order TYPE 874-MDQ18; Code Word, STORYREPEL Price, \$420.00.

Method	Generator	Frequency Range	Modulator	Detector* Arrangement
Square-Wave Modulation	TYPE 1218-A Unit Oscillator TYPE 1220-A Unit Klystron Oscillator	900-2000 Mc 2700-7450 Mc	TYPE 1210-B Unit Oscillator None	Oscilloscope † (10 mv/in. d-c. sensitivity)
Sine-Wave Modulation	TYPE 1208-B Unit Oscillator TYPE 1209-B Unit Oscillator TYPE 1218-A Unit Oscillator	65-500 Mc 250-920 Mc 900-2000 Mc	TYPE 1214-A Unit Oscillator or TYPE 1210-B Unit Oscillator	Oscilloscope † (0.1v in. d-c. sensitivity), or TYPE 1231-B Amp. and Null Det.
Unmodulated Source	TYPE 1208-B Unit Oscillator TYPE 1209-B Unit Oscillator TYPE 1218-A Unit Oscillator TYPE 1220-A Unit Klystron Oscillator	65-500 Mc 250-920 Mc 900-2000 Mc 2700-7450 Mc	None	Oscilloscope † (10 mv/in. d-c. sensitivity)

* Alternatively, one of the TYPE DNT Detectors (page 65) will provide a linear, as contrasted with a square-law, oscilloscope display.
† A high-persistence oscilloscope screen (P7 Phospor) is recommended.

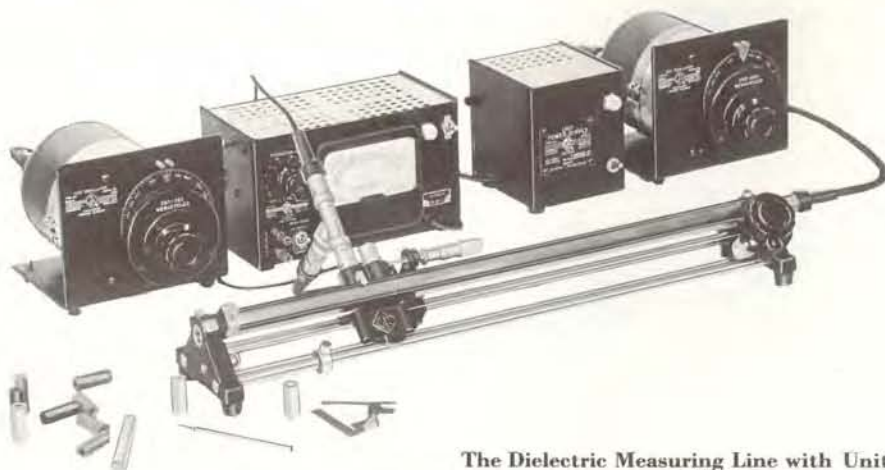

The Dielectric Measuring Line with Unit Oscillator and DNT Detector.

TYPE 874-LM DIELECTRIC MEASURING LINE

USES: This newly developed slotted line is used to measure, by a simplified method, the dielectric constant and loss of solid dielectric materials in the frequency range from 200 to 5000 Mc. With the TYPE 874-LM Dielectric Measuring Line, high frequency dielectric measurements are as simple as low frequency measurements with an ordinary bridge.

The range of measurement covers most ordinarily used dielectric materials. The dissipation-factor range, 0 to 0.05, includes such low-loss materials as polystyrene and Teflon and the higher-loss materials of most commonly used insulators. The dielectric-constant range, 1 to 10, extends from vacuum (or air) to steatite, porcelain, glass, and most of the commonly used plastics. The accuracy of this instrument makes it suitable for laboratory measurements, while its speed and simplicity of operation make it suitable for routine, production-type measurements.

DESCRIPTION: The TYPE 874-LM Dielectric Measuring Line is effectively a slotted line and sample holder as one integral unit. The line has silver-overlaid inner and outer conductors to minimize line losses and permit measurements on very low-loss materials. The line is sufficiently long to accommodate cylindrical samples up to 45 centimeters in length. The sample is inserted flush with the

end of the line inner conductor and a movable probe is used to locate a voltage minimum on the air-filled section of line near the inner face of the sample. Dielectric constant is obtained from the sample length, voltage minimum position, and frequency, while the dissipation factor is obtained from a measurement of the width of the voltage minimum.

In the simplified method either the sample length or the frequency is adjusted to make the electrical length of the sample approximately an odd multiple of a quarter-wavelength.

A micrometer vernier is included to facilitate accurate measurement of the width of the standing-wave minimum.

For a complete description, see *General Radio Experimenter*, 32, 12, May, 1958.

FEATURES:

- High accuracy
- Wide range of measurement
- Wide frequency range
- Simple procedure
- Low cost
- Samples are easily machined

SPECIFICATIONS

Frequency Range: Minimum, $\frac{200}{\sqrt{K}}$ Mc; Maximum, 5000

Mc or $\frac{9000}{\sqrt{K}}$ Mc, whichever is the smaller.

Measurement Ranges and Accuracies: Dielectric Constant (K) $\pm 2\%$ for values of K between 1 and 10; Dissipation Factor (D) $\pm (5\% + 0.0001)$ for values of (D) between 0 and 0.05.

Sample: Cylindrical; O.D., 0.561 inches; I.D., 0.250 inches; length depends upon dielectric constant and frequency; long samples can be made up of a number of short sections. Maximum length, 45 cm.

Maximum Operating Temperature: 75° C.

Micrometer Scale: Can be read to 0.0002 cm.

Accessories Supplied: TYPE 874-LV Micrometer Vernier. Tools to facilitate insertion and removal of dielectric samples.

Additional Accessories Required: Generator and detector; Unit Oscillators (p. 114) with TYPE 1201-B Unit Regulated Power Supply, and TYPE DNT Detectors (p. 64) respectively, are recommended. One TYPE 874-G6 6-db Pad and one TYPE 874-G3 3-db Pad. TYPE 874-F Filters for the frequency range used are also recommended.

Dimensions: 26 x 4 1/2 x 3 1/2 inches, over-all.

Weight: 9 1/2 pounds.

Type		Code Word	Price
874-LM	Dielectric Measuring Line	COAXFACTOR	\$400.00





COAXIAL KITS



TYPE 874-EK BASIC SLOTTED LINE KIT

For impedance and standing-wave measurements with the slotted line, a group of coaxial elements as listed below has been selected and

is available as the TYPE 874-EK Basic Slotted Line kit. Generator and detector are not included (see page 44).

Type	Name	Quantity	Unit Price	Price
874-A2	Coaxial Cable	25 feet	\$27.00/100 feet	\$ 6.75
874-B	Basic Connector	2	1.25	2.50
874-C	Cable Connector	2	2.00	4.00
874-C8	Cable Connector	2	2.00	4.00
874-D20	Adjustable Stub	1	14.00	14.00
874-D50	Adjustable Stub	1	14.00	14.00
874-LA	Adjustable Line	1	17.50	17.50
874-LBA	Slotted Line	1	220.00	220.00
874-P	Panel Connector	2	2.90	5.80
874-QNJ	Adaptor to TYPE N Jack	1	3.75	3.75
874-QNP	Adaptor to TYPE N Plug	1	4.50	4.50
874-R20	Flexible Line (Patch Cord)	2	6.50	13.00
874-R34	Patch Cord	1	5.50	5.50
874-T	Tee	1	9.00	9.00
874-WM	Matched (50 ohm) Termination	1	15.00	15.00
874-WN	Short-Circuit Termination	1	2.50	2.50
874-WO	Open-Circuit Termination	1	1.75	1.75
874-Z	Stand	1	17.50	17.50
TOTAL	TYPE 874-EK Basic Coaxial Kit			\$361.05

KITS FOR THE MEASUREMENT OF CABLE CHARACTERISTICS

The TYPE 874 Coaxial Elements used in conjunction with General Radio Unit Instruments and associated equipment are very well suited to the measurement of the attenuation, characteristic impedance, velocity of propagation, and capacitance of both coaxial and twin-conductor cables. For convenience in ordering, the necessary equipment is available in combinations for specific types of measurement.

These kits and their use are described in Reprint No. E-104, entitled "The Measurement of Cable Characteristics". Write for a copy.





Balun with tuning elements and stand (not included in price).

TYPE 874-UB BALUN AND ACCESSORIES

USES: The TYPE 874-UB Balun is a tuned, coaxial transformer that makes possible measurements on balanced devices with generally available coaxial and grounded measuring equipment. With the TYPE 874-LBA Slotted Line or the TYPE 1602-B Admittance Meter, it permits balanced measurements on 200-ohm balanced components from 54 to 1000 Mc without appreciable insertion loss or transformation error. With the Admittance Meter and the TYPE 874-LK Constant-Impedance Adjustable Line, the Admittance Meter will read balanced impedance directly. With the 874-UB-P3 300-ohm Terminal Pad, the 50-ohm coaxial output from a signal generator such as the TYPE 1021-A can be converted into a 300-ohm balanced output, or a 50-ohm coaxial load (or detector) can be converted into a 300-ohm load to provide a matched termination to a 300-ohm line.

DESCRIPTION: The balun makes the balanced-to-unbalanced conversion accurately by using a tunable artificial (or loaded) half-wave line. It is adjusted for proper operation at a particular frequency by means of shunt tuning elements as listed below. These elements are not supplied with the TYPE 874-UB Balun but should be ordered separately.

SPECIFICATIONS

Frequency Range: 54 to 1000 Mc with proper accessories as listed at right.

Accessories Supplied: One TYPE 874-UB-P1 300-Ω Terminal; one TYPE 874-WN3 Short-Circuit Termination; one TYPE 874-WO3 Open-Circuit Termination.

Other Accessories Recommended: One TYPE 874-LK20 Constant-Impedance Adjustable Line (for use with the TYPE 1602-B Admittance Meter), one TYPE 874-Z Stand, appropriate tuning elements and accessories as listed at right.

Tuning Elements Required for Various Frequency Ranges:

Frequency Range	Accessory Equipment
470 to 1000 Mc	2-TYPE 874-D20
350 to 525 Mc	2-TYPE 874-D20 and 2-TYPE 874-L10
275 to 380 Mc	2-TYPE 874-D20 and 2-TYPE 874-L20
225 to 280 Mc	2-TYPE 874-D20 and 2-TYPE 874-L30
170 to 280 Mc	2-TYPE 874-D50 and 2-TYPE 874-L30
174 to 216 Mc	2-TYPE 874-VC and 2-TYPE 874-L10
140 to 174 Mc	2-TYPE 874-VC and 2-TYPE 874-L20
88 to 140 Mc	2-TYPE 874-VC and 2-TYPE 874-L30
54 to 88 Mc	2-TYPE 874-VC and 2-TYPE 874-XL

Type		Code Word	Price
874-UB	Balun	COAXYBALUN	\$75.00
874-D20	Adjustable Stub (20 cm.)	COAXTUBBER	14.00
874-D50	Adjustable Stub (50 cm.)	COAXBIGGER	14.00
874-L10	50-Ω Air Line (10 cm.)	COAXDECKER	5.50
874-L20	50-Ω Air Line (20 cm.)	COAXVENTER	6.00
874-L30	50-Ω Air Line (30 cm.)	COAXTRIPLY	6.50
874-VC	Variable Capacitor	COAXYFARAD	50.00
874-XL	Series Inductor	COAXDUCTOR	11.00
874-UB-P4	Adaptor (Balun to Twinax Connector)	COAXTWINNY	50.00



**Type 874-UB-P2
200-Ohm
Terminal Unit**

Connects the balun to a balanced network whose impedance is to be measured at its own terminals. The 4:1 impedance transformation in the balun converts the 200-ohm balanced line to a 50-ohm coaxial line, hence the

200-ohm balanced line can be treated as an extension of the 50-ohm line of the measuring device.

Characteristic Impedance: 200 ohms.

Frequency Range: d-c to 1000 Mc.

Recommended Transmission Line: RG-86/U.

VSWR: <1.2 to 300 Mc; <1.3 to 1000 Mc.

Type	Code Word	Net Weight	Price
874-UB-P2	COAXTERMER	1 ounce	\$6.50

Type 874-UB-P3 300-Ohm Terminal Pad

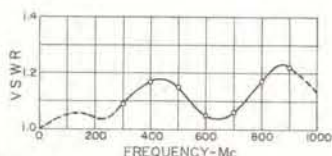

Converts to 300 ohms the 200-ohm balanced output impedance produced from a 50-ohm unbalanced source by the balun. This pad facilitates power and voltage measurements on balanced systems, with signal generators, detectors, etc., designed for use with 50-ohm coaxial circuits.

Type 874-BM 300-Ohm Balanced Termination

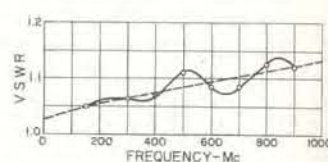

A useful element to facilitate balanced line measurements.

D-C Resistance: 300 ohms ± 5%

Frequency Range: 0-1000 Mc.

VSWR: <1.2 to 900 Mc.

Type	Code Word	Net Weight	Price
874-UB-P3	COAXTUGGER	2 ounces	\$15.00
874-BM	COAXLOADER	1½ ounces	\$9.00





FILTERS

Type 874-F Low-Pass Filters

Reduction of harmonics from a uhf generator by filters is usually necessary for best measurement results, particularly if a system contains voltmeters, non-linear elements, or sections that might resonate at a harmonic frequency, or if high standing-wave ratios are to be meas-



ured using a slotted line. These filters are of the Tschelysheff type.

Accuracy of Cut-off Frequencies: -0% , $+10\%$.

Type		Net Weight	Physical Length	Code Word	Price
874-F185	185 Mc Low Pass Filter...	14 oz.	17 $\frac{7}{8}$ in.	COAXRUFFER	\$25.50
874-F500	500 Mc Low Pass Filter...	8 oz.	10 $\frac{3}{16}$ in.	COAXDIPPER	16.00
874-F1000	1000 Mc Low Pass Filter..	6 oz.	7 $\frac{1}{2}$ in.	COAXMEGGER	14.00
874-F2000	2000 Mc Low Pass Filter..	5 oz.	4 $\frac{3}{8}$ in.	COAXPUSHER	14.00
874-F4000	4000 Mc Low Pass Filter..	4 oz.	2 $\frac{7}{8}$ in.	COAXLENDER	14.00

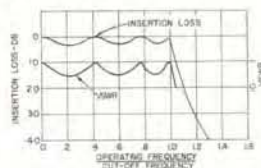

Type 874-FR1, -FR2, -FR3 Rejection Filters

These rejection filters are specifically intended for use with other General Radio equipment in the measurement of harmonics of vhf television transmitters in accordance with FCC specifications. A booklet describing the measurement procedure is available on request. Each filter consists of a simple, series-resonant L-C circuit in shunt with a short section of 50-ohm coaxial line. The capacitor is adjustable (screwdriver setting) to vary the resonant frequency. A pair of units must be used for TV transmitter harmonic measurement, hence they are priced in pairs in the table below:

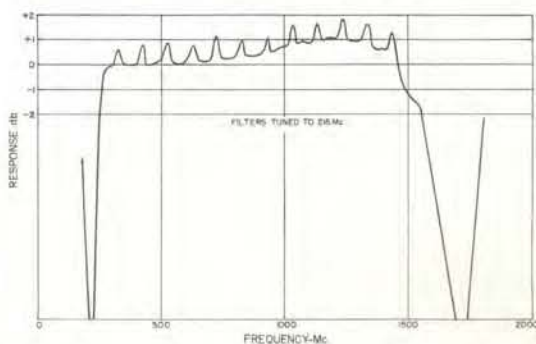

Response curve of a pair of TYPE 874-FR3 Rejection Filters with the TYPE 874-MR Mixer Rectifier.

Type	For TV Channel	Min. Fund. Rej. of Pair	Tuning Range	Upper Freq. Limit of Flat Pass Band	Net Weight	Code Word	Price
874-FR1	2, 3, 4	60 db	54-90 Mc	740 Mc	10 oz.	COAXROUTER	\$70.00/pair
874-FR2	5, 6	60 db	76-135 Mc	900 Mc	10 oz.	COAXRINGER	70.00/pair
874-FR3	7 thru 13	60 db	130-216 Mc	1300 Mc	10 oz.	COAXROCKER	70.00/pair

TYPE 874-MR MIXER RECTIFIER

DESCRIPTION: The Mixer Rectifier is used as a frequency converter, and in combination with the TYPE 1216-A Unit I-F Amplifier* it forms a universal uhf-vhf heterodyne detector for the laboratory. The high-frequency signal is mixed with a signal from a local oscillator (fundamental or harmonic) to produce a difference frequency of 30 Mc, which is then fed to the i-f amplifier. The 250-ohm series resistor isolates the signal circuit from the local-oscillator circuit.

*Other i-f amplifiers or receivers operating at frequencies between 0 and 40 Mc can also be used.

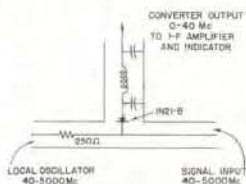

SPECIFICATIONS

Operating Frequency Range: 40 to 5000 Mc, and at lower and higher frequencies with decreased sensitivity.

Maximum Crystal Current: 25 ma.

Maximum Input from Local Oscillator: 2 volts.

Cut-Off Frequency of Output Filter: 40 Mc.

Conversion Loss at 30-Mc Output: About 6 db with the TYPE 1216-A Unit I-F Amplifier when local-oscillator fundamental is used.

Accessories Required: Local oscillator for heterodyning (Unit Oscillators are recommended). Patch cords are needed for connections. For complete detector assembly, see page 65.
Net Weight: 5 ounces.

Type		Code Word	Price
874-MR	Mixer Rectifier.....	COAXVERTER	\$32.50





COAXIAL VOLTMETERS

The Voltmeter Detector (TYPE 874-VQ) and the Voltmeter Rectifier (TYPE 874-VR) are used for measuring and monitoring voltage in 50-ohm coaxial lines. The diagrams below indicate the differences between the two instruments. The VQ-type is used either as a monitoring voltmeter or a terminating voltmeter or detector, while the VR-type is intended for indicating the voltage behind 50 ohms, as, for instance, in simulating a 50-ohm constant-voltage generator. Both types can be used with the Voltmeter Indicator (see below).



SPECIFICATIONS (BOTH TYPES)

Maximum Voltage: 2 volts
Resonant Frequency: Approximately 5400 Mc; correction curve supplied.
Crystal: 1N23B

By-Pass Capacitance: Approximately 300 $\mu\mu\text{f}$.
Dimensions: (Length) $3\frac{3}{4}$ x (height) $2\frac{1}{2}$ inches.
Net Weight: 5 ounces.

Type 874-VQ Voltmeter Detector

The Voltmeter Detector can be used with the Voltmeter Indicator for voltage measurement, with an audio amplifier as a sensitive detector of modulated signals, and with a microammeter as an r-f detector. It introduces no appreciable discontinuity when inserted in a 50-ohm coaxial line. With the TYPE 874-WM 50-ohm termination, it can be used as a matched detector to terminate a line.
Frequency Range as Matched Detector: 0.5 to 2000 Mc. Usable from 60 c to 5000 Mc.
VSWR: <1.1 at 1000 Mc, 1.2 at 2000 Mc.

Type 874-VR Voltmeter Rectifier

The Voltmeter Rectifier, in conjunction with the Voltmeter Indicator, will measure or monitor the voltage in coaxial systems. It can, for instance, be used to convert a well-shielded oscillator to a standard-signal generator. It is also useful as a general-purpose detector.
Frequency Range for Voltage Measurements: 15 Mc to 2500 Mc, subject to resonance correction above 500 Mc. Voltage indications and correct voltage ratios can be obtained at both lower and higher frequencies. See curve.

Type	Code Word	Price
874-VQ Voltmeter-Detector	COAXVOQUER	\$30.00

Type	Code Word	Price
874-VR Voltmeter Rectifier	COAXRECTOR	\$30.00

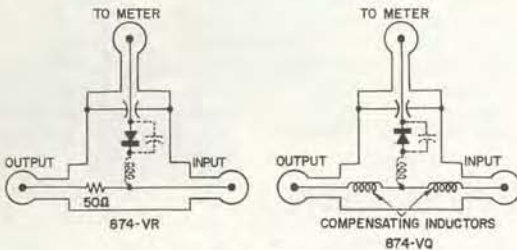

Schematics and average correction factor for TYPES 874-VR and -VQ.

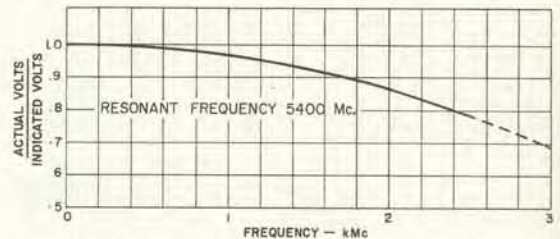

Type 874-VI Voltmeter Indicator



Indicates the rectified d-c output of either the TYPE 874-VR or TYPE 874-VQ and provides means for measuring the voltage at any level between 0.1 volt and 2 volts. A built-in 60-cycle calibration system eliminates errors arising from differences in crystal rectification efficiencies.
Range and Accuracy of Calibrating Voltage: 0.1-2 volts \pm 0.05 volts.

Crystal Current for Full-Scale Indication: 200 μa .
Power Supply: 105 to 125 volts, 50 to 60 cycles.
Input Resistance: 600 ohms, minimum; 10,000 ohms, maximum.

Accessories Supplied: TYPE CAP-35 Power Cord.
Other Accessories Required: Order one TYPE 874-R34 Patch Cord to connect rectifier to indicator.

Dimensions: $5\frac{1}{2}$ x $5\frac{1}{2}$ x $4\frac{1}{2}$ inches, over-all.
Net Weight: 3 pounds, 1 ounce.

Type	Code Word	Price
874-VI Voltmeter Indicator	COAXVOLTER	\$80.00
874-R34 Patch Cord	COAXFITTER	5.50





LINE STRETCHERS AND RIGID AIR LINES

Type 874-LT Trombone Constant-Impedance Adjustable Line



With this line stretcher, built like a trombone slide, the length of a 50-ohm transmission line between two fixed terminals can be varied without moving either terminal or using flexible cable. Consists of two 874-LK20's mounted parallel to one another and joined at one end by a U-shaped section to form a rigid assembly. Can be plugged into two adjacent TYPE 874 Coaxial Connectors or inserted in a line by means of two ells (not included). This saves space when line is used vertically. Low VSWR. An excellent phasing unit.

Characteristic Impedance: 50 ohms.
Frequency Range: D-C to 2000 Mc.
Adjustment Range: 44 cm (half wave at 340 Mc).
Physical Length: 61 cm (min.) to 83 cm. (max.)
Spacing: 1 $\frac{3}{16}$ inches between centers.
VSWR: Less than 1.10 to 1000 Mc, and 1.25 to 2000 Mc.
Net Weight: 2 pounds.

Type	Code Word	Price
874-LT Constant-Impedance Line	COAXTROMBO	\$85.00

Type 874-LK Constant-Impedance Adjustable Lines



A line stretcher with a very low VSWR and a uniform characteristic impedance of 50 ohms. A locking mechanism is provided. Particularly useful for eliminating the usual Smith-chart corrections for the length of line between the unknown and the impedance-measuring device by adjustment of the overall line length to a multiple of one-half wavelength. The TYPE 1602-B Admittance Meter can be made to read directly in impedance by adjustment of the overall line length to an odd multiple of a quarter wavelength. This line is also useful as an

impedance-matching transformer in coaxial systems.
Impedance: 50 ohms.
Length: TYPE 874-LK20 Adjustable from 58 to 80 cm. (half-wave at 680 Mc); TYPE 874-LK10, Adjustable from 35 to 45 cm (half-wave at 1500 Mc).
VSWR: TYPE 874-LK20 Less than 1.03 at 500 Mc, 1.06 at 1000 Mc, 1.08 at 1500 Mc, and 1.10 at 2000 Mc.; TYPE 874-LK10, same up to 2000 Mc, less than 1.15 at 3000 Mc, 1.2 at 4000 Mc, 1.25 at 5000 Mc.
Net Weight: 874-LK20 14 ounces; 874-LK10, 10 ounces.

Type	Code Word	Price
874-LK20 Constant-Impedance Adjustable Line (22 cm)	COAXKEEPER	\$36.00
874-LK10 Constant-Impedance Adjustable Line (10 cm)	COAXKENTER	33.00

Type 874-LA Adjustable Line

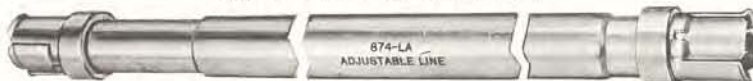

An air-dielectric, coaxial line that can be telescoped to change its length. Used in matching networks. Contacts are made by multiple spring fingers.
Characteristic Impedance: Not constant—approximately 50 ohms when fully collapsed. Approximately 57 ohms when fully extended.

Length: From 33 to 58 cm.
Net Weight: 10 ounces.

Type	Code Word	Price
874-LA Adjustable Line	COAXLAPPER	\$17.50

50-Ohm Rigid Air Lines



For spacing stubs or other elements of a coaxial system. Each air line consists of a length of 50-ohm, air-dielectric, coaxial line with a TYPE 874 Coaxial Connector at each end.

Type	Net Weight	Code Word	Price
874-L10 10 cm.	2 oz.	COAXDECKER	\$5.50
874-L20 20 cm.	4 oz.	COAXVENTER	6.00
874-L30 30 cm.	6 oz.	COAXTRIPLY	6.50





TERMINATIONS

Type 874-WM 50-ohm Termination

A 50-ohm cylindrical resistor mounted in a tapered coaxial holder, for impedance matching, establishing reference conditions, and terminating filters and attenuators.

D-C Resistance: 50 ohms \pm 1%

Max. Continuous Power: 1/2 watt

Max. Peak Power: 500 watts

VSWR: Less than 1.08 to 2000 Mc; less than 1.13 to 4000 Mc.



Type	Code Word	Net Weight	Price
874-WM	COAXMETER	2 1/2 ounces	\$15.00

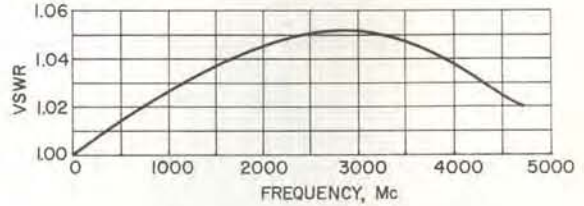

VSWR of TYPE 874-WM 50-ohm Termination

Type 874-W100 100-ohm Coaxial Standard

Produces known resistive termination at specific locations on coaxial lines for checking detector linearity, accuracy of directional couplers, bridges and admittance meters. The known location of the pure resistive termination makes possible the production of many known complex impedances through additions of sections of TYPE 874-L Air Line.

D-C Resistance: 100 ohms \pm 1%

Max. Continuous Power: 1/3 watt

Max. Peak Power: 150 watts

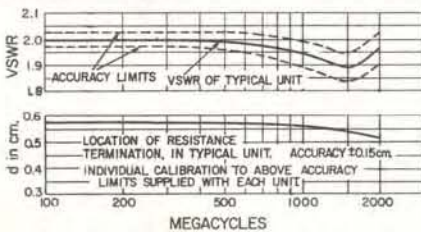

Type 874-W200 200-ohm Coaxial Standard

Same as TYPE 874-W100 except 200-ohm termination.

D-C Resistance: 200 ohms \pm 1%

Max. Continuous Power: 1/4 watt

Max. Peak Power: 50 watts

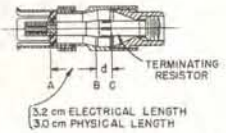

Type	Code Word	Net Weight	Price
874-W100	COAXCENTER	3 ounces	\$32.50
874-W200	COAXILTER	3 ounces	32.50

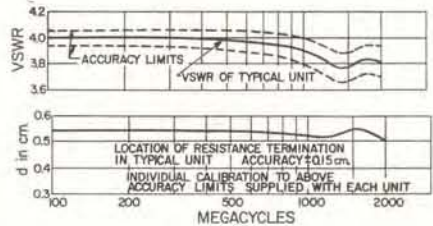

Plot of VSWR and position of pure resistance termination for (left) TYPE 874-W100 and (right) TYPE 874-W200. Distance, *d*, (see sketch above) is the distance from the position of the short or open circuit produced by a TYPE 874-WN3 or TYPE 874-WO3 to the position of the pure resistance termination.

Type 874-WO Open-Circuit Termination

A shielding cap for open-circuited lines, for establishing reference condition on coaxial lines and for use in substitution methods. Produces an open circuit at same point in line that TYPE 874-WN produces a short.

Type 874-WO3 Open-Circuit Termination

Same as TYPE 874-WO except for position of open circuit, which is same as for TYPE 874-WN3.

Type	Code Word	Net Weight	Price
874-WO	COAXOPENER	2 ounces	\$1.75
874-WO3	COAXYTRIPO	2 ounces	3.00

Cross section of (left) TYPE 874-WO3 and (right) TYPE 874-WN3.

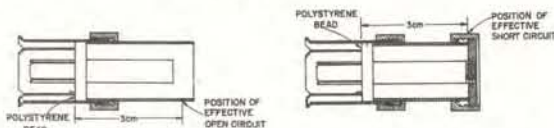

Type 874-WN Short-Circuit Termination

A fixed shorting strap mounted in a connector, for establishing reference conditions on coaxial lines and for use in substitution measurements.



TYPE 874-WO

TYPE 874-WN

Type 874-WN3 Short-Circuit Termination

Same as TYPE 874-WN except the short circuit is presented at a point 3 cm (3.2 cm. electrical distance) beyond the face of the bead in the TYPE 874 Connectors. This distance corresponds to the distance between the bead and ground plane of the 874-M Component Mount and the distance between the bead and the unbalanced terminal in the TYPE 874-UB Balun.

Type	Code Word	Net Weight	Price
874-WN	COAXNULLER	2 ounces	\$2.50
874-WN3	COAXYTRINU	2 ounces	4.25





STUBS, TUNING, AND COUPLING ELEMENTS

Type 874-D20 and D50 Adjustable Stubs



For matching or tuning, and use as reactive elements. Can be used with indicator and scale as reaction-type wavemeters. Consists of a coaxial line with a sliding short circuit of the multiple spring-finger type. The 20-cm stub is calibrated in electrical length from the

junction of the branch line with the through line in a TYPE 874-T. The 50-cm stub has no calibration but has an adjustable reference marker.

Characteristic Impedance: 50 ohms

Maximum Travel of Short Circuit: 20 cm for 874-D20
50 cm for 874-D50

Type		Net Weight	Code Word	Price
874-D20	Adjustable Stub (20 cm)	6 oz.	COAXTUBBER	\$14.00
874-D50	Adjustable Stub (50 cm)	10 oz.	COAXBIGGER	14.00



Type 874-VC Variable Capacitor

Tuning element for resonant-line circuits, matching transformers, and baluns at low frequencies where line-type elements are awkward to use. Well-shielded, high-temperature polystyrene insulation, and precision ball bearings.

Scale: 0-100

Capacitance Variation: Linear

Capacitance Range: High frequencies, see curve; Low frequencies, 14 to 70 μf at connector. 16.5 to 72.5 μf at T-junction.

Dimensions: 2 1/2" diameter x 5 1/4" high **Net Weight:** 12 ounces

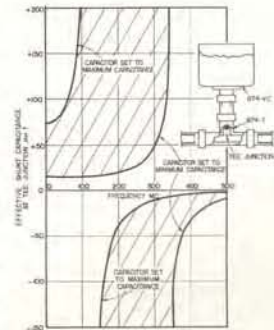

Type	Code Word	Price
874-VC Variable Capacitor ..	COAXYFARAD	\$50.00

Type 874-XL Series Inductor



Used as a general-purpose tuning element in resonant-line circuits, matching transformers, and baluns at low frequencies. **Series Inductance:** 0.226 μh $\pm 5\%$ at 1 kc.

Type	Code Word	Price
874-XL Series Inductor	COAXDUCTOR	\$11.00



Type 874-LR Radiating Line

Allows coupling to the fields within a coaxial system. Short coaxial line with opening in outer conductor that can be partially or completely covered by a rotatable sleeve.

VSWR: Closed, less than 1.05 at 1000 Mc, less than 1.4 at 3000 Mc, and less than 1.35 at 4000 Mc.

Net Weight: 4 ounces.

Type 874-K Coupling Capacitor

A short length of coaxial line having a cylindrical capacitor in series with the inner conductor. High frequencies are transmitted with small reflections, but d-c and low audio frequencies are blocked.

Coupling Capacitance: 4700 μf -20% $+50\%$

VSWR: Less than 1.06 at 1000 Mc; 1.2 at 2000 Mc.

Voltage Rating: 500 volts

Length: 3 1/16 inches

Net Weight: 3 ounces



Type 874-MB Coupling Probe

Electrostatic probe consisting of a binding post mounted on a TYPE 874 Coaxial connector.

Physical Length Over-all: 3 inches

Net Weight: 3 ounces



Type 874-T

For connecting stubs and other elements in shunt with a coaxial line.

Net Weight: 3 ounces.



Type 874-EL 90° ELL

Characteristic Impedance: 50 ohms

Electrical Length: Approximately 7 cm

VSWR: Less than 1.06 at 2000 Mc;

less than 1.15 at 4000 Mc.

Net Weight: 3 ounces



Type 874-JR Rotary Joint

Used when one part of a system must be rotated with respect to another part. Not for motor-driven applications.

VSWR: Less than 1.05 at 1000 Mc; less than 1.3 at 4000 Mc.



Type	Code Word	Price
874-T Tee	COAXTOGGER	\$ 9.00
874-EL 90° Ell	COAXANGLER	7.50
874-JR Rotary Joint	COAXJOINER	10.00
874-LR Radiating Line	COAXMITTER	8.50
874-K Coupling Capacitor ..	COAXKICKER	8.50
874-MB Coupling Probe	COAXPROBER	3.25





ATTENUATORS

Type 874-GA Adjustable Attenuator

A mutual-inductance (waveguide-below-cutoff) type of attenuator, useful for producing known voltage ratios, for measuring attenuation, and for adjusting voltage magnitude. Consists of a loop that can be positioned longitudinally within a hollow tube by rotating an outside sleeve. One turn of the sleeve produces a 20-db change in attenuation. Sleeve and tube are calibrated directly in decibels of relative attenuation on a micrometer-type scale. The absolute attenuation is the sum of the insertion loss and the reading of the attenuator. The input system is a short coaxial line with a connector at each end, one end for connection to the power source and the other for connection to a 50-ohm termination, an adjustable stub, or any desired load. The output of the loop is brought out through three feet of double-shielded 50-ohm flexible cable, which is approximately matched at the loop end by a 50-ohm resistor between the low side of the loop and ground.

Can be used in conjunction with TYPE 874-VR Voltmeter Rectifier and TYPE 874-VI Voltmeter Indicator to convert a GR Unit Oscillator into a signal generator. **Calibrated Range:** 120 db (relative attenuation) with input line terminated in 50 ohms; 129 db with input line terminated in adjustable stub to minimize the electrical field at the coupling point. (Scale reads -9 to 120 db) Usable range depends upon shielding between input and output.

Insertion Loss: (from input connector to end of output cable at 1000 Mc, when signal source impedance is 50 ohms)

With input line terminated in 50 ohms, and scale set at 0 db, 33 ± 2 db; with scale set at -9 db, 18 ± 2 db; but range from -9 to 0 is not accurate.

With input line terminated in adjustable stub (which extends the range over which calibration is accurate), and scale set at -9 db, 20 ± 2 db.

Insertion loss is approximately inversely proportional to frequency up to 1000 Mc.

Insertion Loss Directly Through Tee: Negligible

Accuracy of Attenuation:

Stub-terminated input, ±(1% of difference in attenuation readings +0.2) db, direct reading.

50-ohm terminated input, ±(1½% of difference in

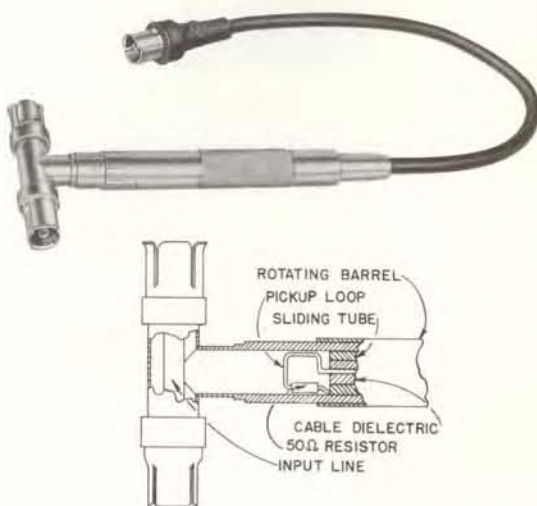

Cross section of the coupling system used in the TYPE 874-GA Adjustable Attenuator.

attenuation readings +0.2) db, when corrected. Correction chart supplied.

Cutoff Frequency: 12,300 Mc.

VSWR Introduced into Line: Less than 1.03 at 1000 Mc.; less than 1.2 between 1000 and 4000 Mc.

VSWR of Output: Less than 4 at 1000 Mc.

Less than 5 up to 4000 Mc.

Maximum Permissible Power: Maximum power in input line is inversely proportional to the square root of frequency and should not exceed 150 watts at 1000 Mc; output power should not exceed ½ watt.

Frequency Range: 100 Mc to 4000 Mc.

Net Weight: 1¼ pounds.

Type	Code Word	Price
874-GA Adjustable Attenuator	COAXLOSSER	\$55.00

Physical Length: 3½ inches overall

Net Weight: 2 ounces

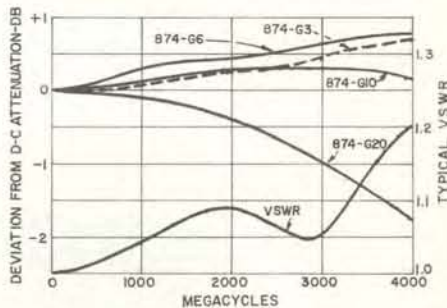

Fixed Attenuators

A single section, T-type resistance pad. Useful for adding fixed known attenuation in 50-ohm systems and for matching generators or loads to 50 ohms. Consists of one disk resistor and two cylindrical resistors, as shunt and series elements respectively.

D-C Resistance: 50 ohms ± 1% when terminated in 50 ohms. **VSWR:** Less than 1.1 to 1000 Mc. 1.2 to 3000 Mc for all units; to 4000 Mc, less than 1.3 for -G20, 1.35 for -G10, and 1.4 for -G3 and -G6.

Accuracy of Attenuation in 50-ohm System: ± 1.5% of nominal attenuation at dc; ± 0.2 db from value indicated on curve to 1000 Mc; ± 0.4 db to 2000 Mc; ± 0.6 db to 4000 Mc.

Temperature Coefficient: less than 0.0003 db/°C/db

Maximum Continuous Power Input: 1 watt

Maximum Peak Power Input: 3000 watts

Type	Code Word	Price
874-G3 Fixed Attenuator (3 db)	COAXFULLER	\$36.00
874-G6 Fixed Attenuator (6 db)	COAXNODDER	30.00
874-G10 Fixed Attenuator (10 db)	COAXBELLER	30.00
874-G20 Fixed Attenuator (20 db)	COAXNEPPER	30.00





MISCELLANEOUS

Type 874-M Component Mount

The TYPE 874-M Component Mount is a shielded enclosure with convenient inside terminals for mounting small components to be measured. It minimizes "lead" reactance and stray capacitance when the impedance of circuit elements and networks is measured over a frequency range from dc to 5000 Mc.

The Component Mount connects directly to the TYPE 874-LBA Slotted Line, the TYPE 1602-B Admittance Meter, the TYPE 874-LK Constant-Impedance Adjustable Lines, and all GR Coaxial Elements.

The Short- and Open-Circuit Terminations supplied simplify determination of line-length corrections between the instrument measuring point and the component being measured, without disconnection of the component from the Mount.

SPECIFICATIONS

Frequency Range: DC to 5000 Mc.

Accessories Supplied: One TYPE 874-WN3 Short-Circuit, one TYPE 874-WO3 Open-Circuit Terminations.

Other Accessories Recommended: One TYPE 874-LK20 Constant-Impedance Adjustable Line when the Mount is used with the TYPE 1602-B Admittance Meter.



Terminal: TYPE 874 Coaxial Connector.

Dimensions: Diameter, 3 inches. Height of shield can, 2 5/8 inches. **Net Weight:** 8 ounces.

Type	Code Word	Price
874-M Component Mount	COAXY MOUNT	\$25.00

Type 874-X Insertion Unit

This unit is a hollow cylinder fitted with TYPE 874 Connectors at each end. Its cover sleeve slides back to allow access to a region inside of about 2 inches in length and 9/16 inch in diameter. In this space between the TYPE 874 Connectors, almost any arbitrary arrangement of small components, such as resistors, capacitors, or inductors, can be mounted. The insertion unit can be used as a shielded housing for impedance-matching networks, attenuator pads, vhf transformers, filters, and a variety of other networks. It offers good shielding, minimum discontinuity in the line, and convenience.

Net Weight: 4 ounces.



Type	Code Word	Price
874-X Insertion Unit	COAXHOPPER	\$9.00

Type 874-Y Cliplock

A spring which can be conveniently slipped over TYPE 874 Connectors after they are engaged to provide a secure lock, preventing accidental disconnection or slippage.

Net Weight for 10: 1 ounce.



Type	Code Word	Price
874-Y Cliplock	COAXLOCKER	10* for \$2.00

*Minimum quantity sold.

Type 874-Z Stand

Provides firm support for the parts of a wide variety of coaxial systems. Consists of a heavy cast-iron base with rubber feet, 22-inch and 8-inch stainless steel rods, and three universal clamps. The vertical rod can be used to hold long tuning stubs. The horizontal rod can be moved longitudinally or interchanged with the vertical rod to provide support where needed. Two bases can be used with one 22-inch rod between them to support a long horizontal run of coaxial parts. Clamps will fit a range of diameters and will hold between two rods of different diameters. Any desired arrangement can be set up quickly. Base can be screwed down to table top for permanent setups.

Net Weight: 5 1/2 pounds.



Type	Code Word	Price
874-Z Stand	COAXHELPER	\$17.50
874-ZC Extra Clamp	COAXYCLAMP	2.25





CABLE

Type	Description	Code Word	Price
874-A2	<p>COAXIAL CABLE</p> <p>Flexible double-shielded bulk cable for permanent or semi-permanent installations and for making long patch cords. Consists of a No. 14 stranded inner conductor separated from the two braided tinned-copper shields by 0.244" O.D. polyethylene insulation, and an outer polyvinyl-chloride jacket 0.365" O.D.</p> <p>Characteristic Impedance: 50 ohms \pm 5%.</p> <p>Nominal Capacitance: 32 μf per foot.</p> <p>Attenuation: at 100 Mc about 2.6 db per 100 feet; at 1000 Mc about 10.5 db per 100 feet.</p> <p>Net Weight for 25 feet: 2$\frac{3}{4}$ pounds.</p>	COAXCUTTER	<p>\$0.50/foot</p> <p>0.27/foot*</p> <p>*In lengths of 25 feet or more.</p>
874-A3	<p>COAXIAL CABLE</p> <p>Same as above except inner conductor is 19 strands of 0.0066 inch tinned soft copper wire, separated from the two, braided shields by 0.116" O.D. polyethylene insulation, and an outer polyvinyl chloride jacket 0.206" O.D. More flexible than TYPE 874-A2, but losses are higher.</p> <p>Characteristic Impedance: 50 ohms \pm 5%.</p> <p>Nominal Capacitance: 32 μf per foot.</p> <p>Attenuation: at 100 Mc about 5.3 db per 100 feet; at 1000 Mc about 22.0 db per 100 feet; at 3000 Mc about 45.0 db per 100 feet.</p> <p>Net Weight for 25 feet: 1 pound.</p>	COAXGABBER	<p>\$0.35/foot</p> <p>0.20/foot*</p> <p>*In lengths of 25 feet or more.</p>
874-R20	<p>FLEXIBLE LINE (PATCH CORD)</p> <p>For making shielded connections where maximum shielding and minimum loss are desired. Consists of three feet of 874-A2 Polyethylene Cable (specifications above) with a TYPE 874-C Connector on each end.</p> <p>Net Weight: 7 ounces.</p>	COAXHATTER	\$6.50
874-R22	<p>PATCH CORD</p> <p>Consists of three feet of 874-A3 Coaxial Cable (specifications above) with a TYPE 874-C58 Cable Connector on each end. Recommended for use where both maximum shielding and a high degree of flexibility are needed.</p> <p>Net Weight: 4 ounces.</p>	COAXFANNER	\$6.00
874-R34	<p>PATCH CORD</p> <p>Consists of three feet of flexible, single-shielded coaxial cable with a nominal characteristic impedance of 50 ohms. It has one end terminated in a TYPE 274-NK Shielded Double Plug and the other in a TYPE 874-C58 Coaxial Connector.</p> <p>Net Weight: 4 ounces.</p>	COAXFITTER	\$5.50
874-R33	<p>PATCH CORD</p> <p>Similar to TYPE 874-R34, but with end terminated in single TYPE 274 Plugs rather than in TYPE 274-NK.</p> <p>Net Weight: 4 ounces.</p>	COAXLINKER	\$5.00



TYPE 874-A2 or -A3



TYPE 874-R20



TYPE 874-R33



TYPE 874-R22



TYPE 874-R34





CONNECTORS

All TYPE 874 Connectors are supplied unassembled with complete assembly instructions. No special tools are needed.

Type 874-B Basic Connector

For use on rigid, 50-ohm, air-dielectric, coaxial lines. Consists of inner and outer conductors, insulating bead coupling nut and retaining ring. Fits lines made from $\frac{5}{8}$ -inch O.D., $\frac{1}{16}$ -inch I.D. tubing, and 0.244-inch D rod. The inner conductor is to be screwed into an 8-32 tapped hole in the end of the rod, and the retaining ring for the coupling nut is to be snapped into a $\frac{1}{4}$ -inch deep, 0.035-inch-wide groove cut in the $\frac{5}{8}$ -inch tubing.

Net Weight: 1 ounce.

Type	Fits	Code Word	Price
874-B	Basic Connector	COAXBRIDGE	\$1.25

Cable Connector

Consists of the basic connector parts plus inner and outer transition pieces, a soft copper ferrule, and a rubber guard. The transition pieces are tapered so as to maintain the 50-ohm characteristic impedance of the connector and cable throughout the change in diameters. The cable inner conductor is to be soldered to the inner transition piece, and the cable braid is attached to the outer transition piece by crimping the ferrule. The rubber guard provides strain relief and a protective handle.

Net Weight: 2 ounces.

Type	Fits	Code Word	Price
874-C	Type 874-A2 Cable	COAXCABLER	\$2.00
874-C8	Type RG-8/U Cable	COAXCORDER	2.00
874-C9	Type RG-9/U and RG-116/U Cables	COAXCAMMER	2.00
874-C58	Type 874-A3, RG-29/U, 55/U, 58/U, and 58A/U Cables	COAXCALLER	2.00
874-C62	Types RG-59/U and RG-62/U Cables (non-constant impedance)	COAXCANDOR	2.00

Panel Connector P-Type

Is similar to the cable connector except a panel adaptor and nut are supplied in place of rubber guard. The panel adaptor fits into a $\frac{1}{16}$ -inch D hole in panels from $\frac{1}{16}$ -inch to $\frac{1}{4}$ -inch thick and is designed to clamp the connector in any desired orientation.

Net Weight: 3 ounces.

Type	Fits	Code Word	Price
874-P	Type 874-A2 Cable	COAXPEGGER	\$2.90
874-P8	Type RG-8/U Cable	COAXPUTTER	2.90
874-P9	Types RG-9/U and RG-116/U Cables	COAXCOPPER	2.90
874-P58	Types 874-A3, RG-29/U, 55/U, and 58A/U Cables	COAXPANNER	2.90
874-P62	Types RG-59/U and RG-62/U Cables (non-constant impedance)	COAXPOLLER	2.90



P-TYPE Panel Connector

Maximum Input Voltage: 1.5 kilovolts.

Maximum Input Power: 150 watts at 1000 Mc. Power is inversely proportional to the square root of frequency.



TYPE 874-B Basic Connector (above) unassembled and (below) assembled at the end of a rigid air line.



Cable Connector

Panel Connector PB-Type

Flange-mounted panel connector. Requires a $\frac{1}{16}$ -inch D hole in panel of any thickness. Four number 29 holes (0.136-inch D) drilled in flange, $\frac{1}{16}$ -inch center-to-center, to accept machine screws. Panel space required is $\frac{1}{16}$ -inch x $1\frac{1}{16}$ -inch.

Net Weight: 2 ounces.

Type	Fits	Code Word	Price
874-PB	Type 874-A2 Cable	COAXAPPLER	\$2.90
874-PB8	Type RG-8/U Cable	COAXBATHER	2.90
874-PB9	Types RG-9/U and RG-116/U Cables	COAXCANKER	2.90
874-PB58	Types 874-A3, R6-29/U, 55/U, 58/U and 58A/U Cables	COAXBABATER	2.90
874-PB62	Types RG-59/U and RG-62/U Cables (non-constant impedance)	COAXBARKER	2.90



PB-TYPE Panel Connector





ADAPTORS

TO MILITARY AND OTHER CONNECTORS

The TYPE 874-Q Adaptors connect between the universal TYPE 874 Coaxial Connectors and other commonly used types. Their low standing-wave ratios assure connection with a minimum of reflection. Another important use of these adaptors is to connect between other different connector types as shown in Figure 5, page 42. By plugging together the TYPE 874 ends of the two appropriate adaptors, one can interconnect any two systems of connectors.

Typical standing-wave ratios are shown in the plot.



Type	Contains Type 874 Connector and	Fits	Net Weight	Code Word	Price
874-Q2	274 Jacks or Plugs	274 Plugs or Jacks	2 oz.	COAXTIPPER	\$ 4.25
874-QN6		274-NO	1 oz.	COAXCLOSER	1.00
874-Q7	774 Jack or Plug	774 Plug or Jack	2 oz.	COAXPASSER	4.25
874-QBJ	BNC Jack	BNC Plug	1½ oz.	COAXBIGGER	4.75
874-QBP	BNC Plug	BNC Jack	1½ oz.	COAXBUNNER	4.75
874-QCJ	C Jack	C Plug	1 oz.	COAXCOGGER	4.75
874-QCP	C Plug	C Jack	1¾ oz.	COAXCUFFER	6.25
874-QHJ	HN Jack	HN Plug	2½ oz.	COAXHAWSER	6.50
874-QHP	HN Plug	HN Jack	2½ oz.	COAXHANGER	6.50
874-QLJ	LC Jack	LC Plug	8 oz.	COAXLITTER	19.50
874-QLP	LC Plug	LC Jack	1 lb.	COAXLUGGER	30.00
874-QLTJ	LT Jack	LT Plug	4¾ oz.	COAXLAGGER	23.00
874-QLTP	LT Plug	LT Jack	7 oz.	COAXLOBBER	23.00
874-QNJ	N Jack	N Plug	1¾ oz.	COAXNAGGER	3.75
874-QNP	N Plug	N Jack	1¾ oz.	COAXNUTTER	4.50
874-QSCJ	SC Jack	SC Plug*	1¾ oz.	COAXCOSTER	9.50
874-QSCP	SC Plug	SC Jack*	1¾ oz.	COAXCASHER	9.50
874-QTNJ	TN Jack	TN Plug*	1 oz.	COAXTUNNER	8.00
874-QTNP	TN Plug	TN Jack*	1¼ oz.	COAXTUSKER	8.00
874-QUJ	UHF Jack	UHF Plug	1 oz.	COAXYUNDER	4.00
874-QUJ	UHF Plug	UHF Jack	1½ oz.	COAXYUPPER	4.25

*Sandia type

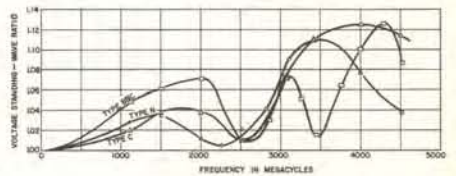
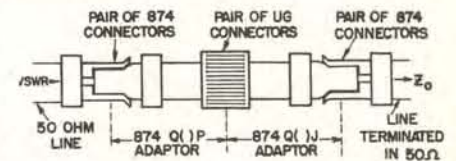

ADAPTORS TO RIGID LINE



TYPE 874-QU3A

TYPE 874-QV2A

These adaptors are used to connect the rigid lines in TV transmitting antenna systems to measuring equipment fitted with TYPE 874 Coaxial Connectors, as for instance, the TYPE 1602-B U-H-F Admittance Meter and the TYPE 874-LBA Slotted Line.

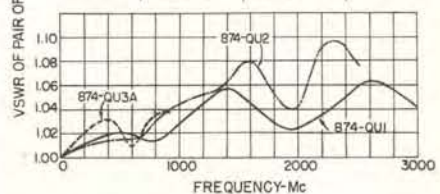
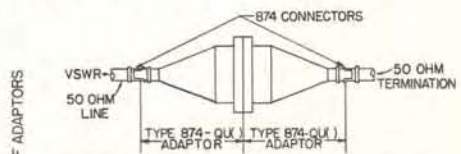

Type	Fits	EIA Std. for Line	Code Word	Net Weight	Price
874-QU1	7/8" 50-ohm UHF Rigid Line, RG-155/U	TR-134	COAXYUMBER	½ lb.	\$ 21.00
874-QU2	1 1/8" 50-ohm UHF Rigid Line, RG-153/U	TR-134	COAXYUSHER	1 ¼ lb.	75.00
874-QU3A	3 1/8" 50-ohm UHF Rigid Line, RG-154/U	TR-134	COAXYULTRA	5 ½ lb.	125.00
874-QV2A	1 1/8" 51.5-ohm VHF Rigid Line	TR-103A	COAXYVERRA	1 ¼ lb.	62.50
874-QV3	3 1/8" 51.5-ohm VHF Rigid Line	TR-103A	COAXYWAGER	5 lb.	110.00



DETECTORS AND AMPLIFIERS



▶ DETECTORS

In practically all types of electrical measurements, a means must be provided for aural or visual indication of the desired measurement condition. For bridge measurements, the indicator, or detector, must have some degree of selectivity to eliminate spurious signals, noise, and harmonics of the desired signal. For voltage amplitude measurements, a wide linear range is desirable; and in modulation measurements the output signal should be a faithful reproduction of the modulation envelope.

For these applications, a number of detectors are in common use:

1. Amplifier followed by a meter or headphones.
2. Simple rectifier to convert an a-c signal to dc or to demodulate an r-f signal.
3. Simple rectifier followed by a high-gain amplifier with an aural or visual indicator.
4. Mixer in which the signal to be measured is heterodyned with a signal of a different frequency from an oscillator and the difference



TYPE DNT Detector used with the TYPE 874-LM Dielectric Measuring Line to measure the dielectric constant and dissipation factor of solid-dielectric materials.

frequency amplified in a fixed-frequency, band-pass, high-gain amplifier.

An amplifier with meter or headphones is commonly used in the frequency range between a few cycles and several megacycles. The TYPE 1231-B Amplifier and Null Detector is an instrument of this type, for audio and somewhat higher frequencies. Selectivity can be added by the use of a filter, either the highly astatic TYPE 1951-A, or one of the TYPE 1231-P series of filters.

When used with the TYPE 1231-P4 Attenuator, the amplifier is a good standing-wave meter for the TYPE 874-LBA Slotted Line.

The TYPE 1212-A Unit Null Detector is another detector of the same general type, which covers a much wider frequency range and uses limiting amplifiers to produce a non-linear compression of the meter scale of at least 100 db, thus eliminating the need for amplifier gain adjustments during bridge balancing operations.

For maximum effective sensitivity, one of the several accessory filters should be used at the input: the TYPE 1212-P1, for eliminating pickup at the power-line frequency in measurements above 10 kc; the TYPE 1951-A, for maximum effective sensitivity and selectivity at 400 and 1000 cycles; and the TYPE 1212-P2, for maximum sensitivity and selectivity at 1 megacycle.

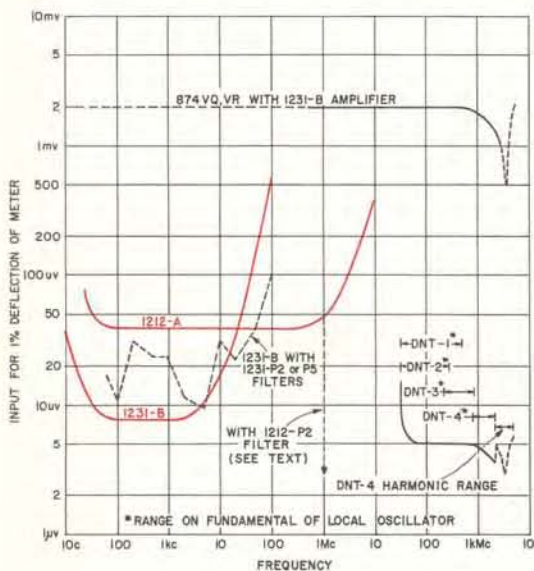

Sensitivity and frequency range of various detectors. The sensitivity figures shown for the TYPE 874-VQ and -VR Detectors are for a modulated signal (50% or more) with the amplifier tuned to the modulator frequency. At frequencies below about 500 kc an additional by-pass capacitor must be added to obtain the sensitivity indicated.





Simple rectifiers are often used at the higher frequencies. The *Type 874-VQ Voltmeter Detector* and *Type 874-VR Voltmeter Rectifier* cover a very wide frequency range, as indicated on the chart. When used directly with a meter or a telephone headset, the sensitivity is low. Used with an audio amplifier, such as the *TYPE 1231-B*, it is a sensitive detector of modulated signals.

At very-high and ultra-high frequencies, the heterodyne method of detection has many advantages. It can have high sensitivity, a wide frequency range, any amount of selectivity, and excellent linearity. In the *Type DNT Detectors*, the signal is heterodyned in a *TYPE 874-MR Mixer Rectifier* with a signal from a Unit Oscillator. The 30-Mc beat frequency is amplified and detected by a *TYPE 1216-A Unit I-F Amplifier*. Various local oscillators can be used to cover the very extensive frequency range shown in the chart, and harmonic operation can be used to extend the range of any oscillator. The 80-db linear range is also useful in relative voltage-level measurement.

Type	Class	See Page
1231-B	High-gain Voltage Amplifier	61
1212-A	Logarithmic Amplifier	63
DNT	Heterodyne with I-F Amplifier	64
874 VQ,-VR	Crystal Rectifier	50

▶ AMPLIFIERS

The General Radio Company manufactures a variety of laboratory amplifiers which meet many of the needs for amplification in research, engineering, and industry. The following amplifiers are described in this section:

1. *The Type 1231-B Amplifier and Null Detector*, which, in addition to its uses as a null detector and a standing-wave indicator, is an excellent preamplifier for use with microphones, vibration pickups and oscilloscopes. In combination with the *TYPE 874-VQ Voltmeter Detector* it becomes a sensitive detector of modulated signals at frequencies up to 5000 Mc.

2. *Type 1233-A Power Amplifier* provides several watts of power over a wide frequency range. In addition to its uses at audio and ultrasonic frequencies, it can be used as a wide-band voltage amplifier at frequencies up to 3 Mc, and, with external tuning, as a tuned amplifier up to 5 Mc.

3. *The Type 1206-B Unit Amplifier* is a high-quality general purpose, 3-watt amplifier, which operates over the audio and ultrasonic



TYPE 1206-B Amplifier used with the TYPE 1210-C Oscillator.

frequency ranges, and which has excellent, transient response. An outstanding feature of this instrument is its low-frequency response, which extends down to 2 cycles per second with a drop of only 3 db.

The combination of this amplifier and the *TYPE 1210-C Unit R-C Oscillator* comprises a compact oscillator of 3-watt output up to 100 kc and 0.4 watt up to 500 kc. This combination is pictured above.

Type	Name	See Page
1231-B	Amplifier and Null Detector	61
1233-A	Power Amplifier	67
1206-B	Unit Amplifier	68

▶ OTHER AMPLIFIERS

In addition to the amplifiers described in this section, special purpose amplifiers are described in other sections of the catalog.

DC AMPLIFIER: The *TYPE 1230-A D-C Amplifier and Electrometer* is an extremely stable instrument capable of amplifying very weak dc voltages and operating a recorder from the output.

PULSE AMPLIFIER: The *TYPE 1219-A Pulse Amplifier* will produce pulse currents up to one-half ampere from low-power pulse generators.

SOUND-LEVEL METER: The *TYPE 1551-B Sound-Level Meter* is a high-gain amplifier and logarithmic voltmeter, with a full-scale sensitivity of 20 microvolts and a range of 126 db.

Type	Name	See Page
1230-A	DC Amplifier and Electrometer	130
1219-A	Pulse Amplifier	123
1551-B	Sound-Level Meter	184





TYPE 1231-B AMPLIFIER AND NULL DETECTOR

USES: This sensitive, high-gain, voltage amplifier is used as:

- A null indicator for bridge measurements.
- A standing-wave indicator with the TYPE 874-LBA Slotted Line.
- A detector of high-frequency modulated signals when used with a TYPE 874-VQ Voltmeter Detector.
- A preamplifier for crystal microphones, vibration pickups, and other transducers, as well as for oscilloscopes.

DESCRIPTION: The amplifier consists of three stages and a vacuum-tube voltmeter. A push button on the panel of the instrument permits the output stage of the amplifier to operate either linearly for general use or logarithmically for null-detector use. The panel meter indicates relative output in two ranges, serves as a null indicator, and is used to check battery condition. Head telephones can be plugged into the output for an aural indication of the null point. A fixed 30-db attenuator can be switched into the input circuit if high input voltages are encountered.

The instrument may be ac or battery operated. Battery operation provides better overall performance, due mainly to its lower noise.



Blocking capacitors at the input and output jacks isolate the instrument from external dc.

A jack on the panel permits insertion of filters.

FEATURES:

- Simple and convenient push-button operation.
- Versatile—operates as amplifier, null indicator or VSWR meter.
- Rapid response meter with minimum overshoot for fast, accurate measurements.
- Harmonics and noise can be eliminated by available filters.

SPECIFICATIONS

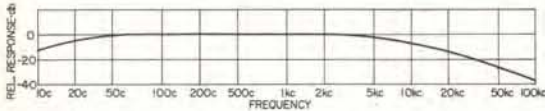

Input Impedance: 1 megohm in parallel with 20 μf; alternate 10-megohm input available.

Maximum Gain: Greater than 83 db at 1 kc with 1 megohm load.

Meter Scales: NORM scale: monitors amplifier output voltage. Calibrated in volts with accuracy of ±5% of full scale. SENS scale: indicates ratios of voltages applied to input terminals, as in standing-wave measurements. Calibrated in db with arbitrary zero, so ratio in db obtained by subtracting one meter reading from another. Ratios accurate within 30% of correct value in db, if one reading is above half scale.

Null Detector Sensitivity: Less than 25 microvolts input gives 1% indication on meter at 1 kc.

Amplifier Sensitivity: Less than 8 microvolts input at 1 kc for 1% indication on SENS range of meter.

Output Impedance: Approximately 50,000 ohms.

Maximum Output Voltage: 5 volts into 20,000 ohms; 20 volts into one megohm.

Open Circuit Noise and Hum Level: Less than 0.5 volt at full gain, battery operated; less than one volt, a-c operated with 1261-A Power Supply.

Tube Complement: Two 1L4, one 1D8-GT.

Power Supply: Burgess 6TA60 (Signal Corps BA48) is supplied unless a-c operation is specified, in which case TYPE 1261-A Power Supply (see page 145) is supplied.

Battery Life: 200 to 250 hours at 8 hours a day.

Mounting: Available for 19-inch relay rack with or without TYPE 1231-P5 Filters, battery or a-c operated, or in hardwood cabinet. See price list below.

Accessories Available: Filters (see next page); TYPE 274-NL Patch Cords for shielded input and output connections, (page 237).

Dimensions: 12¼ × 8 × 10¾ inches, over-all. Relay-rack models have 7-inch panel height.

Net Weight: Cabinet model, 23¾ pounds, including batteries; relay-rack model 14¾ pounds without filter, 24½ pounds with filter.

Type	Amplifier and Null Detector	Code Word	Price
1231-BM	Cabinet model, battery operated.....	VALID	\$260.00
1231-BMA	Cabinet model, a-c operated.....	VENUS	388.00
1231-BR	Relay-rack model, battery operated.....	VALOR	260.00
1231-BRA	Relay-rack model, a-c operated.....	VIGIL	388.00
1231-BRF	Relay-rack model, battery operated, with TYPE 1231-P5 Filter.....	VIGOR	460.00
1231-BRFA	Relay-rack model, a-c operated, with TYPE 1231-P5 Filter.....	VILLA	588.00





TYPES 1231-P2 AND 1231-P3 TUNED CIRCUITS



Parallel-tuned circuits used as interstage filters with the TYPE 1231-B for suppressing harmonics, noise, and hum in single frequency measurements. Telephone plug fits jack on the panel of the TYPE 1231-B Amplifier.

Tuning Accuracy: $\pm 2\%$ at normal voltage levels.
Attenuation: At least 25 db to second harmonic.
Dimensions: $4\frac{1}{8}$ (height) \times $3\frac{3}{16}$ (width) \times 4 (depth) inches overall. **Net Weight:** $3\frac{7}{8}$ pounds, either model.

Type	Frequency	Code Word	Price
1231-P2	400 and 1000 cycles.....	AMBLE	\$38.00
1231-P3	60 cycles	AMPLE	25.00

TYPE 1231-P5 ADJUSTABLE FILTER



capitance Bridge is direct reading. Terminals are provided for connecting an external capacitor to tune to any other frequency between 20 c and 100 kc.

Frequency Calibration: 50, 100 c, -2 $\pm 5\%$; 200 and 500 c, 1, 2, 5, 10, 20, 50, 100 kc, $\pm 2\%$ at normal voltages.
Insertion Gain: -15 to $+15$ db, depending upon frequency.
Second Harmonic Rejection: 28 to 46 db.
Terminals: Shielded cord and plug for connection to TYPE 1231. Jack-top terminals for external capacitors.
Accessories Available: TYPE 1419 Decade Capacitors (page 170) for tuning filter to other frequencies.
Mounting: Aluminum cabinet model for bench use and relay-rack model available.
Dimensions: Front panel, 7 (height) \times $6\frac{1}{8}$ (width) inches. Cabinet, $9\frac{3}{4}$ (depth) inches. Internal shield box, $6\frac{1}{4}$ (height) \times $4\frac{1}{2}$ (width) \times 9 (depth) inches.
Net Weight: 9 pounds, 12 ounces.

This parallel-resonant, shielded filter is used with amplifiers to reduce harmonics and background noise in bridge measurements. It can be set to any one of eleven fixed frequencies, including those at which the TYPE 716-C Ca-

Type	Code Word	Price
1231-P5M Adjustable Filter (Cabinet Model)	ALDER	\$215.00
1231-P5R Adjustable Filter (Relay-Rack Model)	ADOBE	215.00

TYPE 1231-P4 ADJUSTABLE ATTENUATOR



Source Impedance: 30 k Ω .
Load Impedance: At least one megohm.
Insertion Loss: 3 db.
Attenuation Range: 80 db, readable to nearest tenth db.
Attenuation Accuracy: ± 0.3 db when operated between rated source and load impedances. Additional errors caused by source impedance between 14 k Ω and 60 k Ω are less than ± 0.3 db.
Frequency Error: Negligible below 2 kc.
Maximum Input Power: $\frac{1}{2}$ watt.
Terminals: Input, TYPE 938-W Binding Posts; output, shielded cable with TYPE 274-NK Shielded Plug to fit amplifier input terminals.
Accessories Required: One TYPE 874-R34 Patch Cord for connections between slotted line and attenuator.
Dimensions: $5\frac{1}{2}$ \times $5\frac{1}{2}$ \times $4\frac{1}{2}$ inches, over-all.
Net Weight: 2 pounds, 11 ounces.

A high-impedance resistive voltage divider covering a range of 80 db, with three 20 db steps and a 20 db potentiometer. Used with the TYPE 1231-B Amplifier and Null Detector and the TYPE 874-LBA Slotted Line to measure standing-wave ratio.

Type	Code Word	Price
1231-P4 Adjustable Attenuator.....	ANNEX	\$70.00
874-R34 Patch Cord.....	COAXFITTER	5.50





TYPE 1212-A UNIT NULL DETECTOR



USES: The Unit Null Detector is primarily a balance indicator for ac bridge measurements. It is a sensitive, wide-frequency-range voltage indicator with an approximately logarithmic relation between input voltage and meter reading. This null detector with suitable input filters can be used with the TYPE 1603-A Z-Y Bridge, TYPE 716-C Capacitance Bridge, TYPE 667-A Inductance Bridge, TYPE 1661-A Vacuum-Tube Bridge, TYPE 916-AL R-F Bridge, TYPE 716-CS1 Capacitance Bridge, and up to 5 Mc with the TYPE 1606-A R-F Bridge.

DESCRIPTION: The instrument consists of a three-stage, broad-band amplifier with series-peaking compensation. Germanium-diode clip-

pers are used between stages to obtain the quasi-logarithmic input-output relationship.

FEATURES:

- 50 cycles to 5 megacycles.
- Meter zero controllable from panel to correct for amplifier or system noise.
- Regulated tube voltages and balanced meter circuit maintain high stability.
- Meter sensitivity control provided for settings of voltage range desired.
- Headphones can be used.
- Miniaturized unit construction.
- On-Scale range of approximately 120 db.
- High sensitivity.
- Sensitivity increases as balance is approached—increases speed and precision.

SPECIFICATIONS

- Sensitivity:** Less than 40 microvolts input at 1 kc is required to deflect meter one per cent of full scale.
- Voltage Response:** See curve below.
- Power Supply:** TYPE 1203-B or TYPE 1201-B Unit Power Supply is recommended.
- Frequency Response:** See curve below.
- Tube Complement:** Three 6AK5, one 12AX7, one 0A2.
- Accessories Supplied:** Power supply plug and cable con-

- necter.**
- Accessory Filters Available:** TYPES 1212-P1, for eliminating low-frequency hum and noise, 1212-P2, for use at 1 Mc, 1951-A, for maximum sensitivity and selectivity at 400 and 1000 cycles.
- Dimensions:** (Width) 9½ × (height) 5¼; (depth behind panel) 5½ inches, over-all.
- Net Weight:** 5½ pounds.

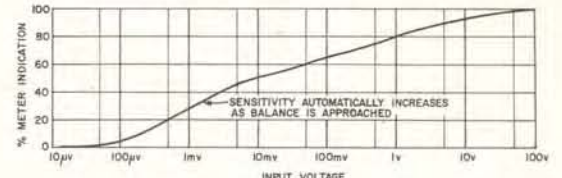
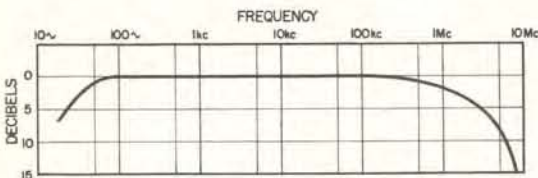

Type		Code Word	Price
1212-A*	Unit Null Detector	ALACK	\$145.00
1203-B	Unit Power Supply	ALIVE	40.00
480-P4U3	Relay-Rack Panel (for Amplifier and Power Supply) .	UNIPANCART	10.85

*PATENT NOTICE. See Note 4, page x.





TYPE 1212-P1 HIGH-PASS FILTER

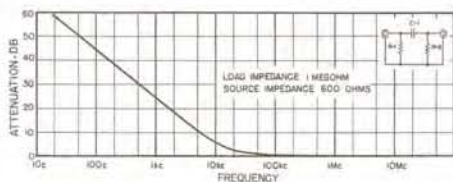

A shielded, RC high-pass filter designed to attenuate low-frequency noise and hum often encountered in bridge measurements. It provides about 50 db attenuation at 60



cycles when used in conjunction with the TYPE 1212-A Unit Null Detector and fed from a low-impedance source.
Nominal Load Impedance: 1 megohm.
Input Voltage Limit: 150 volts maximum.
Terminals: TYPE 874 Connector at each end.
Dimensions: $\frac{7}{8}$ inch diameter by $4\frac{3}{8}$ inches long.
Net Weight: 3 ounces.

Type	Code Word	Price
1212-P1 High-Pass Filter.....	UNCLE	\$12.00

PATENT NOTICE. See Note 4, page x.

TYPE 1212-P2 1-MC FILTER

A shielded, tuned LC filter designed to attenuate both higher and lower frequencies, while providing insertion gain at 1 megacycle.

Insertion Gain: When used with the TYPE 716-CS1 Capacitance Bridge and the TYPE 1212-A Unit Null Detector, the insertion gain at 1 Mc varies from 22 db to 32 db.
Second Harmonic Rejection: At least 39 db.
Maximum Input Voltage: 200 volts.
Terminals: TYPE 874 Connector at each end.



Dimensions: 2" diameter, 5" long. **Weight:** 9 ounces.

Type	Code Word	Price
1212-P2 One-Mc Filter.....	ANNUL	\$30.00

TYPE 1951-A, -E FILTERS



A tuned circuit designed for use at the input to a high-gain amplifier to prevent overload by spurious signal pickup. It is particularly useful for measurements on three-terminal circuits where both sides of the unknown are above ground.

Wound on a toroid and shielded with permalloy, this filter is highly astatic. A capacitive voltage divider across the input permits impedance matching for maximum sensitivity.

Frequency: TYPE 1951-A, 400 and 1000 cycles; TYPE 1951-E, 270 and 1000 cycles (intended for use with TYPE 1661-A Vacuum-Tube Bridge).

Second Harmonic Rejection: At least 30 db.
Insertion Gain: -15 db to +35 db depending on driving source resistance and frequency.

Accessories Supplied: One each TYPE 274-MB Double Plug, TYPE 274-NK Shielded Plug, TYPE 874-Q 6 Adaptor.

Dimensions: $3\frac{1}{8}$ x $3\frac{1}{4}$ x $4\frac{3}{8}$ inches, over-all.
Net Weight: $1\frac{3}{4}$ pounds.

Type	Code Word	Price
1951-A Filter.....	FIBRE	\$75.00
1951-E Filter.....	FURRY	80.00

TYPE DNT DETECTORS



USES: These assemblies are high-sensitivity, universal detectors for very high and ultra-high frequencies. The system is the recom-

mended null detector for the TYPE 1602-B U-H-F Admittance Meter, the TYPE 1601-A V-H-F Bridge, the TYPE 1607-A Transfer



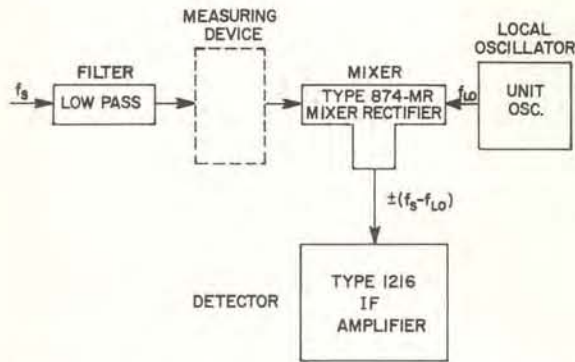

DESCRIPTION: Each assembly comprises one TYPE 874-MR Mixer Rectifier, one TYPE 1216-A Unit I-F Amplifier, one TYPE 874-G10 10-db Pad, one TYPE 874-EL 90° Ell, one Unit Oscillator and one filter depending on the frequency range desired (see price table.)

The incoming signal and the signal from the Unit Oscillator are heterodyned in the Mixer Rectifier to obtain a 30-Mc difference frequency. This beat frequency is amplified and indicated on the meter of the TYPE 1216-A Unit I-F Amplifier. The block diagram showing this method of detection is shown above. Higher frequency operation is obtainable by using oscillator harmonics, but sensitivity is decreased. Both the fundamental and harmonic ranges are shown in the curves below.

➤ When wide ranges of frequency are to be covered, however, it is recommended that one complete DNT Detector be purchased, plus the necessary oscillators and filters for the additional frequency ranges desired. For instance, to cover the range from 40 to 950 Mc, one would order a TYPE DNT-2 Detector, plus one TYPE 1209-B Oscillator and one TYPE 874-F1000 Filter.

FEATURES:

- Wide frequency ranges
- High sensitivity
- Linear response for gain-loss measurements
- AVC for null detector use
- Excellent shielding
- 80 db range

Function and Immittance Bridge, and the recommended standing-wave indicator for use with the TYPE 874-LBA Slotted Line and the TYPE 874-LM Dielectric Measuring Line.

The high sensitivity and wide frequency range of this detector make it useful as a general-purpose high-frequency receiver and voltmeter for laboratory use.

The wide bandwidth of the amplifier makes possible the detection of pulsed signals.

The built-in attenuator can be used for the accurate measurement of relative signal level, the insertion loss and attenuation of filters, attenuators and cables at high frequencies, and crosstalk in coaxial switches.

The heterodyne system of measuring high-frequency gain and attenuation, i.e., relative signal levels makes possible greater accuracy and wider ranges of measurement than does any other method.

Frequency range and sensitivity of TYPE DNT Detectors for both fundamental and harmonic operation.

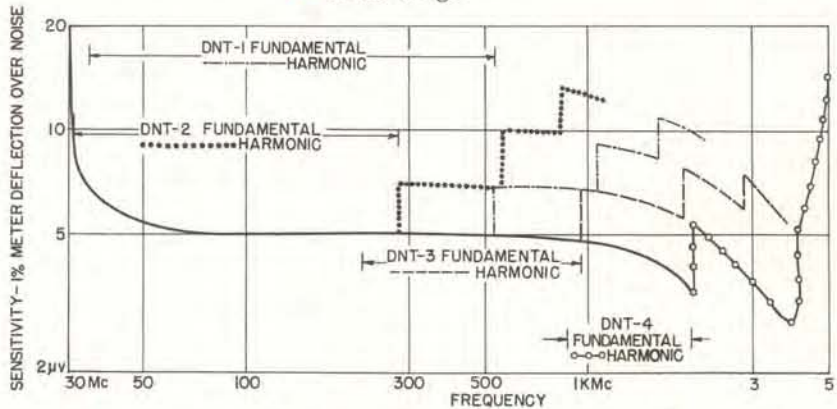

Type	Fundamental Frequency Range	Local Oscillator	Filter	Code Word	Price
DNT-1	40-530 Mc	1208-B	874-F500	NALTO	\$626.00
DNT-2	40-280 Mc	1215-B	874-F500	NERVO	606.00
DNT-3	220-950 Mc	1209-B	874-F1000	NULLO	659.00
DNT-4	870-2030	1218-A	874-F2000	NODDO	879.00

Mixer input terminal is TYPE 874 Coaxial Connector. For connections to other types, see TYPE 874-Q Adaptors

page 58. TYPE 874-R22 Patch Cord (page 56) is also a convenient accessory.



TYPE 1216-A UNIT I-F AMPLIFIER



USES: The Unit I-F Amplifier is the basic element in a general-purpose, high-frequency heterodyne detector. With the TYPE 874-MR Mixer Rectifier and a Unit Oscillator, it comprises a TYPE DNT Detector. Satisfactory operation can also be obtained with other mixers and oscillators.

DESCRIPTION: The TYPE 1216-A Unit I-F Amplifier consists of four tuned i-f amplifier stages, a detector, a video amplifier stage, an r-f attenuator, and two power supplies. It is designed to operate from a 400-ohm source impedance, which is the nominal output impedance of the TYPE 874-MR Mixer Rectifier.

Automatic volume control is provided for facilitating bridge balancing and other null-type measurements. The AVC can be switched out of circuit for voltage level measurements.

A built-in precision, film-type-resistor, step attenuator is included to make possible accurate measurements of relative signal levels as high as 70 db. The indicating meter is calibrated in db, as well as in linear units, for convenient interpolation between the 10-db attenuator steps.

The rectified crystal-mixer current produced by the oscillator signal in the TYPE 874-MR Mixer-Rectifier can be measured on the indicating meter. A knowledge of this current is important if attenuation measurements are to be made, since the oscillator voltage must be above a certain limit if the applied r-f signal is large. The current is also an indication that the oscillator is functioning.

One of the internal power supplies operates the amplifier circuits; the other supplies heater and plate power to the heterodyning Unit Oscillator.

FEATURES:

- Accurate attenuator.
- Large meter calibrated linearly and in db for interpolation between attenuator steps.
- High sensitivity with excellent shielding.
- Broad bandwidth with good selectivity.
- AVC provided for null detector use.
- Cathode follower amplifies modulation. Can be used with phones.
- Can check rectified local oscillator current.
- Provides power for external local oscillator.
- Small and compact assembly.
- Regulated screen voltage supply.

SPECIFICATIONS

Center Frequency: 30 Mc.
Bandwidth: Greater than 0.5 Mc at 3 db down; 9.5 Mc at 60 db down.
Sensitivity: From a 400-ohm source, 2μvolts input required for 1% meter deflection (above noise), 50 μvolts input for full-scale meter deflection. These are open-circuit source voltages.
Attenuator Range: 0-70 db in 10-db steps.
Attenuator Accuracy: ±(0.3 db +1%).
Output Circuit Bandwidth (modulation): 0.4 Mc.
Output Impedance: 600 ohms.
Maximum Output Voltage: 2 volts open circuit.
Terminals: Input, TYPE 874 Connector on 2-foot cable.
Output: 3/4-inch-spaced TYPE 938 Binding Posts.
Supplementary Power Supply Output: 300 volts dc at 30 ma;

6.3 volts ac at 1 a. With this power supply, full output will not be obtained from a Unit Oscillator, but output is ample for heterodyne use.
Power Supply: 105-125 or 210-250 volts, 50 to 60 cycles. Power input, 45 watts at full load. Can also be operated at 400 c where line voltage does not drop below 110 v.
Tube Complement: Two 6CB6; one each, 6AK5, 6AL5, 6U8, 0B2.
Accessories Supplied: Spare fuses; multipoint connector; power cord attached.
Mounting: Crackle finish aluminum panel and sides. Aluminum cover finished in clear lacquer.
Dimensions: Panel, 9 1/2 × 5 1/4 inches; depth behind panel, 5 1/8 inches.
Net Weight: 8 1/4 pounds.

Type		Code Word	Price
1216-A*	Unit I-F Amplifier.....	AMONG	\$335.00
480-P4U2	Relay-Rack Adaptor Panel	UNIPANBOLT	10.00

*PATENT NOTICE. See Note 4, page x.





TYPE 1233-A POWER AMPLIFIER

20 c to 20 kc

20 kc to 1.5 Mc

20 c to 3 Mc

USES: The wide frequency range and high power output of this amplifier make it adaptable to many uses in electronic and electro-acoustic laboratories. Typical uses are:

Driving acoustic generators.

Exciting antennas for radiation-pattern and impedance measurements.

Amplifying received signals for operating remote modulation and frequency monitors.

Amplifying weak signals for oscilloscope deflection.

DESCRIPTION: The excellent frequency response of this amplifier is obtained in three push-pull, broad-band circuits with series-peaked interstage couplings. The two power ranges use toroidal output transformers; the voltage-amplification range uses a series-peaked video-output network with gradual roll-off above 3 Mc. Ranges are selected by panel switch. Meter reads output volts and can be switched to read plate current of output tubes.

SPECIFICATIONS

Input Voltage: Less than 0.2 volt for full output.

Input Impedance: 100,000 ohms in parallel with 37 μf (grounded).

Power Supply: 105 to 125 (or 210 to 250) volts, 40 to 60 c; 120 watts at zero output; 140 watts maximum.

Instrument will operate with a maximum output of 10

watts on power-supply frequencies up to 400 cycles.

Power input receptacle will accept either 2-wire (TYPE CAP-35) or 3-wire (TYPE CAP-15) power cord. Two-wire cord is supplied. For 3-wire, see page 237.

Voltmeter: Full-wave-average type; 150, 50, and 15 watts f.s.; Accuracy $\pm 5\%$, compensated to 3 Mc.

Range Switch Position	Operating Freq. Range	OUTPUT		Optimum Load Impedance	Rise Time	Distortion at Rated Output	Noise Level
		Power*	Voltage				
20 c to 20 kc	20 c — 20 kc	8 watts	15 volts	600 or 150 Ω		3%	60 db below 15 watts, or equivalent to 200 μv input.
	50 c — 15 kc	15 watts					
20 kc to 1.5 Mc	20 kc — 1.5 Mc	8 watts	15 volts	50 Ω grounded		3%	70 db below 15 watts or equivalent to 63 μv input.
	20 kc — 0.5 Mc	15 watts					
20 c to 3 Mc	20 c — 3 Mc		150 volts, peak-to-peak, bal; 50 volts grounded	CRO deflection plates; 1 M Ω , 36" leads	0.1 $\mu\text{sec.}$	3%	0.6V, peak to peak, bal, or equivalent to 600 μv peak-to-peak input.
Disconnected	Any single frequency, 20 c to 5 Mc	15 watts, with external tuned output transformer					

* Rated output is obtainable at 105 volts line; output is greater for higher line voltages.



Output pulse waveforms 20c to 3 Mc range; input pulse rise time, 0.03 $\mu\text{sec.}$; three pulse lengths shown.

FREQUENCY MEASUREMENT



The determination of frequency directly in terms of time is a fundamental measurement, since frequency is the *time* rate of recurrence of a cyclical phenomenon.

Axiomatically, the basis of frequency measurement is time measurement, and, notwithstanding the discovery of atomic or molecular frequency standards, all frequency measurements are at present referred, directly or indirectly, to a standard time interval, determined by astronomical observations. There is more than one definition of time.¹ For frequency determinations and for standard-frequency radio transmissions, Universal Time is used, which is the same as Greenwich Mean Time and is based on the rate of rotation of the earth.

The astronomical observations are carried out by national observatories throughout the world. Their measurements are made available to users all over the world through radio time-signal transmissions, as well as by telegraph in their respective countries. In the United States, the U. S. Naval Observatory transmits high-precision time signals by radio through the facilities of the U. S. Naval Radio Service. Transmissions on a number of frequencies are available several times a day and can be received nearly all over the world. Standard time signals monitored by the Naval Observatory are also broadcast continuously by the standard-frequency transmitters of WWV, operated by the Bureau of Standards. A similar service is provided in Canada by the Dominion Observatory.

The user of a primary frequency standard can then conveniently determine the frequency of the standard in terms of the standard time interval sent to him by radio. In the General Radio equipment means are provided for quickly and easily making this comparison. For the most precise results, the errors of the transmitted time signal must be taken into account. Correction data may be obtained by applying to the Superintendent, U. S. Naval Observatory, Washington, D. C.

Since the astronomical clocks now used at the Naval Observatory are piezo-electric oscillators, similar to those used in accurate frequency standards, and since, through close cooperation of the U. S. Naval Observatory and the National Bureau of Standards, the piezo-electric oscillators of the latter's pri-

mary frequency standard are checked in the same way as the former's astronomical clocks, the comparison with time is, in effect, carried out by the observatory. The standard-frequency transmissions sent out by the Bureau of Standards consequently represent a primary standard of high precision available to all who can receive the transmissions. Where such transmissions can be received, it is generally more convenient and much quicker to make the comparison by frequency than by time. For information and schedules of transmission of standard frequencies, apply to the Radio Division, Bureau of Standards, Department of Commerce, Boulder, Colorado.

A calibration against transmitted radio frequencies yields a *pseudo-instantaneous* frequency value of the standard; while a calibration against transmitted time signals yields an *average* frequency value of the standard during the period between successive observations which, for precision, must be an interval of several hours.

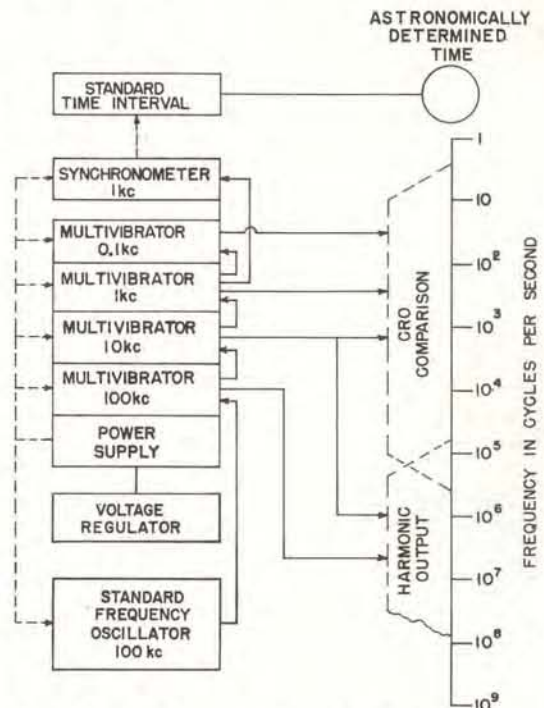

FIGURE 1. Block diagram showing the functional arrangement of the TYPE 1100-APV Primary Frequency Standard and the range of output frequencies available from it.

¹F. D. Lewis, "Frequency and Time Standards", *Proc. IRE*, September, 1955. (Reprint is available).





Because of the vagaries of high-frequency transmission, many users rely on checks against time as a reserve. They also use the primary standard as a high-precision clock for laboratory timing purposes.

As so far considered, the precision oscillator is a single-frequency device. For practical utility it is necessary to obtain from this single frequency many other frequencies, both above and below the standard frequency, for convenience in measurements. Since most of the precision oscillators operate in the region of 50 to 100 kc, it is necessary to divide the frequency to obtain a value such that a synchronous motor can be used to count the number of cycles executed by the precision oscillator in a standard interval of time. For measurements of high radio frequencies, it is necessary to multiply the standard frequency to obtain useful frequencies in the range of the frequency being measured. Both of these operations are readily performed by a controlled relaxation oscillator, known as a multi-vibrator.

**THE PRIMARY FREQUENCY STANDARD
TYPE 1100-APV**

The elements of a primary frequency standard, General Radio TYPE 1100-APV, are shown in Figure 1.

The frequency of the precision oscillator is 100 kc, which is divided successively by factors of 10 to obtain multivibrator fundamental frequencies of 10, 1, and 0.1 kc. A fourth multivibrator, operating at a fundamental frequency of 100 kc, provides a large number of harmonics at 100-kc intervals for use at high radio frequencies. Harmonics of the 10-kc multivibrator are similarly used. In the audio-frequency and low-frequency range (up to 100 or 200 kc) hundreds of known frequencies can be identified by the relation to the standard

FIGURE 2. View of the TYPE 1190 Quartz Bar used in TYPE 1100-A Frequency Standard, with cover removed, showing the spring suspension.

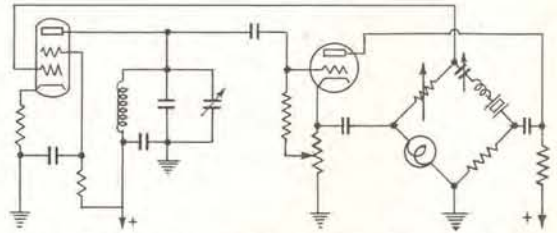
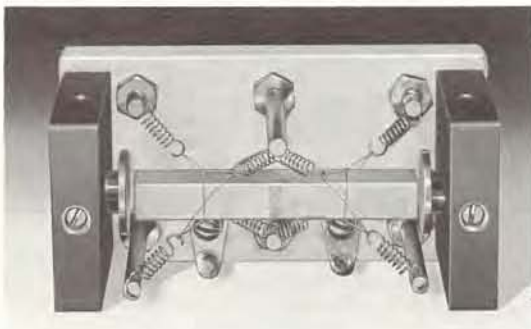

FIGURE 3. Elementary circuit of the bridge-type piezo-electric oscillator used in the TYPE 1100-A Frequency Standards.

10-kc frequency as indicated by stationary patterns on a cathode-ray oscilloscope.

The range of useful output frequencies obtainable from the General Radio Primary (or Secondary) Frequency Standard is indicated in Figure 1. Complete specifications are given on pages 74 to 76.

This frequency standard is the result of many years of continuous development in the General Radio laboratories. The quartz bar (and mounting), the oscillator circuit, and the temperature-control system used in the standard make possible a stability of a few parts in 10^8 over periods of several months, and a short-period stability of 0.5 part in 10^8 per day after one year's operation. The quartz bar and its mounting are shown in Figure 2. The bar vibrates in its second-harmonic extensional mode and is held at its two nodes in a spring suspension mounting in such a manner as to introduce a minimum of damping. Electrodes are formed directly on the surfaces of the quartz. The cross-sectional dimensions of the bar have been so chosen that the temperature coefficient of frequency is zero in the vicinity of the operating temperature of 60°C . The temperature-control system holds the temperature of the quartz bar constant to better than 0.01°C .

A bridge-type oscillator circuit is used, shown in schematic form in Figure 3. In this circuit, the crystal vibrates at its series-resonant frequency, and the amplitude of oscillation is constant.

**THE SECONDARY FREQUENCY STANDARD
TYPE 1100-AQV**

In the past there was a useful field for frequency standards of less than the best possible precision, such standards being checked frequently against standard frequency transmissions. These standards could be manufactured at a lower cost than the more precise standards and consequently were used in many applications where price was a governing consideration.



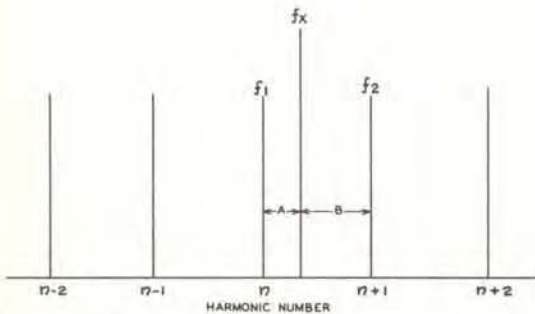

FIGURE 4. This diagram shows the relation between an unknown frequency and a standard harmonic series.

At present the demand for more accurate secondary standards, coupled with less expensive designs for primary standards, makes it undesirable to make two types of standard. Consequently, the same component units are offered for use as a secondary standard—the precision oscillator, and multivibrator and power supply unit, but without the Synchronometer unit. (This latter unit can be added later, if desired.)

THE UNIT TIME/FREQUENCY CALIBRATOR TYPE 1213-C

For applications such as receiver or oscillator testing and calibration, band-edge checking, frequency and time-marker generation, the TYPE 1213-C Unit Time/Frequency Calibrator has been developed. It provides standard-frequency harmonics at multiples of 10 Mc, 1 Mc, 100 kc, and 10 kc, which extend above 1000 Mc, 500 Mc, 250 Mc, and 25 Mc respectively. Calibration of time intervals on oscilloscopes is possible using the output pulses provided at intervals of 0.1 μ s, 1.0 μ s, 10 μ s, and 100 μ s. The small size, low cost, and good stability of the calibrator make it useful where the high stability and precision of the primary or secondary standard of frequency is not necessary, or where the installation of such relatively elaborate equipment is not feasible. In addition, the availability of time markers for oscilloscopic measurements and a self-contained beat detector for oscillator calibration enables this instrument to solve many laboratory measurement problems formerly requiring several different items of measuring equipment.

By means of simple, auxiliary oscillators and an oscilloscope, this calibrator, when standardized in terms of standard-frequency transmissions, can be used to measure frequencies up to 1000 megacycles per second with very good accuracy. It is particularly adapt-

able to the checking of the frequencies of radio and television transmitters and monitors. The method of measurement is discussed in a paper by Cady and Buuck², copies of which are available on request.

FREQUENCY MEASUREMENT

The ultimate precision in the measurement of an unknown frequency requires establishment of a series of standard frequencies embracing that portion of the frequency spectrum in which the measurement is to be made, followed by an evaluation of the unknown frequency with reference to one of the standard frequencies. Since any unknown frequency will lie between two of the standard frequency harmonics, as shown in Figure 4, the simplest process is to determine the difference in frequency between the unknown frequency and the nearest of the standard frequencies. This difference is added to the standard frequency if the unknown lies above the standard, or subtracted if the unknown lies below the standard frequency.

A convenient method of evaluating the frequency difference, A or B (Figure 4), consists of beating the standard and unknown frequencies in a detector and measuring the beat frequency by means of a frequency-measuring device covering the required interpolation range between the standard frequencies. Any one of a number of devices suitable for measuring the beat frequency may be used, including an accurately calibrated audio oscillator with a beat indicator, an electronic counter, or a direct-indicating frequency meter.

Perhaps the most reliable method of measuring this beat frequency is that making use of the calibrated audio oscillator, as shown in Figure 5. An advantage of this method is that a narrow-band receiver can be used when frequencies of remote transmitters must be measured in the presence of interference, noise, or

²C. A. Cady and W. P. Buuck, "Frequency Measurements in the Broadcast Field" (Paper delivered at Wescon, 1958).

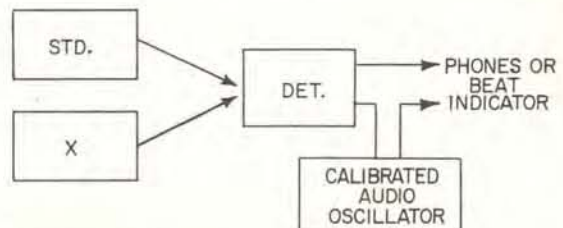

FIGURE 5. Functional diagram showing the operation of the direct-beating method of frequency measurement.



fading. In severe cases of noise, a heterodyne frequency meter can be matched to the desired frequency, and the measurement can be completed with the frequency meter as a substitute source, under conditions where no other method can be used. A further advantage of this method of operation is that the difference frequency is nearly always an audible tone, and the proper source for measurement can be identified by a listening test, as can all steps of the measurement. When depending upon counting or meter indications, the operator has no check on the presence or absence of interference or noise.

By use of the heterodyne frequency meter, any desired frequency can be set up and can be measured or monitored in terms of the standard. The equipment thus not only provides a means for *measuring* frequencies, but also provides for *generating* accurately known frequencies.

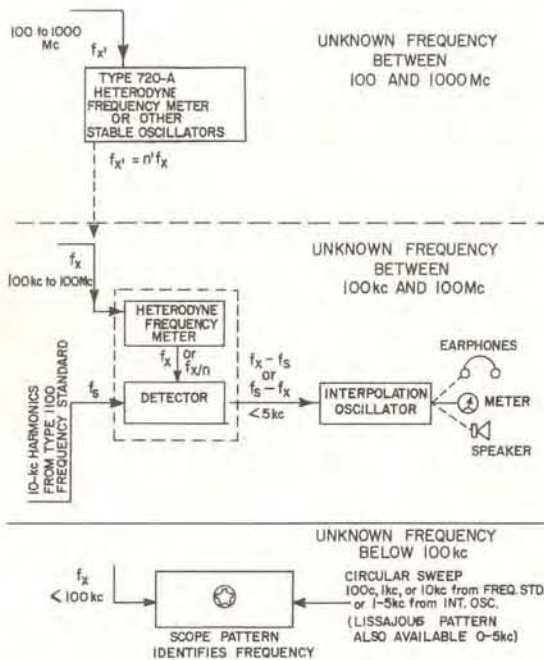

FIGURE 6. Functional diagram of the frequency-measuring system. The unknown frequency is normally applied to the detector section of the frequency transfer unit together with a series of standard harmonics. It can then be precisely determined through measurement of the difference between unknown and standard in terms of the interpolation oscillator. For high frequencies the harmonic of an auxiliary oscillator can be matched to the unknown, while the oscillator fundamental is measured.

The TYPE 1105-A Frequency Measuring Equipment is an assembly of the necessary instruments for measuring unknown frequencies in terms of standard-frequency harmonics obtained from the TYPE 1100 Frequency Standard. This assembly includes an interpolation oscillator and comparison oscilloscope for the measurement of audio and beat frequencies, as well as the necessary radio-frequency detectors and calibrated oscillators used in the measurement of the higher frequencies. For a complete description, see pages 76 to 78.

HETERODYNE FREQUENCY METERS

In addition to the heterodyne-frequency-meter oscillators included in the TYPE 1105-A Frequency Measuring Equipment, specialized types of heterodyne-frequency-meter oscillators have been developed to cover higher frequency ranges.

The TYPE 720-A Heterodyne Frequency Meter, described on page 87, contains a calibrated oscillator, using the General-Radio-developed butterfly circuit, covering the fundamental frequency range of 100 to 200 Mc, together with a suitable detector circuit and audio amplifier for detecting beat notes. The stability of this oscillator is sufficient to provide measurements to an accuracy of 0.1%. Harmonics of the oscillator enable frequency measurements up to 3000 megacycles to be made. This one instrument, being battery operated, directly calibrated, and completely portable, is the basic vhf-uhf frequency-measuring device for many laboratory or field applications.

If the fundamental of the heterodyne frequency meter is checked against the TYPE 1100 Frequency Standard, the accuracy of measurement at the harmonics can be improved to approximately 0.01%.

For frequency measurements up to about 30 Mc, a simplified frequency-measuring set-up can be used, in conjunction with the TYPE 1100 Frequency Standard and a sensitive high-quality receiver. This assembly omits the heterodyne frequency meters and consists of the interpolation oscillator, comparison oscilloscope and coupling panel.

AUDIO FREQUENCIES

For the measurement of audio frequencies the TYPE 1107-A Interpolation Oscillator offers the convenience of a linear scale.





TYPE 1100-A FREQUENCY STANDARDS

The TYPE 1100-A Frequency Standards are highly precise standards of frequency, operating on the principles outlined on pages 69 and 70. Two models are available, the TYPE 1100-APV Primary Standard and the TYPE 1100-AQV Secondary Standard. The same basic elements are used in each, and there is no difference in accuracy and stability between the two assemblies.

The primary standard is provided with a Synchronometer (synchronous motor clock) for evaluating its frequency directly in terms of standard time. The secondary standard has no Synchronometer. All other specifications are identical with those for the primary standard.

Harmonic series based on fundamentals of 0.1, 1, 10 and 100 kilocycles are available at its output terminals to furnish usable standard frequencies over a wide range. The stability of all output frequencies is the same and is better than one part in ten million over periods of several weeks.

Each assembly is supplied in a floor-type relay rack.

A functional layout of the standard is shown on page 69. Brief descriptions of the individual units are given on the following page, and complete specifications on page 75.

A specially designed assembly of frequency measuring equipment for use with these standards is described on pages 76 to 78.

General Radio Frequency Standards are known the world over for reliability and accuracy. They are used by governmental agencies, industrial plants, military services, and research laboratories. Current models have all the features of earlier ones, plus many additional advantages in convenience, size, weight, performance and appearance, that result from General Radio's continuous program of research and development in the field of frequency standardization and measurement.

The primary standard is an excellent national standard of frequency for communications ministries, and with the TYPE 1105-A Frequency Measuring Equipment, can be used to monitor or to measure the frequencies of radio stations. It is also suitable for use as a standard clock by observatories. Research laboratories and radio manufacturing plants should use the primary standard whenever the requirements make it advisable to have an independent check against time.



Close-up view of the TYPE 1100-APV Primary Frequency Standard. Lower part of the floor-type relay rack is not shown. The complete rack is similar to that shown in the photograph on page 76. The voltage regulator is not shown in either view.

For many uses the timing feature of the primary standard is not needed, and the secondary standard, which offers the same stability at a lower price, can be used. With the secondary standard, an accurate check upon its frequency can be made by a comparison with standard-frequency radio transmissions such as those of the National Bureau of Standards at Washington. This comparison is adequate to evaluate the frequency of the standard to a few parts in 10^8 .





Shown below are the individual panels that make up the standard, with brief descriptions of their characteristics. Additional details of

circuit and construction will gladly be supplied upon request. Specifications and prices are listed on page 75.

TYPE 1103-A SYNCHRONOMETER

This panel includes a 1000-cycle synchronous motor for effectively counting the number of cycles executed by the standard piezo-electric oscillator in a standard time interval. A large, illuminated, 24-hour dial with a long sweep hand makes for easy visibility. A microdial contactor, operating once each second, and calibrated in hundredths of a second, is provided for comparison with time signals. The microdial mechanism can be phased by means of a panel control. Comparison of the synchronometer reading with standard time can be made on the microdial scale to one part in ten million over a 24-hour interval. When the microdial is used in conjunction with the TYPE 1109-A Comparison Oscilloscope, time comparisons can be made to one millisecond or one part in 10^8 for 24 hours.



TYPE 1102-A MULTIVIBRATOR AND POWER SUPPLY UNIT

This unit contains four multivibrators of 100, 10, 1, and 0.1 kc frequencies, the power supply for the entire standard, and the control circuits of the temperature-control system of the TYPE 1101-A Piezo-Electric Oscillator. Concentric shielded connectors are provided for 100-kc and 10-kc harmonic outputs for radio-frequency measurements, and 10 kc, 1 kc and 0.1 kc for audio-frequency measurements. These connections are all mounted on the rear of the assembly. All tubes are accessible from the rear, without removal of any dust covers. The four multivibrators are mounted on the rear panel, which is removable without disconnecting any wiring. Mounting spacers and servicing cable are supplied to operate the multivibrators when the panel is reversed, giving access to all components of the multivibrator assembly.



TYPE 1101-A PIEZO-ELECTRIC OSCILLATOR

This oscillator operates with a TYPE 1190 Quartz Bar, which is mounted in the temperature-control unit, located at the left behind the panel. The temperature is controlled by a compensated-thermostat circuit and is held within $\frac{1}{250}$ of the variation in ambient temperature. The oscillator circuit assembly is mounted at the right behind the panel. All tubes are accessible from the rear without removing any dust covers.

A view of the TYPE 1190 Quartz Bar is shown on page 70.



TYPE 1570-ALR (or -AHR) AUTOMATIC VOLTAGE REGULATOR

This latest addition to the frequency standard holds

TYPE 480-PA CABINET RACK

(not shown above, see page 76 for photo)

A floor-type cabinet rack is supplied to house the complete frequency standard. When the TYPE 1105-A

supply voltage constant to 0.25% with resultant increase in frequency stability of the crystal oscillator. Description and photo on page 216. The standard can also be supplied without voltage regulator.

Frequency Measuring Equipment is ordered with the standard, the complete assembly is mounted as shown on page 76. Openings, with removable finished covers, are provided for connections between the standard and the TYPE 1105-A Frequency Measuring Equipment.

SPECIFICATIONS

Frequency Range: Standard frequencies ranging from one pulse per second to frequencies of several megacycles can be obtained from this equipment.

The output frequencies are as follows: The upper frequency limit depends upon the method used to detect and utilize the harmonics. The values here quoted are





easily reached when using the TYPE 1106 Frequency Transfer Units.

From 100-kc multivibrator, 100 kc and its harmonics up to 50 megacycles.

From 10-kc multivibrator, 10 kc and its harmonics up to 10 megacycles.

From 1-kc multivibrator, 1 kc and its harmonics in the audio-frequency range.

From 100-cycle multivibrator, 100 cycles and its harmonics in the lower audio range.

From the synchronometer unit, one-second contactor. The time of occurrence of the contact may be phased to occur at any instant over a range of one second.

This contact is open for about 50 and closed for 950 milliseconds.

If a suitable high-frequency receiver is used to detect them, 100-kc harmonics up to 75 or more megacycles can be utilized directly. For work at higher frequencies, harmonics of an auxiliary oscillator whose fundamental is monitored against the standard at a lower frequency can be used.

Output Voltage: The harmonic outputs of the 100 and 10 kc are at low impedance (65 ohms). The r-m-s voltages, measured at the terminals of the frequency standard, across a 65-ohm load, are: at 100 kc, 0.2 volt; and 10 kc, 1.2 volts. The audio-frequency outputs are at low impedance (600 ohms). The r-m-s voltages measured at the terminal strip of the standard, across a 10,000-ohm load, are: 10 kc, 20 volts; 1 kc, 25 volts; 100 cycles, 20 volts. These voltages are representative only; they are not guaranteed values.

Frequency Adjustment: The frequency of the quartz bar in its oscillator circuit is adjusted to within 1 part in ten million of its specified frequency in terms of standard time. Slight changes in frequency may occur during shipment, but a control is provided for adjusting the frequency after installation.

Long-Term Stability: When the assembly is operated in accordance with instructions, and after an aging period of a month, the rate of drift of the frequency will remain below 5 parts in 10⁸ per day averaged over 10 days and this will decrease with time to about 0.5 part in 10⁸ per day at the end of one year's operation.

Short-Term Stability: The standard is designed so that ordinary changes in air pressure, ambient temperature, and line voltage have practically no effect on the frequency. The temperature coefficient of frequency of

the quartz bar is less than 1 part in 10⁷ per degree C. The temperature variation of the oven is less than 1/250 of the ambient temperature variation. The voltage coefficient of frequency of the crystal-controlled oscillator is less than 2 parts in 10⁸ for line voltage changes of 10%. The voltage regulator eliminates fluctuations from this source.

The fluctuations of frequency of the standard over short periods, such as those required in making frequency measurements, are less than 1 part in 10⁹.

Output Terminals: The various output frequencies are made available at TYPE 874 Coaxial Connectors at the rear of the assembly. Since all necessary wiring, for all interconnections between units of the assembly, is provided in the form of cables, no connections need be made by the user other than power-supply connections, and a connection to the point where the standard frequencies are to be used.

Tube Complement:

1—6AC7 1—5R4-GY 1—6K6-GT/G
10—6SN7-GT 1—1N34A 1—2LAP-430

Power Supply: 105 to 125 (or 210 to 250) volts, 60 cycles. Specify voltage when ordering. For 50-cycle models, see price table below.

Power input receptacle will accept either 2-wire (TYPE CAP-35) or 3-wire (TYPE CAP-15) power cord. Two-wire cord is supplied. For 3-wire, see page 237.

Power Input: For the TYPE 1100-AQV Secondary Standard, the power demand from the supply line is approximately 190 watts; with heaters off, the power required is approximately 160 watts. For the TYPE 1100-APV Primary Standard, the corresponding figures are 210 and 180 watts, respectively.

Accessories Supplied: Complete set of tubes, spare sets of fuses, fusible links, pilot lights. All connecting cables, including power-supply leads, servicing cable, and complete operating instructions.

Mounting: All units are mounted on standard 19-inch relay-rack panels finished in crackle lacquer, dress panel construction. A floor-type cabinet rack, wrinkle finish, is supplied for mounting the units of the assembly. Blank panels are supplied to fill unused portion of rack.

Dimensions: The over-all dimensions of the assembly in floor-type cabinet rack are (height) 76 1/8 x (width) 22 x (depth) 20 1/2 inches, over-all. The available panel space is 40 rack units or 70 inches.

Net Weight: In floor-type racks, TYPE 1100-APV, 392 pounds, TYPE 1100-AQV, 357 pounds.

Type		Code Word	Price
1100-APV	Primary Frequency Standard (for 60-cycle service) ...	EXCEL	\$2930.00
1100-AQV	Secondary Frequency Standard (for 60-cycle service)	EXACT	2180.00
1100-APVQ6	Primary Frequency Standard (115 volts, 50 cycles) ...	EXCELPASHA	2955.00
1100-AQVQ6	Secondary Frequency Standard (115 volts, 50 cycles)	EXACTPASHA	2205.00
1100-APVQ11	Primary Frequency Standard (230 volts, 50 cycles) ...	EXCELREGAL	2955.00
1100-AQVQ11	Secondary Frequency Standard (230 volts, 50 cycles)	EXACTREGAL	2205.00

PATENT NOTICE. See Notes 1, 2, 4, page x.

The TYPE 1116-A Emergency Power Supply, a vibrator-type instrument operating from storage batteries is available on special order. When the ac line fails, this power supply is switched into service automatically, without interruption of the timing sequence.

The TYPE 1100-APV Primary Frequency Standard consists of:

- 1 TYPE 1103-A Synchronometer
- 1 TYPE 1102-A Multivibrator and Power Supply Unit
- 1 TYPE 1190-A Quartz Bar Mounted in Oscillator
- 1 TYPE 1101-A Piezo-Electric Oscillator
- 1 TYPE 1570-A Automatic Voltage Regulator
- Relay Rack, Blank Panels, Connecting Cables

The TYPE 1100-AQV Secondary Frequency Standard consists of:

- 1 TYPE 1102-A Multivibrator and Power Supply Unit
- 1 TYPE 1190-A Quartz Bar Mounted in Oscillator
- 1 TYPE 1101-A Piezo Electric Oscillator
- 1 TYPE 1570-A Automatic Voltage Regulator
- Relay Rack, Blank Panels, Connecting Cables



TYPE 1105-A FREQUENCY MEASURING EQUIPMENT



View of TYPE 1105-A Frequency Measuring Equipment with TYPE 1100-APV Primary Frequency Standard. The measuring equipment assembly is supplied with one floor-type relay rack, and the TYPE 1107-A Interpolation Oscillator mounts in the frequency standard rack, below the standard.

The TYPE 1105-A Frequency Measuring Equipment is the result of a quarter century of continuous development, and simplicity of operation has, next to accuracy, been the guiding principle in its design.

It includes all the auxiliary equipment necessary for the accurate measurement of unknown frequencies in terms of the TYPE 1100-A Frequency Standards.

When this assembly is used with any model

of the TYPE 1100-A Frequency Standard, measurements can be made directly at frequencies up to 25 Mc. Measurements at higher frequencies can be made by using the transfer-oscillator method to transfer the unknown frequency in known harmonic steps to a frequency in the direct-measurement range.

The individual instruments comprising the TYPE 1105-A Frequency Measuring Assembly are available separately, and all are described in detail in the following pages. Where the frequency range to be used is smaller or the type of measurement to be made is specialized, simpler assemblies can be furnished, and quotations will be made upon request.

METHOD OF MEASUREMENT

The general method of measurement is outlined in the diagram on page 72. At radio frequencies between about 100 kc and 100 Mc, the unknown frequency is brought into the measuring system through the detector section of a frequency transfer unit or through an external radio receiver. The direct-reading scale of the frequency transfer unit gives the approximate value of the unknown frequency. For a precise determination, the beat frequency between the unknown and a standard-frequency harmonic is measured by comparison with the interpolation oscillator, the comparison being made on the oscilloscope.

Above 100 Mc an external frequency meter such as the TYPE 720-A can be used to establish a harmonic relation between the unknown and the standard frequency. Other types of stable oscillators can also be used for this purpose.

At audio frequencies, the interpolation oscillator is matched directly to the unknown frequency. A harmonic of the unknown can be measured at low audio and sub-audible frequencies.

Between about 5 kc and 100 kc, the interpolation oscillator is used to produce a variable-frequency circular sweep on the oscilloscope. The unknown frequency can then be determined from the oscilloscope pattern.

By reversal of the procedure of measurement, a precisely known frequency of any value between 100 kc and 100 Mc can be generated. The desired frequency is available at the output terminals of a frequency transfer unit. From the interpolation oscillator, audio frequencies between 0 and 5000 cycles are available.



TYPE 1109-A COMPARISON OSCILLOSCOPE

This unit contains a cathode ray oscilloscope, with its power supply; selecting, smoothing, and phase-shifting networks for circular sweeps at line frequency, 0.1, 1, and 10 kc standard frequencies, and at a variable frequency obtained from the interpolation oscillator; and a selector providing for all necessary and convenient comparisons required in making frequency measurements. Most patterns are presented on a circular sweep by radial deflection.

For complete description, see page 83.

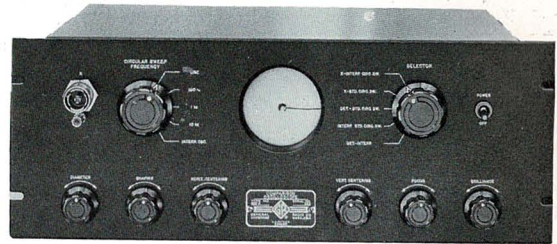

TYPE 1106-A, -B, -C FREQUENCY TRANSFER UNITS

(3 Panels)

Each of these units contains a heterodyne frequency meter and heterodyne detector, with direct-reading scales. Ranges are as follows:

- TYPE 1106-A 100 kc to 2000 kc
- TYPE 1106-B 1 Mc to 10 Mc
- TYPE 1106-C 10 Mc to 100 Mc

The harmonic output of the frequency meter can be used at frequencies higher than those covered by the dial ranges, as explained in the operating instructions. The output of the frequency meter is adjustable by a panel control, as is the regeneration of the heterodyne detector.

For complete description, see page 79.



TYPE 1108-A COUPLING PANEL

This unit is the centralized control point at which all switching and level adjustments necessary for using the various combinations of measuring equipment can be easily and quickly carried out.

For complete description, see page 82.



TYPE 1107-A INTERPOLATION OSCILLATOR

This unit is a direct-reading audio-frequency oscillator covering frequencies from 0 to 5000 cycles. It is used to measure the audio-frequency difference between the unknown frequency and a standard 10-kc harmonic. Provision is made, on two scales, so that results can be obtained by addition only, avoiding subtraction. A mixer circuit is provided with controls for output of the interpolator and for the unknown frequency, so that a maximum beat amplitude can be obtained. A meter indicates output voltage and can be used as a beat indicator for matching the interpolator and unknown frequencies.

For complete description, see page 81.



TYPE 480-MA RELAY RACK

The individual units, with the exception of the TYPE 1107-A Interpolation Oscillator, are mounted in the TYPE 480-MA Relay Rack. At the base of the rack is

Each of the instruments comprising the TYPE 1105-A Frequency Measuring Equipment is available separately. All are completely described in the following pages, and those descriptions should be consulted for further details of design and construction, net weight, dimensions, etc.

mounted a TYPE 1105-P1 Speaker for audible monitoring of beat tones.

All connections between standard and measuring assembly are made by means of patch cords, which are supplied.





TYPE 1105-A FREQUENCY MEASURING EQUIPMENT

SPECIFICATIONS

Accuracy of Measurement: The accuracy of measurement that can be realized is ± 0.1 cycle in determining the difference between unknown and standard frequencies. The resolution varies with the frequency being measured, ranging from 2 in 10^5 at low frequencies to 1 in 10^8 at high frequencies.

Terminals and Connections: All instruments are equipped with TYPE 874 Coaxial Connectors on the rear of each unit. Suitable connecting cords are supplied.

Power Supply: 105 to 125 (or 210 to 250) volts, 50-60 cycles. Power input receptacle will accept either 2-wire (TYPE CAP-35) or 3-wire (TYPE CAP-15) power cord. Two-wire cord is supplied. For 3-wire, see page 237.

Power Input: 200 watts.

Accessories Supplied: Spare sets of fuses; blank panels; connecting cables, including power supply cords.

Mounting: The complete assembly, with the exception of TYPE 1107-A Interpolation Oscillator, mounts in a standard 19-inch TYPE 480-MA Cabinet Rack. This rack includes service outlets for each instrument. The interpolation oscillator mounts in the frequency standard rack, as shown in the photograph on page 76.

Dimensions: (Height) $76\frac{1}{8}$ × (width) 22 × (depth) $20\frac{1}{2}$ inches, over-all. Total rack space is 40 rack units, or 70 inches.

Net Weight: 370 pounds, including rack.

Type	Code Word	Price
1105-A Frequency-Measuring Equipment	MITER	\$5595.00

PATENT NOTICE. See Note 4, page x.

The TYPE 1105-A Frequency Measuring Equipment consists of:

- 1 TYPE 1109-A Comparison Oscilloscope.
- 1 TYPE 1106-A Frequency Transfer Unit.
- 1 TYPE 1106-B Frequency Transfer Unit.
- 1 TYPE 1106-C Frequency Transfer Unit.

- 1 TYPE 1106-C Frequency Transfer Unit.
- 1 TYPE 1108-A Coupling Panel.
- 1 TYPE 1105-P1 Speaker Mounted on Relay Rack.
- 1 TYPE 1107-A Interpolation Oscillator.
- Relay Rack, Blank Panels, and Connecting Cables.

This diagram shows in functional form the operation of the TYPE 1105 Frequency Measuring Assembly. The TYPE 1108 Coupling Panel is the central unit from which all operations are controlled.

The unknown frequency f_x and a series of standard frequency harmonics are applied through atten-

uators to the detector in the frequency transfer unit. The unknown frequency can then (1) be estimated quickly from the calibration of the detector, (2) be determined more accurately by use of the heterodyne frequency meter, or (3) be measured precisely by use of the interpolation oscillator.

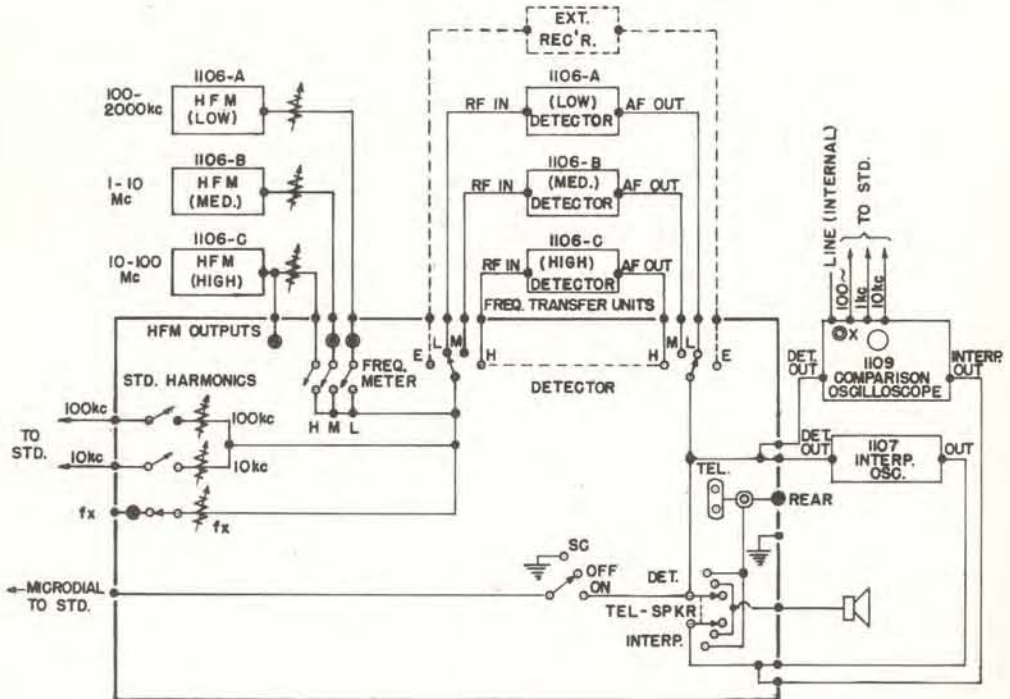



TYPE 1106 FREQUENCY TRANSFER UNITS

USES: The TYPE 1106 Frequency Transfer Units are utilized in transferring an unknown frequency for measurement against a frequency standard, or for transferring a frequency of known value (determined against the standard) to an output circuit. The direct-reading frequency calibrations will give the approximate value of an unknown frequency or the approximate value of a desired frequency in the output circuit.

When used with a frequency standard, these units provide means for rapidly identifying the harmonics of the standard; for accurately matching the heterodyne frequency meter to the unknown frequency; for use as a substitute source in measuring frequencies under conditions of noise, fading, or of intermittent operation of the transmitter; and for obtaining any desired frequency accurately known in terms of the standard.

The Frequency Transfer Units can also be used as general-purpose calibrated frequency meters and detectors.

DESCRIPTION: The TYPES 1106-A, 1106-B and 1106-C Frequency Transfer Units are identical except for their frequency ranges which are:

TYPE 1106-A	100 kc to 2000 kc
TYPE 1106-B	1 Mc to 10 Mc
TYPE 1106-C	10 Mc to 100 Mc

Each consists of a heterodyne frequency meter (with harmonic-generating circuits and output control) and a heterodyne detector

(with audio-frequency amplifier and regeneration control).

The heterodyne-frequency-meter oscillator circuit is a highly stable oscillator having a frequency range of 2 to 1 in two (1106-A) or three steps (1106-B, -C). A direct-reading frequency scale is provided for the fundamental and selected harmonic ranges, covering 10 to 1 in frequency (20 to 1 on 1106-A). The harmonic output can be used at frequencies higher than those covered on the dial ranges; for example, using the fundamental frequency scales and reading ten times the scale value gives the coverage of the tenth harmonic. An auxiliary fine-tuning control is provided for easily setting zero beat.

The heterodyne detector has range-switching and direct-reading frequency scales covering the rated range of the unit. The detector can be operated either in the non-oscillating or oscillating condition by use of the regeneration control. When oscillating, it is especially useful in obtaining an exact zero beat setting between the frequency meter and a signal frequency, by the three-oscillator method, the detector serving as the third oscillator. When not oscillating, it produces the beat between the standard harmonic and the unknown frequency. An audio-frequency amplifier with an output impedance of approximately 600 ohms is provided.

On both the heterodyne frequency meter and detector direct-reading frequency scales,



nearly 360-degree rotation of the drum dials is used. Both are approximately straight-line-frequency in calibration. Operation of the range selectors automatically sets the pointers so that the possibility of error in reading is greatly reduced.

FEATURES:

- Dials are direct reading in frequency.

- Range dials are illuminated and are mounted behind a panel window.
- Range switching for both frequency meter and detector.
- The heterodyne frequency meter is designed for a high degree of frequency stability, and drift is negligible for the specified conditions of use.

SPECIFICATIONS

Frequency Range:

TYPE 1106-A	100 kc to 2000 kc (9 ranges)
TYPE 1106-B	1 Mc to 10 Mc (10 ranges)
TYPE 1106-C	10 Mc to 100 Mc (10 ranges)

The heterodyne frequency meters all have 2:1 fundamental ranges, with calibrated direct-reading harmonic scales. The heterodyne detectors all have fundamental ranges covering the specified band.

Calibration: The heterodyne frequency meter dials are calibrated as follows:

TYPE 1106-A HFM	1 kc intervals	100-280 kc
	2 kc intervals	280-560 kc
	5 kc intervals	560-1000 kc
TYPE 1106-B HFM	10 kc intervals	1000-2000 kc
	5 kc intervals	1.0-2.0 Mc
	10 kc intervals	2.0-4.0 Mc
TYPE 1106-C HFM	20 kc intervals	4.0-5.0 Mc
	10 kc intervals	5.0-10.0 Mc
	20 kc intervals	10.0-20.0 Mc
	100 kc intervals	20.0-40.0 Mc
	200 kc intervals	40.0-50.0 Mc
	100 kc intervals	50.0-100.0 Mc

The heterodyne detector dials are calibrated with somewhat greater frequency intervals, but the intervals permit reasonable estimation of frequency.

Accuracy: The accuracy of the heterodyne frequency meter calibration permits positive identification of harmonics when used with a frequency standard. Used individually, the calibration can be relied upon to ±0.1 per cent.

Frequency Stability: The circuits of the oscillators used for the heterodyne frequency meters are designed for high stability against changes in supply voltage or changes in tube capacitances. The heterodyne detector stability is not as good but is sufficiently high so that no difficulty is encountered from variations in making frequency measurements.

Input and Output Circuits: The harmonic output of the heterodyne frequency meters is available at shielded

coaxial connectors for use with 50-65 ohm concentric cable. Harmonics of the fundamental frequency to at least the 10th are usable. The radio-frequency input and the audio-frequency output connections of the heterodyne detector are shielded coaxial connectors. The input circuit is suitable for use with 50-65 ohms cable; the output impedance is approximately 600 ohms.

Power Supply: 105 to 125 (or 210 to 250) volts, 50-60 cycles.

Power input receptacle will accept either 2-wire (TYPE CAP-35) or 3-wire (TYPE CAP-15) power cord. Two-wire cord is supplied, unless instrument is ordered as part of TYPE 1105-A assembly. For 3-wire, see page 237.

Power Input: 40 watts.

Tube Complement:

TYPE 1106-A, -B	TYPE 1106-C
3-6SJ7	1-6SJ7
1-6J5GT	1-6J5GT
1-6SN7GT	1-6SN7GT
1-1N51 (G.E. Co.)	1-6X4
1-6X4	1-6AK5
1-0D3	1-0D3
	2-9002

Accessories Supplied: Spare fuses; CAP-35 line connector cord; three TYPE 874-C62 Cable Connectors (if instrument is not ordered as part of TYPE 1105-A assembly).

Controls: Power ON-OFF switch; heterodyne frequency meter PLATE supply switch; heterodyne frequency meter and heterodyne detector RANGE (coil selector) switches; frequency controls; heterodyne frequency meter OUTPUT control; heterodyne detector REGENERATION control.

Mounting: Standard 19-inch relay-rack mounting; dress-panel construction; crackle lacquer finish.

Dimensions: Panel (length) 19 × (height) 10½ inches; behind panel, (depth) 12¾ inches.

Net Weight: 47¾ pounds.

Type		Code Word	Price
1106-A	Frequency Transfer Unit 100-2000 kc.....	ABOUT	\$1050.00
1106-B	Frequency Transfer Unit 1-10 Mc.....	ACTOR	1050.00
1106-C	Frequency Transfer Unit 10-100 Mc.....	ADEPT	1050.00

PATENT NOTICE. See Note 4, page x.

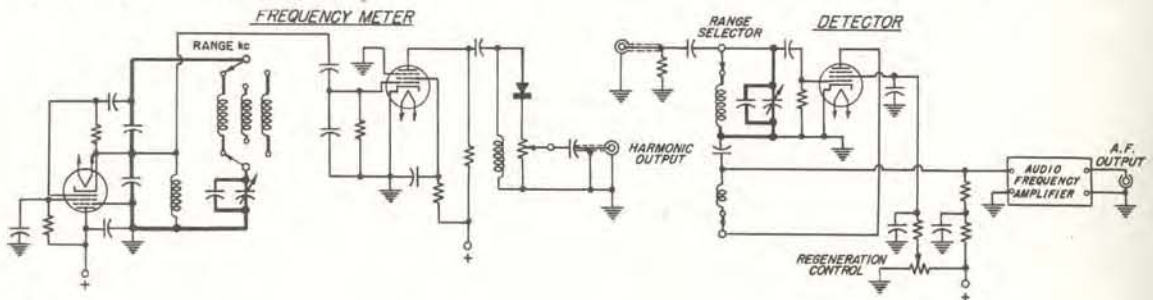



TYPE 1107-A INTERPOLATION OSCILLATOR

USES: The principal use of the TYPE 1107-A Interpolation Oscillator is, in connection with a frequency standard, to measure the difference between the unknown frequency and a known standard harmonic. The direct-reading linear scales of 0 to 5000, and 5000 to 10,000 cycles make possible the rapid evaluation of the frequency difference, by *addition* only, with high accuracy. While the dials are marked as described, the actual frequency range is 0-5000 cycles.

The linear scale of this oscillator also makes it useful for other types of work where accurate frequency increments are desired.

DESCRIPTION: The oscillator is of the beat-frequency type, with the radio-frequency oscillators operating in the region of 45-50 kc. The circuits are designed for exceptional stability of frequency against supply-voltage changes, tube-capacitance changes and tube replacements. A tube plate-supply regulator is then employed as a further safeguard.

The variable-frequency-oscillator frequency is controlled by a precision variable air capacitor, the fixed oscillator frequency by a fixed air capacitor. The inductors of both oscillator circuits are wound on ceramic forms and are shielded, effectively eliminating unwanted coupling and reducing the effects of changes in ambient temperature.

An output voltmeter is provided, which can

also be used as a beat indicator for matching the oscillator output frequency to an unknown audio frequency. Individual controls are provided for the oscillator output and unknown-frequency voltages in order to secure the maximum beat amplitude at any level. The oscillator output voltage is practically constant over the whole range of frequency.

FEATURES:

- The fixed oscillator is provided with a switch that permits changing its frequency by exactly 5000 cycles. The corresponding frequency scale reads 5000-10,000 cycles. For the measurement of a frequency lying below the standard frequency, the beat frequency need not be subtracted from the standard frequency to obtain the unknown frequency. Instead, the 5000-10,000 cycle scale is used and the reading is added to the frequency of the next lower standard-frequency harmonic.

- An indicator light operated by the switch indicates the proper scale to be read.

- Stability of output frequency, and linear, easily read scales are features of great convenience in use.

- For the measurement of very small frequency increments, two direct-reading incremental frequency dials (one for the 0-5000 scale and one for the 5000-10,000 cycle scale) are provided.



SPECIFICATIONS

Actual Frequency Range: 0-5000 cycles per second.
Dial Calibrations: DIRECT: 0-5000 cycles, with the oscillator frequency increasing from 0 to 5000 divisions on the scale. REVERSE: 5000-10,000 cycles with the oscillator frequency decreasing from 5000 cycles to zero while scale reading goes from 5000-10,000 divisions. Δf REVERSE and Δf DIRECT: ± 10 cycles.

Accuracy: The instrument is aligned to agree with the linear direct-reading scales to within ± 2 cycles.

The variable capacitor is provided with a precision worm drive so that precise frequency settings can be made. Small residual errors are easily and quickly removed in the region of any frequency in the range by fine adjustment of the zero with reference to a frequency standard having a 1-kc or 0.1-kc output, or both. For evaluating very small frequency differences, independent, direct-reading frequency-increment dials are provided.

Output: Adjustable up to 15 volts. The output-circuit impedance is approximately 600 ohms.

Mixer Circuit: A mixer circuit, with volume control, is provided for injecting a frequency to be measured into the amplifier circuit. Beats may be observed on the out-

put meter, or by means of head telephones or speaker.
Power Supply: 105 to 125 (or 210 to 250) volts, 50-60 cycles.

Power input receptacle will accept either 2-wire (TYPE CAP-35) or 3-wire (TYPE CAP-15) power cord. Two-wire cord is supplied, unless instrument is ordered as a part of TYPE 1105-A assembly.

Power Input: 50 watts, approximately.

Meters: Output voltmeter; used also as a beat indicator.

Terminals: Terminals, both on panel and at rear, are provided for both mixer input and oscillator output. Panel terminals are universal for two-pin or coaxial connectors. Rear terminals are for coaxial connectors.

Tube Complement:

- 2-6AC7
- 1-0D3
- 2-6SN7GT
- 3-6J5GT
- 1-6X5GT

Accessories Supplied: Spare fuses; TYPE CAP-35 Power Cord; four TYPE 874-C62 Cable Connectors (if instrument is not a part of TYPE 1105-A assembly).

Mounting: Standard 19-inch relay-rack; dress panel construction; crackle finish.

Dimensions: Panel (length) 19 × (height) 12¼ inches; behind panel, depth 1½ inches. **Net Weight:** 41½ pounds.

Type		Code Word	Price
1107-A	Interpolation Oscillator.....	BARON	\$1025.00

PATENT NOTICE. See Note 4, page x.

TYPE 1108-A
COUPLING PANEL



USES: This coupling panel is designed specifically for use as the centralized control panel in a frequency-measuring equipment employing a TYPE 1100-AP Primary Frequency Standard (or TYPE 1100-AQ Secondary Frequency Standard). The panel carries the necessary switches and volume controls for all frequency-measurement operations.

DESCRIPTION: The instrument contains the following controls: FREQUENCY METER, for selecting and combining the frequency meter outputs of 1106-A, 1106-B and 1106-C

heterodyne frequency meter sections; STANDARD FREQUENCY HARMONIC selector, selecting 100-kc or 10-kc harmonic outputs, or combination; individual volume controls; DETECTOR selector, for selecting input and output circuits of 1106-A, 1106-B, 1106-C, or an external detector (or receiver); an ON-OFF switch and volume control for frequency being measured; MICRODIAL switch; TEL-SPEAKER switch for transferring between telephones and speaker and between detector and interpolator outputs.

SPECIFICATIONS

Terminals: At rear: by 24 shielded coaxial connectors to all sources and instruments required; rear telephone connection for use when adjusting standard against standard-frequency transmissions. At front: by shielded coaxial connectors, harmonic output circuits of 1106-A, 1106-B, and 1106-C heterodyne frequency meter sections; input connection for frequency being measured;

by two-point or standard telephone jack, connections for telephone receivers.

Mounting: Standard 19-inch relay-rack mounting; dress panel construction; crackle finish.

Dimensions: Panel (length) 19 × (height) 7 inches; depth behind panel, 6½ inches.

Net Weight: 16 pounds.

Type		Code Word	Price
1108-A	Coupling Panel.....	BATTY	\$305.00

PATENT NOTICE. See Note 4, page x.





TYPE 1109-A COMPARISON OSCILLOSCOPE



USES: This instrument is particularly intended for use with a TYPE 1100-AP Primary Frequency Standard (or TYPE 1100-AQ Secondary Frequency Standard) as an aid in making interpolations or checking calibrations with high accuracy. With such standards and associated measuring equipment, the TYPE 1109-A Comparison Oscilloscope provides a convenient means of measuring audio and carrier frequencies or of calibrating oscillators in these frequency ranges.

DESCRIPTION: The TYPE 1109-A Comparison Oscilloscope contains a 3-inch, radial-deflection cathode-ray tube and its power supply. Selective amplifiers with power supply, phase-shift networks, and controls are provided for obtaining circular sweeps at the power line frequency, at 0.1, 1, and 10 kc from the frequency standard, and at variable frequency obtained from the TYPE 1107-A Interpolation Oscillator. A radial deflection amplifier is provided, for displaying the input signal on

the circular sweep base. Switching is provided for selecting the sweep frequencies and for selecting any one of the several operations normally involved in making frequency measurements or calibrations.

FEATURES:

- The general use of circular sweeps provides symmetrical and readily interpreted patterns.
- By overloading the deflection amplifier the operator can identify easily frequency ratios involving much higher integers than can be identified in Lissajous patterns.
- Ordinarily in the use of calibrated oscillators, it is not necessary to identify a pattern; it is only necessary to adjust the oscillator so that the pattern stands still. A system of known frequencies is easily established on the basis of the *type* of pattern obtained. When used on base frequencies 10 or 100 times higher, the *same types* of pattern correspond to frequencies just 10 or 100 times higher than the original system of known frequencies.

SPECIFICATIONS

Frequency Range: Useful patterns can be obtained over the frequency range from very low audio frequencies to radio frequencies of a few hundred kilocycles. In the range up to 100 kilocycles, an input voltage of 0.5 volt gives full radial deflection. Larger voltages give very useful square-wave radial deflections.

Controls: ON-OFF switch; BRILLIANCE, FOCUS, and CENTERING adjustments for cathode-ray tube; sweep DIAMETER, and SHAPING controls; FREQUENCY selector for circular sweep; SELECTOR for sources to be compared.

Terminals: At rear, by coaxial connectors for standard frequencies and for sources to be compared; on panel by universal two-point and coaxial connector to source being measured or calibrated (0 to 100 kc or more).

Power Supply: 105 to 125 (or 210 to 250) volts, 50-60 cycles. Other voltages or frequencies on special order only.

Power input receptacle will accept either 2-wire (TYPE CAP-35) or 3-wire (TYPE CAP-15) power cord. Two-wire cord is supplied, unless instrument is a part of TYPE 1105-A assembly. For 3-wire, see page 237.

Power Input: 30 watts, approximately.

Tube Complement: 1—TYPE 3DP1A, 3" radial deflection Cathode-Ray Oscilloscope
 2—6SN7GT 1—2X2A 1—6X5-GT
 1—6J5GT 1—6SJ7

Accessories Supplied: Spare fuses; TYPE CAP-35 Power Cord; five TYPE 874-C62 Coaxial Connectors (if instrument is not a part of TYPE 1105-A assembly); one TYPE 274-MB Double Plug.

Mounting: Standard 19-inch relay-rack mounting; dress panel construction; crackle finish.

Dimensions: Panel (length) 19 × (height) 7 inches; behind panel, (width) 17¼ × (height) 6¾ × (depth) 12½ inches.
Net Weight: 35 pounds.

Type	Code Word	Price
1109-A Comparison Oscilloscope.....	BASIN	\$545.00

PATENT NOTICE. See Note 4, page x.



STANDARD-FREQUENCY MULTIPLIERS



Type 1112-A
1, 10, 100 Mc

USES: The TYPE 1112 Standard-Frequency Multipliers generate sine-wave signals of 1, 10, 100 and 1000 megacycles per second when driven from a 100-kc or 1-Mc source. Alternatively they can be driven from a source of 2.5 or 5 Mc, in which case the 1-Mc output is inoperative. Thus, they greatly extend the useful range of conventional crystal-controlled frequency standards, such as the General Radio TYPE 1100.

The output frequencies can be used to generate harmonic series, by means of simple crystal multiplier and mixer circuits, to provide standard frequencies throughout the microwave spectrum for the precise measurement of frequency.

The low noise and excellent phase stability of the output frequencies make possible the intercomparison of lower-frequency standard-frequency oscillators for stability measurements, and the comparison of crystal standards with caesium-beam and ammonia types.

DESCRIPTION: The underlying principle on which the phase-stability and noise-reduction properties of these multipliers are based is the use of a narrow-band filter to select only the desired output harmonic at each output frequency.

The filters used in the TYPE 1112-A Multiplier are quartz crystals since they afford the highest possible Q, and hence narrowest bandwidth, in this frequency range. In order to maintain these crystal filters at the correct resonant frequency to pass the desired harmonic, each crystal is incorporated in an oscillator circuit whose frequency is phase

locked to the desired harmonic frequency by an automatic-phase-control loop. As shown in the block diagram, the 100-kc input signal is multiplied to 1, 10, and 100 Mc, each of which is compared in a phase detector to a crystal oscillator of the same nominal frequency. The output of the phase detector corrects the frequency of the oscillator through a reactance tube. The bandwidth of the feedback loop is kept narrow to minimize frequency or phase-modulation noise.

The TYPE 1112-B Standard-Frequency Multiplier operates from the 100-Mc output of the TYPE 1112-A. A phase-locked klystron oscillator is used as a selective filter to eliminate unwanted harmonics of the control frequency, thus operating in much the same manner as the locked crystal oscillators in the lower-frequency unit. The over-all multiplying factor of 10 is obtained by multiplying 3 x 3 and adding 1. Since, however, the Q of the klystron resonator is not extraordinarily high, the phase modulation noise inherent in klystrons is reduced by means of negative feedback. The automatic-phase-control loop for the 1000-Mc klystron feeds back phase noise over a wide frequency band to reduce phase instability, the reference standard in this case being taken as the multiplied harmonic of the crystal-controlled 100-Mc driving signal.

FEATURES:

- Low noise.
- Excellent stability.
- 20 mw output.
- 50-ohm impedance.



Type 1112-B 1000 Mc



SPECIFICATIONS

Type 1112-A Standard-Frequency Multiplier

Spurious Signals: Unwanted harmonics of the input frequency are at least 100 db below the desired output frequency.

Phase-Modulation Noise: Less than $\pm 1 \times 10^{-9}$ residual noise.

Locking Range: The input signal can drift ± 15 parts per million before the locked oscillator goes out of control.

Bandwidth: (Expressed as allowable frequency deviation rate).

Decade	Approx. Bandwidth in cps at Input Frequency
100 kc - 1 Mc	10
1 Mc - 10 Mc	100
10 Mc - 100 Mc	1000

Input: 1 volt, 100-kc sine wave from standard-frequency oscillator. Can also be driven at input frequencies of 1, 2.5, and 5 Mc. Required input is approximately 5 volts. Will run free with no input signal, but absolute frequency will be in error by several parts per million unless standardized.

Output: Four channels; one each of 1 Mc and 10 Mc, and

two of 100 Mc; all sine wave; all 50 ohms; 20 milliwatts, max., into 50 ohms.

Terminals: TYPE 874 Coaxial Connectors; adaptors are available to fit all commonly used connector types.

Power Supply: 105 to 125 (or 210 to 250) volts, 50 to 60 cycles, 100 watts. Power input receptacle will accept either 2-wire (TYPE CAP-35) or 3-wire (TYPE CAP-15) power cord. TYPE CAP-35 2-wire cord is furnished. For 3-wire cord, see page 237.

Mounting and Dimensions: Relay-rack panel, 19 x 12 1/4 inches; over-all depth, 11 1/2 inches.

Net Weight: 25 pounds.

Type 1112-B Standard-Frequency Multiplier

Input: 20 milliwatts, 100 Mc, sine wave from TYPE 1112-A Standard-Frequency Multiplier; 50-ohm input impedance. **Output:** 1000-Mc sine wave; 50 mw into 50-ohm load; 50-ohm output impedance.

Locking Range: ± 100 kc at the input frequency.

Bandwidth: Allowable frequency deviation rate is 100,000 cycles at the input frequency.

Net Weight: 35 pounds.

Other specifications are identical with those for TYPE 1112-A, above.

Type	Code Word	Price
1112-A Standard-Frequency Multiplier.....	EPOCH	\$1450.00
1112-B Standard-Frequency Multiplier.....	EPODE	1360.00

PATENT NOTICE. See Notes 2, 4, and 8, page x.

For a complete description of these instruments, see the *General Radio Experimenter*, Vol. 32, No. 10, March, 1958.

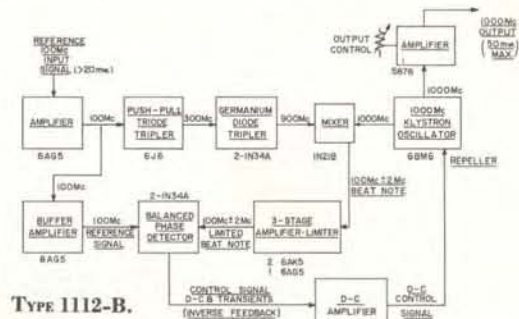
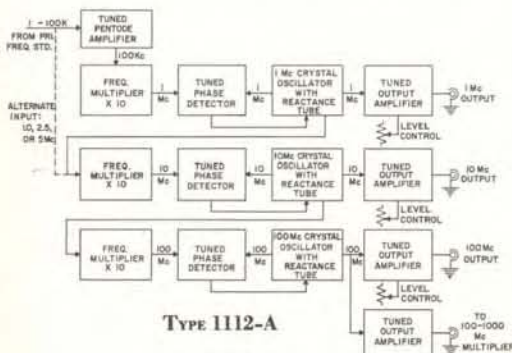

TYPE 1213-C UNIT TIME/FREQUENCY CALIBRATOR



USES: The TYPE 1213-C Time/Frequency Calibrator is a compact, inexpensive, secondary standard of frequency containing in a single package the circuits necessary for calibration operations that have hitherto required several instruments. These circuits include: (1) a crystal-controlled source of harmonics at multiples of 10 Mc, 1 Mc, 100 kc and 10 kc, (2) a heterodyne detector and beat amplifier, and (3) a pulse amplifier.

The standard-frequency harmonics are useful for receiver calibration and frequency measurement with external detectors and interpolating equipment. The self-contained mixer and audio amplifier permit calibration of oscillators without requiring any additional equipment.

The crystal oscillator can be standardized by adjustment to zero beat with standard-frequency radio transmissions from WWV or other stations.

With auxiliary Unit Oscillators for interpolation and an oscilloscope for zero-beat indications, this calibrator can measure accurately all the frequencies of radio broadcast and television transmitters. A technical paper on the subject is available on request.

Separate binding posts on the front panel make available the output signals from the cathode-follower pulse amplifier for use in oscilloscopic time calibration or pulse trigger applications. The output can be differentiated in the TYPE 1213-P1 Differentiator to provide time-mark pulses at intervals of 0.1 μ sec, 1.0 μ sec, 10 μ sec and 100 μ sec for calibrating

variable time delay units and oscilloscopes. The amplitude of the pulses is sufficient to trigger pulse-generating equipment and oscilloscope sweeps.

DESCRIPTION: The crystal oscillator uses a 5-Mc AT-cut, hermetically-sealed quartz plate and is electron coupled to a 2:1 multiplier, followed by a buffer stage. The 10-Mc buffer drives a series of multivibrators with fundamentals of 1 Mc, 100 kc, and 10 Kc. Their outputs can be switched to drive either a harmonic generator or video amplifier. The harmonic generator feeds a crystal mixer and an r-f output connector. For harmonic calibration with the mixer, the video amplifier is switched to act as a high-gain audio amplifier at the mixer output. For oscilloscopic time calibration, the video amplifier supplies pulses at binding-post terminals.

A narrow-range frequency adjustment is provided for setting the crystal oscillator to zero beat with standard-frequency radio transmissions or other external standards. A touch-button deviator is provided to introduce a small frequency decrease for establishing "sense" in indications near zero-beat.

FEATURES:

- Wide range of output frequencies.
- Easily standardized against WWV standard-frequency transmissions.
- Accurate timing source for oscilloscopes.
- Compact unit construction.
- Internal mixer for maximum utility.

SPECIFICATIONS

Output Frequencies: 10 Mc, 1 Mc, 100 kc, 10 kc.
Output Amplitudes: 10 Mc, 7v peak-to-peak, 30 volts peak-to-peak at lower output frequencies from pulse

amplifier; r-f harmonics usable to 1000 Mc from 10-Mc output, to 500 Mc from 1-Mc output, to 100 Mc from 100-Kc output, and to 10 Mc from 10-kc output.



Output Impedance: Video cathode-follower 300 ohms; r-f output obtained from crystal-diode harmonic generator.

Stability: After 40 minutes warm-up, drift rate with regulated plate supply is mainly the drift rate of the quartz crystal (approx 1 ppm/°C). With unregulated power supply, an additional variation of $\pm \frac{1}{2}$ ppm with line voltage change from 105 to 125 volts.

Sensitivity: Usable beat notes can be produced with 50 millivolts signal input to mixer over the harmonic ranges specified under "Output Amplitudes."

Tube Complement: 1-6BE6, 1-5687, 2-5964, 1-6AK6, 1-6AN8, 1-6U8.

Power Supply: 6.3 v ac, 3.0 amps; 300 v dc, 50 ma. TYPE 1203-B or TYPE 1201-B; for best frequency stability, TYPE 1201-B is recommended. See page 142.

Accessories Supplied: TYPE 1213-P1 Differentiator, one coaxial connector, and one multi-point connector.

Mounting: Aluminum panel and sides, finished in crackle; aluminum cover, finished in clear lacquer. Relay rack panel is available for mounting both calibrator and power supply.

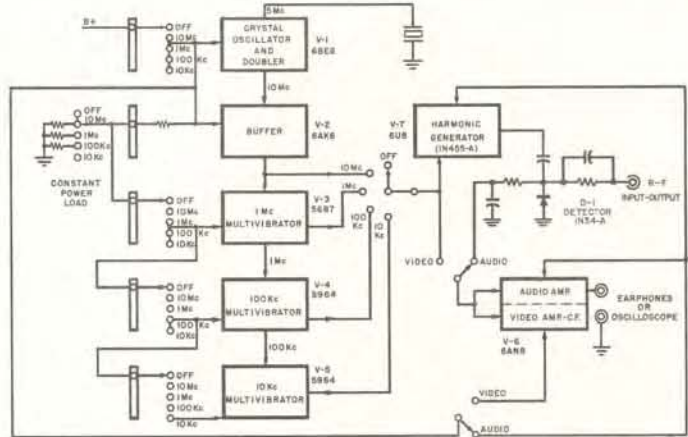

Block diagram of the Type 1213-C Unit Time/Frequency Calibrator, showing the basic circuits.

Dimensions: 10½ (width) × 5¾ (height) × 7 (depth) inches, overall. **Net Weight:** 4 lbs, 10 oz.

Type		Code Word	Price
1213-C	Unit Time/Frequency Calibrator*	REBEL	\$260.00
1201-B	Unit Regulated Power Supply	ASSET	85.00
480-P4U3	Relay-rack panel (7-inch) (for mounting both calibrator and power supply)	UNIPANCART	10.85

*PATENT NOTICE. See Note 4, page x.

TYPE 720-A HETERODYNE FREQUENCY METER

USES: The TYPE 720-A Heterodyne Frequency Meter is used for accurate frequency measurements from 10 to 3000 megacycles. It can be used as a calibrated frequency meter or as a transfer oscillator with the TYPE 1100-A Frequency Standard and the TYPE 1105-A Frequency Measuring Equipment.

DESCRIPTION: The principal elements of the instrument are a calibrated oscillator, a crystal detector, and a three-stage wide-band amplifier. The instrument uses the General-Radio-developed butterfly circuit, which allows simultaneous variation of inductance and capacitance in the oscillator circuit without sliding contacts. This permits smooth, stable, and continuous adjustment of frequency. The oscillator tunes from 100 to 200 megacycles and produces usable harmonics up to 3000 megacycles. For measurements below 100 megacycles, harmonics of the unknown are used.

The entire assembly is battery-operated, completely self-contained, and mounted in a portable, fabric-covered cabinet. An a-c power supply to fit the battery compartment is also available.



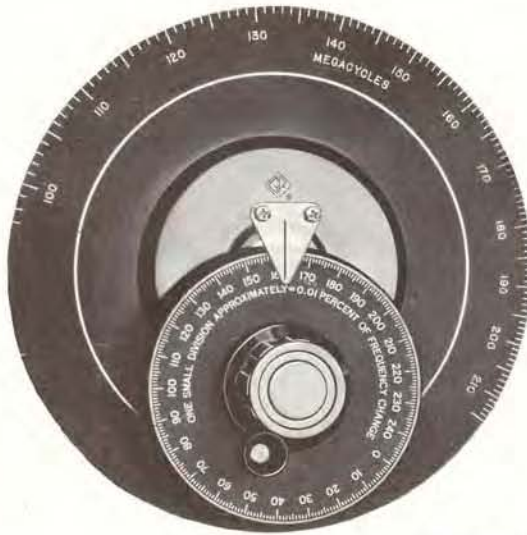

FEATURES:

- No direct connection to the source under measurement is usually required, because of the high sensitivity and the adjustable antenna mounted on the panel.
- A wide range of frequencies can be measured: 10 to 3000 megacycles.
- Detector has 50-kc bandwidth.
- The dial arrangement allows small frequency increments to be measured precisely.
- The butterfly type of tuned circuit eliminates all sliding contact difficulties.
- Provision for either visual or aural zero beat indication.
- Either batteries or an a-c power supply can be used. This makes the instrument well suited for both field and laboratory use.

SPECIFICATIONS

Frequency Range: 100 to 200 megacycles on fundamentals, 10 to 3000 megacycles on harmonics.

Beat Indication: With strong signals beat notes can be heard through a small dynamic speaker on the front panel. A visual indication can be obtained from the panel meter. A jack is provided for headphones and is located on the front panel.

Band Width: The three-stage amplifier has an effective band width of 50 kc, so that a visual indication can be obtained, even when the frequency under measurement is not stable enough to produce a steady audio beat.

Calibration: The main dial is calibrated in one-megacycle divisions.

The slow-motion drive is geared to the tuning unit, and its dial carries 250 uniform divisions. Each one of these divisions corresponds to a frequency change of approximately 0.01%.

Accuracy: The over-all accuracy of measurement is $\pm 0.1\%$. For measurements requiring greater accuracy, the frequency meter can be used with the TYPE 1100-A Frequency Standard and the TYPE 1105-A Frequency Measuring Equipment.

Temperature and Humidity Effects: Over the range of room conditions normally encountered, temperature and hu-

midity do not affect the accuracy of the instrument.

Input Terminal: A short adjustable rod serves as antenna to pick up the unknown signal. Additional length of wire can be attached.

Tube Complement: One each 1N5-GT/G, 1D8-GT, CK-5676.

Power Supply: A Burgess 6TA60 Battery is supplied with the instrument. For a-c operation the TYPE 1261-A Power Supply can be used (see page 145) but must be ordered separately.

Mounting: The TYPE 720-A Heterodyne Frequency Meter is mounted in a shielded carrying case of durable airplane-luggage construction. Complete operating instructions are attached to the cover, and a complete wiring diagram, with circuit constants, is attached to the inside of the cabinet.

Accessories Supplied: One 1N21-B Crystal is supplied as a spare in addition to the one in the instrument.

Accessories Recommended: Headphones which can be plugged in on the front panel, and which can be stored in the cover of the instrument.

Dimensions: (Height) 14 x (width) 12½ x (depth) 10½ inches, over-all, including cover and handle. Panel, 10¾ x 11¾ inches.

Net Weight: 27½ pounds, with battery.

Type		Code Word	Price
720-A	Heterodyne Frequency Meter*	FANCY	\$455.00
1261-A	A-C Power Supply.....	NUTTY	128.00

*PATENT NOTICE. See Note 10, page x.

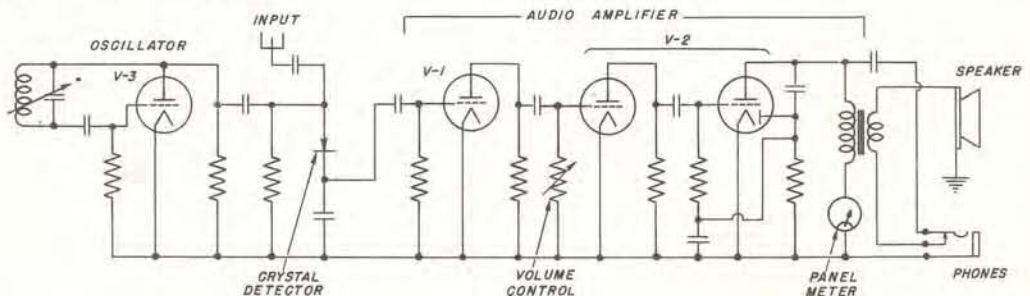

STANDARD-SIGNAL GENERATORS



A standard-signal generator is a source of alternating current energy of accurately known characteristics. The carrier or center frequency is indicated by a dial setting, the output voltage by a meter reading and associated attenuator setting, and the modulation by a meter reading set by appropriate control knobs. Common types of modulation signals are sine-wave, square-wave and pulse; the output signal may be either frequency- or amplitude-modulated by these signals. When the fm modulating system produces a considerable excursion in frequency at a relatively low cyclical rate, the instrument is known as a sweep generator and is particularly useful for automatic data display. Standard-signal generators are used for testing radio receivers, as voltage standards over the range from a few microvolts to about a volt, and generally as power sources in the measurement of gain, bandwidth, signal-to-noise ratios, standing-wave ratios, and other circuit properties.

The elements of a standard-signal generator are shown in Figure 1. A buffer amplifier is sometimes added to reduce incidental frequency modulation. The requirements for the oscillator are that it be stable, that it have reasonably constant output over any one frequency range, that the waveform be good, and that hum and noise modulation be negligible. Over-all shielding of the generator is also necessary to minimize stray fields.

General Radio standard-signal generators are well-shielded, general-purpose instruments, which cover frequencies from 5 kilocycles per second to 920 megacycles per second, a frequency span of 184,000:1.

Internal amplitude (sine-wave) modulation is provided at one or more fixed frequencies. Various types of external modulation can also be applied.

(1) Provision is made for modulation over the entire audio-frequency range from an external source.

(2) Amplitude modulation in signal generation is generally accompanied by some incidental frequency modulation. This can be substantially eliminated, at low cost, by the use of external crystal-diode absorption modulators, which also make possible modulation at video frequencies and high quality pulse modulation.

The TYPE 1000-P6 Crystal Diode Modulator consists of a crystal diode connected between the input and output terminals with means for applying bias and modulating voltages to the crystal. It can be used at carrier frequencies between 20 and 1000 megacycles and can produce up to 30% amplitude modulation from 0 to 5 megacycles. The maximum output of the TYPE 1000-P6 Crystal Diode Modulator is approximately 10 millivolts.

The TYPE 1000-P7 Balanced Modulator is similar but suppresses carrier leakage to a considerably greater extent. It consists of two crystal diodes, a tunable section of coaxial line between input and output terminals, and associated circuits for applying bias and modulating voltages. It is designed for use at carrier frequencies from 60 to 2300 megacycles and can produce linear 100% amplitude modulation and pulse modulation with fast rise time and with a high on-off ratio.

(3) For sweeping, the TYPE 1750-A Sweep Drive is recommended. This mechanical device is used to sweep carrier frequency back and forth over a narrow range, in order to plot or to display the amplitude-vs.-frequency characteristics of components and networks. The shaft of the sweep drive is connected by a flexible coupling to the shaft of the frequency-determining element in the radio-frequency oscillator as indicated schematically in Figure 2. Reciprocating rotation up to 300 degrees can be imparted at rates of 1 per second. The corresponding percentage variation in frequency is listed for each one of the General Radio Signal Generators.

STANDARD-SIGNAL GENERATORS

Type	Frequency Range	Open-Circuit Voltage	Output Impedance	Modulation %	Page
1021-AV	40-250 Mc	0.5 μ v-1v	50 Ω	0-50%	90
1021-AU	250-920 Mc	0.5 μ v-1v	50 Ω	0-50%	90
1001-A	5 kc-50 Mc	0.1 μ v-200 mv	10 Ω , 50 Ω	0-80%	92
805-C	16 kc-50 Mc	0.2 μ v-4v	37.5 Ω	0-100%	94

MODULATORS

Type	Carrier Range	Modulation Frequency Range	Modulation %	Page
1000-P6	20-1000 Mc	0-5 Mc	0-30%	97
1000-P7	60-2300 Mc	0-20 Mc	0-100%	98

ACCESSORIES

Type		Page
1000-P3	100:1 Voltage Divider	96
1000-P4	Dummy Antenna	96
1000-P5	VHF Transformer (50 ohms, grounded, to 300 ohms, bal.)	96
1000-P10	Test Loop	96

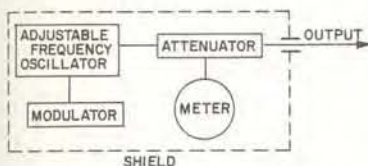

FIGURE 1. Elements of a standard-signal generator.

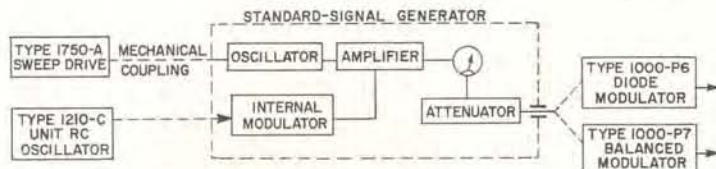

FIGURE 2. Modulation methods.





TYPE 1021 STANDARD-SIGNAL GENERATORS

40 TO 920 MEGACYCLES IN TWO MODELS

USES: These Standard-Signal Generators are as reliable and as convenient at very-high and ultra-high frequencies as conventional standard-signal generators are at much lower frequencies. Their uses include the determination of radio-receiver and amplifier characteristics in the engineering laboratory and in production as well as the supply of v-h-f and u-h-f power for bridges, slotted lines, and other measuring devices.

The simple TYPE 1000-P6 Crystal-Diode Modulator and a source of video signals, such as a standard television receiver tuned to a local television station, can be used to produce television picture modulation of the signal generator output on all v-h-f and u-h-f channels.

With the TYPE 1000-P7 Balanced Modulator, up to 100% amplitude modulation and pulsing with very low residual carrier level are possible at frequencies above 60 Mc.

The frequency can be swept over a range of about 10% by means of the TYPE 1750-A Sweep Drive, which can be attached to the slow-motion dial.

DESCRIPTION: Each TYPE 1021 Standard-

Signal Generator is a compact and lightweight instrument of simple, rugged, durable design. For flexibility and economy, each signal generator is made up of two units mounted in a single cabinet. The power supply, modulator, and metering system make up one unit, the TYPE 1021-P1 Power Supply, which occupies the left-hand side of the welded aluminum cabinet. The right-hand side of the cabinet houses either of the readily interchangeable carrier-oscillator units: The TYPE 1021-P2 U-H-F Unit (250 to 920 Mc.) or the TYPE 1021-P3B/V-H-F Unit (40 to 250 Mc.)

As noted in the price table, individual tuning units can be furnished for use with one common power supply and cabinet assembly. A storage case for unused oscillator unit is available. Power supply and cabinet assembly can also be purchased separately.

These generators have provisions for external and 1000-cycle sine-wave internal amplitude modulation.

The frequency-determining elements are butterfly circuits. A mutual-inductance-type attenuator with a dial calibrated in both voltage and db is used.

**FEATURES:**

- Wide frequency coverage in single dial range.
- Easy to operate.
- High output.
- Accurately known output voltage, frequency, and impedance.

- Auxiliary db calibration in terms of maximum power available.
- Good stability and low drift.
- Very well shielded.
- A wide variety of coaxial accessories is available (see pages 41 to 58).
- VHF and UHF oscillator units are easily interchangeable.

SPECIFICATIONS**TYPE 1021-AU U-H-F STANDARD-SIGNAL GENERATOR**

Carrier Frequency Range: 250 Mc to 920 Mc in one band.
Frequency Calibration: Direct reading to $\pm 1\%$. Approximately 8 turns of the 100-division slow-motion dial cover the range of the main dial.

Sweeping: The TYPE 1750-A Sweep Drive attached to the slow-motion dial will sweep approximately 5% and 15% at the low- and high-frequency ends of the range, respectively.

Output Calibration: (1) As voltage generator with accurately known output impedance and (2) in terms of maximum power available.

Output Voltage: Continuously adjustable from 0.5 microvolt to 1 volt behind 50 ohms.

Output Power: Continuously adjustable from 0 to 126 db below 1 milliwatt into 50 ohms.

Output Impedance: 50 ohms $\pm 10\%$.

Output Voltage Accuracy: Over-all accuracy of output is better than ± 2 db. The accuracy of voltmeter calibration between 0.5 and 1.0 volt is better than ± 1 db. The accuracy of the attenuator-dial calibration for voltages between 1.0 microvolt and 0.1 volt is better than ± 0.5 db; from 0.1 volt to 0.5 volt, better than ± 1 db. At 920 megacycles the resonance error in the voltmeter is $+0.5$ db.

Amplitude Modulation: Adjustable, 0 to 50%. Internal, 1000 c $\pm 5\%$. External, flat within 3 db from 30 c to 15 kc. For 50% modulation, external audio oscillator must supply 18 volts across a 100-kilohm load. TYPE 1210-C Unit R-C Oscillator is recommended.

Envelope Distortion: Less than 5% at 50% modulation.

Noise Level: Carrier noise level corresponds to about 0.2% modulation.

Incidental Frequency Modulation: For 50% amplitude modulation the incidental fm is approximately 100

parts per million for frequencies up to 400 Mc and is approximately 1000 parts per million at 920 Mc. When lower values of incidental fm are required, the TYPE 1000-P6 Crystal Modulator, or the TYPE 1000-P7 Balanced Modulator (pages 97 and 98) is recommended.

Leakage: Stray fields and residual output voltage are sufficiently low for measurements on receivers of one-microvolt sensitivity.

Terminals: TYPE 874 Coaxial Terminals are provided for the output connection.

Power Supply: 105 to 125 (or 210 to 250) volts, 50 to 60 cycles. Power input is approximately 50 watts at 115 volts.

This instrument will operate satisfactorily on power-supply frequencies up to 400 cycles, provided that the supply voltage is between 110 and 125 volts.

Power input receptacle will accept either 2-wire (TYPE CAP-35) or 3-wire (TYPE CAP-15) power cord. Two-wire cord is supplied. For 3-wire, see page 237.
Tube Complement: Two 0C3; one each 6X5-GT/G, 6K6-GT, Sylvania TYPE RT-434, Amperite 6-4.

Accessories Supplied: TYPE 874-R22 Patch Cord, TYPE 874-PB58 Panel Connector, TYPE 874-C58 Cable Connector, TYPE CAP-35 Power Cord, and spare fuses.

Other Accessories Available: TYPE 874-G10 and -G20 Fixed Attenuators, TYPE 874 Coaxial Elements (pages 41 to 58), TYPE 1000-P6 Crystal Modulator, TYPE 1000-P7 Balanced Modulator (pages 97 and 98).

Mounting: The aluminum cabinet has a wrinkle finish. The left-hand side houses the TYPE 1021-P1 Power Supply; the right-hand side houses the TYPE 1021-P2 U-H-F Unit. Panels are crackle-finished aluminum.

Dimensions: (Height) $14\frac{3}{8}$ x (width) $20\frac{1}{4}$ x (depth) $10\frac{1}{16}$ inches, over-all.

Net Weight: 37 $\frac{1}{2}$ pounds.

TYPE 1021-AV V-H-F STANDARD-SIGNAL GENERATOR

Same as TYPE 1021-AU (above) except as noted.

Carrier Frequency Range: 40 to 50 Mc in one band, 50-250 in another.

Incidental Frequency Modulation: For 50% amplitude modulation the incidental fm is approximately 100 parts per million for frequencies up to 100 Mc, and is approximately 500 parts per million at 250 Mc. When lower values of incidental fm are required, the TYPE 1000-P6 Crystal Modulator or the TYPE 1000-P7 Balanced Modulator (pages 97 and 98) is recommended.

Sweeping: The TYPE 1750-A Sweep Drive, attached to the slow-motion dial will sweep the frequency approximately 4, 9, and 20% at 40, 50, and 250 Mc, respectively.

Tube Complement: 12AT7 (Oscillator instead of RT-434). Other tubes as listed above.

Mounting: Cabinet is same as for TYPE 1021-AU, above. Generator consists of the TYPE 1021-P1 Power Supply and TYPE 1021-P3B V-H-F Unit.

Type		Code Word	Price
1021-AU	U-H-F Standard-Signal Generator, 250-920 Mc	EVADE	\$700.00
1021-AV	V-H-F Standard-Signal Generator, 40-250 Mc.....	EVENT	710.00
1021-P2	U-H-F Oscillator Unit* only, 250-920 Mc	ETHIC	420.00
1021-P3B	V-H-F Oscillator Unit* only, 40-250 Mc.....	EVOKE	430.00
1021-P1	Power Supply and cabinet assembly	EXTRA	280.00
1021-P10	Storage case for oscillator unit	BOXEY	18.00

PATENT NOTICE. See Notes 4 and 10, page x.

*Less power supply unit and cabinet. Can replace oscillator unit in any signal generator listed above, to provide additional frequency range.





TYPE 1001-A STANDARD-SIGNAL GENERATOR

USES: The TYPE 1001-A Standard-Signal Generator is a laboratory instrument for use in determining the performance of receivers and other equipment at ultrasonic and radio frequencies. Its sturdy construction and simplicity of operation make it suitable for production testing. Because of its small size, low weight, and low power consumption, it can be adapted for use in field-strength measurements.

With the TYPE 1000-P6 Crystal Diode Modulator, the generator output can be modulated at video frequencies for testing television i-f circuits.

The frequency can be swept over a maximum range of 14% by the TYPE 1750-A Sweep Drive, which attaches to the slow-motion dial.

DESCRIPTION: The welded aluminum cabinet of the TYPE 1001-A Standard-Signal Generator houses three separate groups of circuits. The power supply is at the top, the completely shielded radio-frequency portion in the middle, and the modulation and control circuits at the bottom.

The Hartley-type carrier-frequency oscillator covers in eight ranges the frequency spectrum from 5 kc to 50 Mc. The plates of the main tuning capacitor are shaped to give a logarithmic variation of frequency with angular rotation. The precision of frequency set-

ting, therefore, is constant, and the vernier dial is calibrated directly in percentage frequency increments.

A buffer amplifier is used between the oscillator and the low-impedance output circuits. The amplifier is grid modulated to provide amplitude modulation from 0 to 80 percent. Loose coupling between the oscillator and the amplifier minimizes incidental frequency modulation. The attenuator system and the output meter are coupled to the amplifier through a high-pass filter, which reduces voltages of the modulation frequency in the output.

The output voltage is determined by establishing a fixed carrier level at the attenuator input and by setting two attenuator controls. The carrier level is set by adjusting the plate-supply voltage of the oscillator and is indicated by a vacuum-tube voltmeter at the attenuator input. The attenuator system consists of a continuously adjustable L-network controlled by the output dial and a decade ladder-network attenuator.

The modulation circuits include a 400-cycle R-C oscillator for internal modulation and a germanium-crystal rectifier to determine modulation percentage. Percentage modulation is read on the same panel meter that indicates the carrier output level.

**FEATURES:**

- Output cable termination can be removed for matching into a 50-ohm system.
- Very low residual output and stray field.
- A periodic output amplifier avoids sideband cutting and minimizes reaction of attenuator setting or load on carrier frequency.

SPECIFICATIONS

Carrier-Frequency Range: 5 kilocycles to 50 megacycles covered in eight direct-reading ranges: 5 to 15 kc, 15 to 50 kc, 50 to 150 kc, 150 to 500 kc, 0.5 to 1.5 Mc, 1.5 to 5 Mc, 5 to 15 Mc, and 15 to 50 Mc.

Frequency Calibration: Logarithmic up to 15 Mc, departing slightly from the logarithmic scale at higher frequencies. Accuracy, $\pm 1\%$.

Incremental-Frequency Dial: Frequency increment is 0.1% per dial division, at frequencies up to 15 Mc.

Sweeping: Maximum sweep range with the TYPE 1750-A Sweep Drive is 14%.

Frequency Stability: Warm-up drift is of the order of 0.25%. Half the maximum drift is reached in 1½ hours.

Output Voltage Range: Open-circuit output voltage at the attenuator jack is continuously adjustable from 0.1 microvolt to 200 millivolts. With output cable terminated at both ends, output voltage is continuously adjustable from 0.05 microvolt to 100 millivolts. Open-circuit output voltage at the 2 VOLTS panel jack is measured directly by the output meter and is 2 volts if the meter is set to the reference mark. This voltage is available up to at least 15 Mc.

Output Impedance: Output impedance at the attenuator jack is 10 ohms (50 ohms when the series unit is used) except for the highest output position of the attenuator, where it is 50 ohms.

Output impedance at the end of the terminated cable is 25 ohms. Output impedance at the 2 VOLTS panel jack is 300 ohms.

An output impedance of one ohm (with output voltage reduced 100:1) can be obtained with the TYPE 1000-P3 Voltage Divider, a standard (IRE) test impedance with the TYPE 1000-P4 Dummy Antenna, and a known induction field for testing loop receivers with the TYPE 1000-P10 Test Loop.

Accuracy of Output Voltages: At frequencies below 10 Mc, when the output dial is set near full scale or one-tenth full scale, the output voltage is correctly indicated to $\pm (6\% + 0.1 \mu\text{v})$. With the output dial set in the mid-scale region, the error may be greater by 4%. At frequencies above 10 Mc, when the output dial is set near full scale, the output voltage is correctly indicated to an accuracy of $\pm (10\% + 0.3 \mu\text{v})$ and the error may be as much as 10% larger or smaller at other output dial settings.

The accuracy of the open-circuit output voltages at the 2 VOLTS panel jack is $\pm 3\%$ up to 15 megacycles.

Amplitude Modulation: Adjustable from zero to 80%. Modulation percentage is indicated on the panel meter and is accurate within $\pm 10\%$ of the indicated value, with a possible additional error of 2% in modulation level.

The internal modulation frequency is 400 cycles $\pm 5\%$.

The external modulation characteristic is flat within ± 1 decibel from 20 cycles to 15 kilocycles. To provide

➤ High stability and low drift are assured by high-quality components, low power consumption, and stabilized power supply.

➤ Simplicity of design and construction has resulted in an unusually sturdy instrument of small size, low weight, and long life.

80% modulation, the external audio oscillator must supply 12 volts into a 4000-ohm load (36 milliwatts).

Incidental Frequency Modulation: At 80% amplitude modulation, the incidental frequency modulation varies from 30 to 300 parts per million over each carrier-frequency range except for the highest frequency range (15 to 50 Mc) where it may be three times as great. At lower modulation percentages, frequency modulation is approximately proportional to modulation percentage.

For applications above 20 Mc, where incidental frequency modulation must be very low, the use of the TYPE 1000-P6 Crystal Diode Modulator (page 97) is recommended.

Carrier Distortion: Of the order of 7% on all except the lowest range, where it may increase to 15%.

Envelope Distortion: Less than 8% at 80% amplitude modulation.

Noise Level: Carrier noise level corresponds to about 0.1% modulation.

Leakage: Stray fields at 1 Mc are less than one microvolt per meter two feet from the generator.

Terminals: TYPE 874 Coaxial Terminals are provided for the attenuator output and for the constant 2-volt output.

Power Supply: 105 to 125 (or 210 to 250) volts, 40 to 60 cycles. Power input is approximately 65 watts at 115 volts.

This instrument will also operate satisfactorily on power supply frequencies up to 400 cycles, provided that the supply voltage is at least 115 volts.

Power input receptacle will accept either 2-wire (TYPE CAP-35) or 3-wire (TYPE CAP-15) power cord. Two-wire cord is supplied. For 3-wire, see page 237.

Tube Complement:

1—6C4	1—6AL5	2—0C3
1—6L6	1—5Y3-GT	1—6SN7-GT

Accessories Supplied: TYPE 874-R22 3-foot Coaxial Cable, TYPE 1000-P1 50-Ohm Termination Unit, TYPE 1000-P2 40-Ohm Series Unit, TYPE 874-Q2 Adaptor, TYPE TO-44 Adjustment Tool (stored in cabinet), TYPE 274-MB Plug, TYPE 874-C58 Cable Connector, TYPE 874-PB58 Panel Connector, spare fuses, and a TYPE CAP-35 Power Cord.

Other Accessories Available: Not supplied but available on order are the TYPE 1000-P3 Voltage Divider, the TYPE 1000-P4 Standard Dummy Antenna, the TYPE 1000-P10 Test Loop, and the TYPE 1000-P6 Crystal Diode Modulator. See pages 96 to 98.

Mounting: The instrument is assembled on an aluminum panel finished in crackle lacquer and mounted in an aluminum cabinet with a wrinkle finish. The cabinet is provided with carrying handles. A recessed compartment is built into the top of the cabinet for storing accessories.

Dimensions: (Height) $14\frac{3}{8}$ x (width) $20\frac{1}{4}$ x (depth) $10\frac{1}{16}$ inches, over-all. **Net Weight:** 54 pounds.

Type		Code Word	Price
1001-A	Standard-Signal Generator	ARGUS	\$860.00

PATENT NOTICE. See Notes 2 and 4, page x.



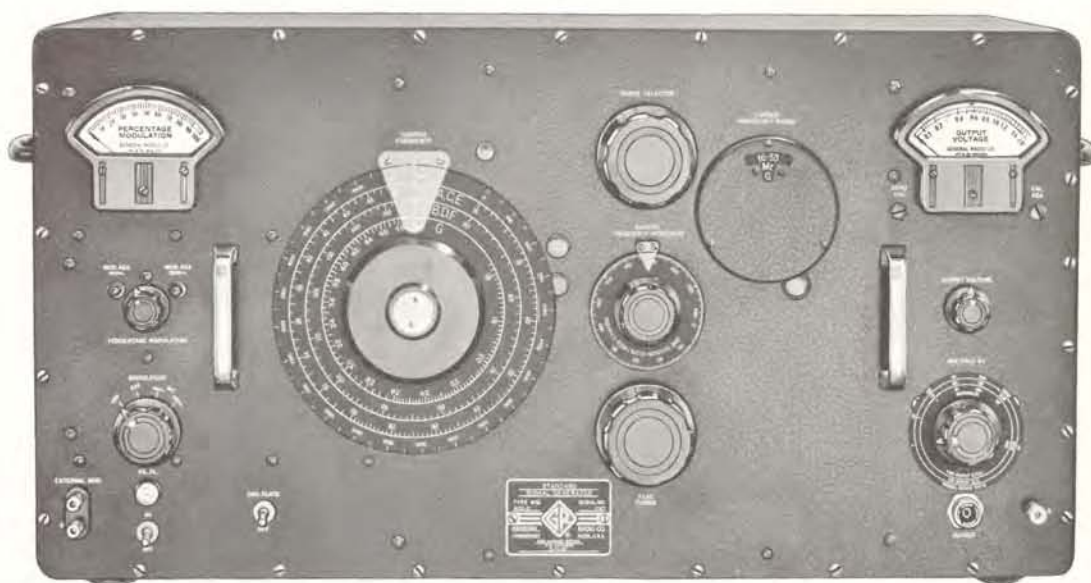

TYPE 805-C STANDARD-SIGNAL GENERATOR

USES: The TYPE 805-C Standard-Signal Generator is designed primarily as a precision laboratory instrument for rapid and accurate testing of radio receivers. Because of its accuracy, wide frequency range, and high voltage output, it is a valuable instrument for laboratories engaged in research and design on radio receivers and allied apparatus, while its speed and simplicity of operation make it well adapted to production testing.

It can be adapted for testing television i-f circuits by the use of a TYPE 1000-P6 Crystal Diode Modulator.

DESCRIPTION: Functionally this instrument consists of (1) a carrier-frequency oscillator, (2) a tuned radio-frequency amplifier, (3) a resistive output attenuator and a voltmeter to read the output level, (4) a modulating oscillator (400 cycles and 1000 cycles) with a voltmeter for reading percentage modulation, and (5) a well-regulated power supply.

The oscillator and amplifier assemblies are virtually identical in construction, and the coil switching assemblies, as well as the tuning capacitors, are ganged and driven from common panel controls. Seven coils covering the frequency range from 16 kc to 50 Mc are carried on a selector disc in each assembly. An eighth coil position is also provided, so that an extra set of coils may be installed if desired. The discs are driven from a panel knob through a gear mechanism, which also brings

into panel view a frequency-range identification dial. As each coil is rotated into position, it is connected into circuit through silver-overlaid contact blades, which firmly engage silver-alloy brushes, mounted on the tuning capacitor. The contacts are mounted on polystyrene strips, insuring both low capacitance and low dielectric losses.

The main tuning capacitors are exceptionally rugged, utilizing the cast frame type of construction, with ball-bearing supports for the rotor. The plates are shaped to give a logarithmic variation of frequency with angular rotation. The two capacitors are driven through a set of gears, which also drive the direct-reading frequency dial.

The output system consists of a vacuum-tube voltmeter, a resistive attenuator network, a 3-foot, 75-ohm output cable, and a terminating unit. This unit terminates the cable in its characteristic impedance. It provides, in addition to the normal output at 37.5 ohms, outputs reduced by factors of 10 and 100, with corresponding output impedances of 7.1 and 0.75 ohms. A standard-broadcast-band dummy-antenna output is also provided.

FEATURES:

- Output voltage continuously variable up to 2 volts, 4 volts open circuit.
- Amplitude modulation up to 100%.





- > Direct-reading incremental-frequency dial with 0.01% frequency change per division.
- > Simplified controls, well suited to production-line testing by relatively unskilled personnel.
- > Tuned amplifier minimizes reaction of out-

- put circuit on carrier frequency.
- > Tuned circuit is heavily damped to prevent side-band clipping.
- > Minimum backlash in gear trains.
- > Regulated power supply eliminates the effects of line-voltage fluctuations.

SPECIFICATIONS

Carrier Frequency Range: 16 kilocycles to 50 megacycles, covered in seven direct-reading ranges: 16 to 50 kc, 50 to 160 kc, 160 to 500 kc, 0.5 to 1.6 Mc, 1.6 to 5.0 Mc, 5.0 to 16 Mc, 16 to 50 Mc. A spare range position is provided so that a special set of coils can be installed if desired.

Frequency Calibration: Each range is direct reading to an accuracy of ±1% of the indicated frequency.

Frequency Drift: Not greater than ±0.1% on any frequency range for a period of 5 hours' continuous operation.

Incremental Frequency Dial: A slow-motion vernier drive dial is provided, by means of which frequency increments as small as 0.01% may be obtained.

Sweeping: Maximum sweep range with the Type 1750-A Sweep Drive is approximately 2%, i.e., ±1% of center frequency. Sweeping is not recommended for continuous or production line use.

Output Voltage Range: Continuously adjustable from 0.1 microvolt to 2 volts. The output voltage (at the termination of the 75-ohm output cable) is indicated by a panel meter and seven-point multiplier. Maximum open-circuit voltage with termination removed is 4 volts.

Output System: The output impedance at the panel jack is 75 ohms resistive. A 75-ohm output cable is provided, together with a termination unit that furnishes constant output impedances of 37.5, 7.1, and 0.75 ohms. The calibration of the panel voltmeter-multiplier combination is in terms of the actual voltage across the 37.5-ohm output. When the 7.1- and 0.75-ohm positions are used, the indicated output voltage must be divided by 10 and 100, respectively. A standard dummy-antenna output is also available at the termination unit.

Output Voltage Accuracy: For multiplier settings below 1 volt the maximum error in output voltage is the sum of the attenuator and voltmeter errors listed below.

Maximum Voltmeter Error: ±5% of indicated reading up to 25 megacycles. Above 25 megacycles, an additional frequency error occurs, amounting to a total of ±7% at 50 megacycles. At 1/2 full scale and 50 Mc, there is also a transit-time error of -5% in the voltmeter tube.

Maximum Attenuator Error:

- Below 3 Mc, = (3% + 0.1 microvolt)
- 3 to 10 Mc, = (5% + 0.2 microvolt)
- 10 to 30 Mc, = (10% + 0.4 microvolt)
- 30 to 50 Mc, = (15% + 0.8 microvolt)

There is no attenuator error for the 1-volt multiplier setting.

Modulation: Continuously variable from 0 to 100%. The percentage of modulation is indicated by a panel meter to an accuracy of ±10% of the meter reading up to 80% for carrier frequencies below 16 Mc; ±15% for higher carrier frequencies.

Internal modulation is available at 400 cycles and 1000

cycles, accurate in frequency within ±5%.

The generator can be modulated by an external oscillator. Approximately 10 volts across 500,000 ohms are required for 80% modulation. The over-all modulation characteristic is as follows:

Carrier Frequency	Audio Range	Level
0.5—50 Mc	50c —15,000c	±1 db
0.1—0.5 Mc	50c —10,000c	±1.5 db
16—100 kc	50c —10% of Carrier Frequency	±1.5 db

Frequency Modulation: On the highest carrier-frequency range the frequency modulation is about 0.05% for 100% modulation, and 0.02% for 30% modulation. At lower carrier frequencies the frequency modulation is less than these percentages.

Above 20 Mc, for applications where incidental fm must be negligible or for wideband (video) modulation, the TYPE 1000-P6 Crystal Diode Modulator should be used.

Distortion and Noise Level: The envelope distortion at a modulation level of 80% is less than 5% at 1 Mc carrier frequency. Carrier noise level is at least 40 db below 80% modulation.

Leakage: The magnetic induction leakage is less than 5 microvolts per meter at a distance of 2 feet from the generator. The 3-foot output cable permits the receiver under test to be kept beyond this limit. Radiation fields are negligible.

Power Supply: 105 to 125 (or 210 to 250) volts, 40 to 60 cycles. An electronic voltage regulator compensates for line-voltage fluctuations from 105 to 125 volts (or from 210 to 250 volts). A maximum input power of 150 watts is required.

Instrument will operate satisfactorily on power-supply frequencies up to 400 cycles, provided that the supply voltage is at least 115 volts.

Power input receptacle will accept either 2-wire (TYPE CAP-35) or 3-wire (TYPE CAP-15) power cord. Two-wire cord is supplied. For 3-wire, see page 237.

Tube Complement:

- 1—6C8-G
- 3—6L6
- 1—5U4-G
- 2—2A3
- 1—6SF5
- 1—0D3
- 1—6AL5
- 1—6H6
- 1—Amperite 3-4

Accessories Supplied: TYPE CAP-35 Power Cord, shielded output cable and termination unit, and spare fuses.

Mounting: The panel is finished in crackle, and the cabinet is wrinkle finish.

Dimensions: (Height) 16 x (width) 33 x (depth) 12 inches, over-all. Net Weight: 117½ pounds.

Type		Code Word	Price
805-C	Standard-Signal Generator	LEPER	\$1750.00

PATENT NOTICE. See Notes 1, 2, and 4, page x.





TYPE 1000-P SIGNAL-GENERATOR ACCESSORIES



TYPE 1000-P3 VOLTAGE DIVIDER

This voltage divider, used with the TYPE 1001-A Standard-Signal Generator, provides a known voltage across a one-ohm resistor, which can be inserted in series with a loop antenna for testing loop receivers.

It plugs into the output jack of the signal generator (TYPE 1001-A) and divides the indicated output voltage by a factor of 100.

Input Impedance: 50 ohms.

Output Impedance: 1 ohm.

Net Weight: 3¼ ounces.

Type	Code Word	Price
1000-P3 100:1 Voltage Divider ...	ARMOR	\$17.50

PATENT NOTICE. See Note 4, page x.

TYPE 1000-P4 DUMMY ANTENNA

Connected to the terminated output of a standard-signal generator of 50-ohm output impedance (25 ohms), this dummy antenna provides the output characteristics specified by the Institute of Radio Engineers in 1948 "Standards on Radio Receivers, Methods of Testing Amplitude-Modulation Broadcast Receivers."

Net Weight: 3¼ ounces.

Type	Code Word	Price
1000-P4 Dummy Antenna.....	ARROW	\$15.00

PATENT NOTICE. See Note 4, page x.

TYPE 1000-P10 TEST LOOP

With this shielded test loop, radio receivers with loop antennas can be tested by the preferred method of the 1948 "Standards on Radio Receivers, Methods of Testing Amplitude-Modulation Broadcast Receivers," published by the Institute of Radio Engineers. The 3-turn loop is inclosed in aluminum tubing for electrostatic shield-

ing. Circuit constants are chosen to make the field strength in volts per meter, at a distance of 19 inches from the loop, equal to one-tenth the signal generator output in volts, with a 50-ohm generator.

Dimensions: (Height) 16½ x (width) 11¾ x (depth) 3½ inches.
Net Weight: 4½ pounds.

Type	Code Word	Price
1000-P10 Shielded Test Loop	ARRAY	\$50.00

PATENT NOTICE. See Note 4, page x.

TYPE 1000-P5 V-H-F TRANSFORMER

50 Ohms, Grounded, to 300 Ohms, Balanced

The TYPE 1000-P5 V-H-F Transformer is designed to plug into a standard-signal generator having a 50-ohm unbalanced output and to produce an equal, balanced, open-circuit voltage behind a 300-ohm balanced impedance for r-f measurements of f-m and t-v receivers.

The transformer is mounted in a cylindrical container terminated at one end in a TYPE 874 Coaxial Connector and at the other in a socket designed to receive the Alden TYPE HA902P Connector for standard 300-ohm open parallel-wire line.

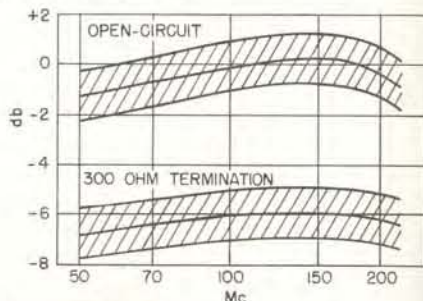

Dimensions: (Length) 4¾ x (diameter) ¾ inches.
Net Weight: 3½ ounces.

Type	Code Word	Price
1000-P5 V-H-F Transformer	ARSON	\$27.50

PATENT NOTICE. See Note 4, page x.

All signal generators and accessories are equipped with TYPE 874 Coaxial Connectors.





TYPE 1000-P6 CRYSTAL DIODE MODULATOR

USES: The crystal diode modulator is an inexpensive absorption modulator for amplitude modulating the output of a radio-frequency generator over the carrier range from 20 to 1000 megacycles. It can be used to modulate the output of standard-signal generators and other oscillators over a modulating-frequency range of 0 to 5 megacycles. It is particularly useful where wide-band modulation, as for television receiver testing is required, or for radio receiver tests where incidental fm must be negligible.

DESCRIPTION: The modulator consists of a crystal diode between input and output terminals, a simple output filter to prevent appreciable modulating voltage appearing in the output, and a means of isolating and applying modulating and bias voltages. Since the resistance of the crystal diode is a function of the voltage across it, this resistance can be modulated by applying a varying voltage. Inserted between a radio-frequency generator and its load, the unit produces amplitude modulation by variation of series impedance.

When the modulator is used with a standard-signal generator, the output attenuator of the generator provides sufficient isolation to prevent reaction of the modulator on the generator frequency. With an oscillator not equipped with an output attenuator, it is recommended that a TYPE 874-G20 (20 db) or a TYPE 874-G10 (10 db) Attenuator be used.



FEATURES:

- When used with a standard-signal generator, the crystal diode modulator works on the output side of the attenuator, so that reaction on the oscillator frequency, and hence frequency modulation, is practically negligible. The power required for modulation is very low.
- For testing television receivers, a video signal, conveniently obtained from a standard receiver tuned to a local station, can be applied to the modulator. The picture modulation can then be put on any channel to which the signal generator is set.

SPECIFICATIONS

Carrier Frequency Range: 20 to 1000 megacycles. The insertion loss increases approximately 10 db at a carrier frequency of 10 megacycles due to output filter.

Modulating Frequency Range: 0 to 5 megacycles. Response is approximately 2 db down at 5 megacycles with a gradual roll-off to prevent serious phase distortion of video signals.

Impedance: The impedance looking into either the input or output terminals is a function of the bias and modulating voltages. This unit was designed for use with a 50-ohm source and a 50-ohm load. The impedance at the modulation terminals is approximately 600 ohms.

Modulation: With no greater than 50 millivolts r-f input, 30% amplitude modulation can be obtained at carrier frequencies between 20 and 1000 Mc. For optimum sine-wave modulation, an average crystal requires 1.5 volts at the bias terminal. The insertion loss under these conditions is approximately 12 db, and approximately 0.2 volt r-m-s at the modulation terminals will produce 30% modulation. Maximum percentage modulation is an inverse function of carrier frequency, and at 1000 megacycles is limited to about 30%. Peak modulation voltage with respect to ground should not exceed 4 volts.

Terminals: The radio-frequency and modulating terminals are provided with TYPE 874 Coaxial Connectors. The modulation terminals will accept either a TYPE 874 Coaxial Connector or a TYPE 274-M Plug. Bias terminals are TYPE 938 Binding Posts.

Crystal Diode: 1N21B.

Accessories Supplied: One TYPE 274-MB Plug.

Other Accessories Required: Terminal adaptors (page 58), unless generator and load are equipped with TYPE 874 Coaxial Connectors; 1.5-volt battery for fixed bias, or a

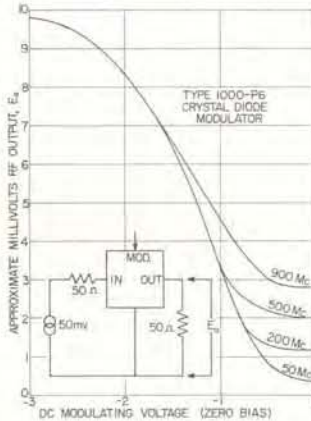

Typical modulation characteristics for the TYPE 1000-P6 Crystal Diode Modulator at various carrier frequencies.

3-volt battery and a 10,000-ohm rheostat for adjustable bias.

Accessories Available:

- TYPE 874-G20 Fixed Attenuator, 20 db
- TYPE 874-G10 Fixed Attenuator, 10 db
- TYPE 874-R20 Patch Cord
- TYPE 1000-P5 V-H-F Transformer
- TYPE 874-Q Coaxial Adaptor

(For description and prices, see pages 41 to 58.)

Dimensions: (Width) 5 x (height) 4 x (depth) 1 1/8 inches, over-all.

Net Weight: 1 pound.

Type	Code Word	Price
1000-P6 Crystal Diode Modulator.....	APPLE	\$40.00

PATENT NOTICE. See Note 4, page x.





TYPE 1000-P7 BALANCED MODULATOR

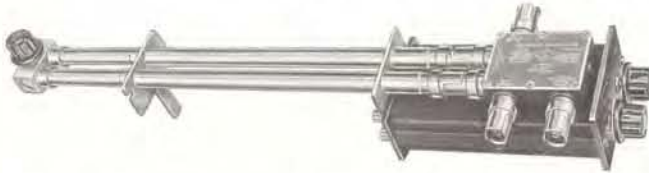

**For 100% Linear AM
and Pulse Modulation**

USES: This instrument is an insertion-loss modulator for pulse and sine-wave modulating the output of radio-frequency-generators over the carrier-frequency range of 60 to 2300 megacycles. It is particularly useful for pulse modulation where a high degree of carrier suppression is desired with good rise-time characteristics, and for linear-modulation systems where full 100% modulation is required over a modulating frequency of 0 to 20 megacycles. Typical applications are tests on:

- television and radar receivers,
- microwave relay systems using multiplex pulse-code modulation,
- omni-range and IME equipment,
- telemetering circuits, and
- narrow-band systems where incidental frequency modulation must be negligible.

The Balanced Modulator is particularly recommended for use with the TYPE 1217-A Unit Pulser or the TYPE 1391-B Pulse, Sweep, and Time-Delay Generator for pulse-modulating the output of TYPE 1021-A Standard-Signal Generator.

DESCRIPTION: Two crystal diodes are used in separate signal paths between the input and the output. In one path a coaxial phasing line, set to an odd multiple of one-half wave-length at the carrier frequency, is inserted. A simple high-pass filter is included in the output circuit.

For small r-f signals the impedances of the diodes can be controlled by varying the applied bias. The diode shunt capacity, which ordinarily limits the frequency range of a diode, is neutralized in the phasing line.

Bias and balance controls are provided for setting the operating points on the diode characteristics. The carrier can be balanced out, or any amount of carrier insertion can be provided by means of these adjustments.

FEATURES:

- High carrier suppression for pulse applications.
- Fast rise time.
- Linear 100% modulation.
- 0-20 Mc modulation frequency range.
- Useful up to 2300 Mc.
- Low incidental frequency modulation.

SPECIFICATIONS

Carrier-Frequency Range: 60 to 2300 megacycles.

Modulation-Frequency Range: Flat from 0 to 20 megacycles. For pulsing, the rise-time contribution is less than 0.02 microseconds.

Impedance: The impedance looking into either input or output terminals is a function of the bias and modulating voltages. The source and load impedances should be 50 ohms. The impedance at the modulation input is 50 ohms $\pm 5\%$. Whenever the attenuation can be tolerated, a TYPE 874-G20 (20 db) or a TYPE 874-G10 (10 db) Fixed Attenuator should be used at the input and another at the output for isolation to minimize frequency modulation and to insure proper load impedance.

Modulation: Double-sideband, suppressed-carrier modulation, pulse modulation with 60-db carrier suppression between pulses, and 100% amplitude modulation can be obtained throughout the carrier frequency range. One volt, peak, at the modulation terminals is sufficient to produce full r-f output from a zero output initial condition.

R-F Output: 10 millivolts, maximum, into 50 ohms on pulses or at modulation peaks, with a source of 50 millivolts behind 50 ohms. At this and lower levels the modulation characteristics are independent of input voltage. Higher input voltages and, consequently, higher output voltages are permissible if bias and balance readjustments are made for each change in level. The r-f source must not exceed 0.5 volt behind 50 ohms, or the crystal diodes may be damaged.

Bias Supply: Self-contained battery of flashlight cells.

Terminals: TYPE 874 Coaxial Connectors. The radio-frequency input terminal is of proper elevation to plug directly into the output connector of the TYPE 1021-A

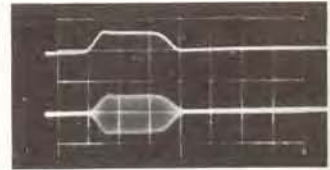
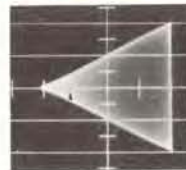

(Left) Amplitude modulation characteristic at 900 megacycles. Peak r-f output is 10 millivolts; r-f input, 50 millivolts. (Right) Oscilloscope showing modulation pulse and r-f output pulse. Pulse duration is 0.25 μ sec with 0.05 μ sec rise time. Carrier frequency is 60 megacycles. Scale is 0.1 μ sec per horizontal division.

Signal Generator. Adaptors to other types of connectors are described on page 58.

Crystal Diodes: Two TYPE 1N21-B.

Accessories Supplied: One TYPE 1000-P7-28 40-cm Cable; one TYPE 1000-P7-28-2 80-cm Cable; one TYPE 874-C58 Cable Connector.

Other Accessories Required: Suitable coaxial cable for connecting modulation source. TYPE 874-R33 (page 56) is recommended.

Accessories Available: TYPE 874-G Fixed Attenuators (page 54); TYPE 1000-P5 VHF transformer; TYPE 874-R Patch Cords (page 56).

Dimensions: (Including fully extended adjustable line) 30 inches (width) x 3 inches (height) x 5 inches (depth) over-all. Length with line telescoped — 20 inches.

Net Weight: 6 pounds.

Type	Code Word	Price
1000-P7 Balanced Modulator.....	AWAKE	\$200.00

PATENT NOTICE. See Note 4, page 8.



OSCILLATORS



A source of power or test voltage is a prerequisite to nearly all types of measurements. Since 1919 the General Radio Company has been supplying laboratory oscillators for this purpose and has always pioneered in new designs and circuits.

Functionally, these oscillators can be grouped under the following classifications:

(1) LC and Resonant-Cavity Types—the frequency is determined by inductive and capacitive elements or by resonant cavities.

(2) Beat-frequency types—the output frequency is the difference between the frequencies of two oscillators, one variable and one fixed. This type covers a wide frequency range with a single control.

(3) RC degenerative types—the frequency is determined by resistive and capacitive elements, and the circuit is highly degenerated except at the pass frequency. This type of oscillator also covers a wide frequency range with a single control and, alternatively, can be designed to produce a number of fixed frequencies, as selected by a switch.

(4) Electro-mechanical types—the frequency is determined by a vibrating element.

The General Radio Company manufactures all of the functional types listed above, and the characteristics of available models are tabulated on the next page.

LC and Resonant-Cavity Types: Although most useful at radio frequencies, the LC oscillator, because of its stability, good waveform, and efficiency finds particular uses where fixed audio frequencies are needed.

General Radio makes several audio-frequency oscillators of this type. Of particular interest is the TYPE 1307-A Transistor Oscillator, a miniature instrument designed primarily for calibrating sound measuring equipment. The TYPE 1214 Unit Oscillators, conventional vacuum-tube types, generate fixed frequencies and are useful for modulating high-frequency oscillators and as bridge power sources.

At radio frequencies where tuning can be accomplished by air capacitors, the L-C circuit is the best and most economical frequency-determining system. The TYPE 1330-A Bridge Oscillator uses tuned circuits to cover a frequency range of 10,000: 1. The TYPES 1211-B, 1208-B, 1215-B and 1209-B and 1209-BL Unit Oscillators cover a wide range of frequencies up through the uhf television

bands. The latter two use the butterfly circuit, which is a General Radio development.

At frequencies above 1000 Mc, resonant cavities are readily adapted to frequency control. The TYPE 1218-A Unit Oscillator covers a continuously tuned frequency range from 900 Mc to 2000 Mc with ganged quarter-wave lines, and the TYPE 1220-A Unit Klystron Oscillator can be adjusted to produce spot frequencies between 2700 Mc and 7500 Mc.

The radio-frequency oscillators can all be amplitude modulated with sine waves, and the TYPE 1218-A and TYPE 1220-A can be square-wave-and pulse-modulated as well. The TYPE 1220-A also has provision for frequency modulation up to deviations of ± 7.5 Mc, and the Unit Oscillators, in particular, are adapted for mechanical sweeping (see page 199).

Beat-Frequency Types: The first commercial beat-frequency oscillator was produced by General Radio in the middle 1920's. As the development of tubes and circuits has progressed, increasingly better models have been developed, culminating in the present TYPE 1304-B, whose logarithmic scale greatly facilitates frequency-response measurements. This oscillator can be used with the dial drives described on page 151.

RC Types: The RC degenerative type is an original General Radio development. Two models are offered, the TYPE 1301-A, whose primary characteristic is low distortion, and the TYPE 1302-A, designed for a wide frequency range. Two other RC oscillators use a phase-shift circuit: the TYPE 1210-C and the TYPE 1305-A.

The TYPE 1210-C Unit R-C Oscillator is a small, versatile instrument, which produces either sine-wave or square-wave output over a wide frequency range, and which becomes an inexpensive sweep oscillator when combined with the TYPE 908-P2 Synchronous Dial Drive, as described on page 151.

The TYPE 1305-A Low-Frequency Oscillator generates frequencies as low as 0.01 cycle per second, with three-phase and four-phase output as well as an output continuously variable in phase over 360° .

Electro-Mechanical Types: An audio-frequency tuning fork, the TYPE 723, is a useful source for continuous operation, as in modulating beacon transmitters and as a reference for frequency and time measurements.





Type	Name	Class	Frequency Range	Maximum Output	Open-Circuit Volts	Nominal Load Impedance	Harmonic Distortion	Power Supply	See Page No.	
Audio and Low Frequency	1304-B	Beat-Frequency Audio Generator	20-20,000 c 20,000-40,000 c	1 w	50	600 ohms, balanced or grounded	< 1%	AC Line	104	
	1301-A	Low-Distortion Oscillator	20-15,000 c (27 fixed frequencies)	18 mw 100 mw	6.6 30	600 ohms, balanced or grounded 5000 ohms, grounded	< 0.1%	AC Line	101	
	1302-A	Oscillator	10-100,000 c	40 mw 20 mw 80 mw	10 5 20	600 ohms, balanced 300 ohms, grounded 5000 ohms, grounded	< 1%	AC Line	106	
	1305-A	Low-Frequency Oscillator	RC	170 mw per phase	10	600 ohms	< 1%	AC Line	102	
	1214-D	Unit Oscillator	Tuned Circuit	200 mw	60	Matched	< 3%	AC Line	112	
	1214-E	Unit Oscillator	Tuned Circuit	300 mw	28	800 ohms	< 3%	AC Line	112	
	1307-A	Transistor Oscillator	Tuned Circuit	6 mw	2	600 ohms	< 5%	Mercury Cells	107	
	723	Vacuum-Tube Fork	Electromechanical	400 or 1000 c (2 Models)	50 mw	31	50, 500, 5000 ohms	< 0.5%	AC Line	107
	1214-A	Unit Oscillator	Tuned Circuit	400 and 1000 c	200 mw	80	8000 ohms grounded or ungrounded	< 3%	AC Line	112
	1210-C	Unit RC Oscillator	RC	20 c-0.5 Mc	80 mw 40 mw 90 mw	7 45 30	50 to 1250 ohms, 14,000 ohms, 2,500 ohms,	< 1.5% < 5% Square Wave	Unit Power Supply	110
Medium and High Frequency	1214-M	Unit Oscillator	1 Mc	300 mw	7	50 ohms	< 3.5%	AC Line	112	
	1330-A	Bridge Oscillator	60, 400, 1000 c 5 kc-50 Mc	0.75 w 1 w	12 10	50 ohms 20-80 ohms	< 3%	AC Line	108	
	1211-B	Unit Oscillator	0.5-5 Mc 5-50 Mc	2 w 200 mw		50 ohms		Unit Power Supply	114	
VHF and UHF	1208-B	Unit Oscillator	65-500 Mc	100 mw		50 ohms		Unit Power Supply	114	
	1209-BL	Unit Oscillator	180-600 Mc	300 mw		50 ohms		Unit Power Supply	115	
	1209-B	Unit Oscillator	250-920 Mc	200 mw		50 ohms		Unit Power Supply	114	
	1215-B	Unit Oscillator	50-250 Mc	80 mw		50 ohms		Unit Power Supply	114	
	1218-A	Unit Oscillator	900-2000 Mc	200 mw		50 ohms		Unit Power Supply	114	
	1220-A	Klystron Oscillator	2700-3275 Mc 3400-4910 Mc 5100-5900 Mc 5925-7425 Mc	40 mw		50 ohms		Unit Power Supply	116	





TYPE 1301-A LOW-DISTORTION OSCILLATOR



This oscillator has an exceptionally pure waveform, which makes it an ideal source of test voltage for distortion measurements or a power source for audio bridge measurements.

Frequencies are selected instantly by push-button controls and include those recommended by the Federal Communications Commission for distortion measurements of broadcast transmitters. Thus, in combination with the TYPE 1932-A Distortion and Noise Meter, (page 225), it provides a fast and accurate means for making these transmitter tests.

When this oscillator is used as a bridge power source, null balance is found more precisely and easily because of the low level of harmonic voltage present at the null point.

The oscillator uses the inverse-feedback RC circuit invented and developed by the General Radio Company. Separate feedback networks

control the frequency and amplitude, thus providing high stability and low distortion.

Mica capacitors and wire-wound resistors, chosen for maximum stability, are used in the frequency-determining network. Amplitude control is automatic, normally requiring no adjustment as various frequencies are selected.

FEATURES:

- Very low distortion, less than 0.1% over most of range.
- Excellent frequency stability.
- Constant output voltage.
- Instant selection of any one of 27 test frequencies by push-button control.
- Lower frequency range of 2 to 15 cycles available from convenient plug-in range-extension unit.
- Any other frequency between 2 and 15,000 cycles may be obtained by plug-in resistors.

SPECIFICATIONS

Frequency Range: 27 fixed frequencies between 20 and 15,000 cycles. (Also 2 to 15 cycles by use of extension unit.)

Accuracy: $\pm(1\frac{1}{2}\% + 0.1 \text{ cycle})$.

Frequency Control: One push-button switch provides a frequency, and a second multiplies this frequency by 1, 10, or 100.

Frequency Stability: Changes in ac line voltage or output load have no effect upon the frequency. Drift is not greater than 0.02% per hour after the first 10 minutes.

Output Impedance: A push-button switch selects one of three output impedances: 600 ohms balanced to ground, 600-ohms unbalanced, or 5000 ohms unbalanced.

The actual output impedance of the 5000-ohm circuit will vary between 1000 and 6000 ohms, depending on the setting of the volume control potentiometer, which also has slight effect on the 600-ohm output circuit. The 600-ohm balanced output circuit is balanced to all audio frequencies when operated into a balanced load of any impedance.

Output Power: 18 milliwatts into 600-ohms, or 6.6 volts open circuit; 100 milliwatts into 5000-ohms, or 30 volts open circuit. Output voltage is constant with frequency within $\pm 1 \text{ db}$.

Waveform Distortion: 5000-ohm output, not more than 0.1%; 600-ohm output, not more than 0.1% between

50 and 7500 cycles, and not more than 0.25% below 50 cycles. Range-extension unit add less than 1%.

Power Supply: 105 to 125 (or 210 to 250) volts, 25 to 60 cycles, 45 watts. Specify line voltage and frequency when ordering.

Power input receptacle accepts either 2-wire (TYPE CAP-35) or 3-wire (TYPE CAP-15) power cord. Two-wire cord is supplied. For 3-wire, see page 237.

Operation from 400-cycle supply is possible if line voltage is between 110 and 125 volts; power-frequency hum is increased at 200- and 400-cycle output.

Tube Complement: One each, 6X5-GT/G, 6W6-GT, 6SL7-GT, 6D3/VR-150, 6Y6-G, 6SK7, 6SQ7-GT, 6SJ7.

Terminals: Jack-top binding posts with standard $\frac{3}{4}$ -inch spacing, a ground terminal and a standard Western Electric double output jack on the front panel; Duplicate output terminals on the rear of the instrument.

Accessories Supplied: CAP-35 Power Cord, multipoint connector, TYPE 1301-201 plug assembly, spare fuses.

Mounting: Relay-rack panel. End frames are available for table mounting. (See price table below.)

Panel Finishes: Standard General Radio crackle. Certain other standard finishes to match transmitters can be supplied at small extra cost.

Dimensions: Panel (length) 19 x (height) 7 inches; depth behind panel, 12 inches. **Net Weight:** 31 $\frac{1}{2}$ pounds.

Type		Code Word	Price
1301-A	Low Distortion Oscillator	OZONE	\$595.00
1301-P1	Range Extension Unit (2 to cps)	OVATE	80.00
FRI-412	Aluminum End Frames	ENDFRAMDIG	13.00 Pair





TYPE 1305-A LOW-FREQUENCY OSCILLATOR

USES: This oscillator is primarily a source of very low frequency sinusoidal signals and has many uses in the development and test of servo-mechanisms, low-frequency amplifiers, recorders, geophysical equipment, medical instruments, and electrical analogs of mechanical systems.

It can be used to measure the gain and phase-shift of 4-terminal devices and to determine the complex transfer characteristics of amplifiers and servo-mechanisms.

Its usefulness in a variety of applications is greatly enhanced by its three-phase output (0° , 120° , 240°).

It includes a phase shifter whose output is continuously variable in phase from 0° to 360° with one complete turn of a dial. Phase measurements at these low frequencies are thereby made possible by Lissajous pattern techniques.

An adaptor provides a four-phase output (0° , 90° , 180° , and 270°) which is useful for applications requiring quadrature signals, such as component resolution and circular oscilloscope sweeps.

With suitable amplifiers, this oscillator can operate as a variable-frequency drive for the study of the performance of 2-phase or 3-phase machines, such as low-power motors and synchros.

DESCRIPTION: The TYPE 1305-A Low-Frequency, Three-Phase Oscillator uses three in-

¹Smiley, G., "Ultra-Low Frequency, Three-Phase Oscillator", *Proc. IRE*, 42, pp. 677-680 (April, 1954).

dependent RC phase-shift networks in a phase-shift oscillator circuit.¹ In order to achieve very-low-frequency operation with components of practical size, the "Miller Effect"² is used to increase the effective size of the capacitors. The RC phase-shift networks are connected as low-pass filters, and the entire oscillator is direct-coupled for circuit stability. A network of biased diodes serves as an amplitude regulator which provides an extremely high degree of amplitude stabilization independent of frequency. Cathode-follower circuits provide low-distortion, low-impedance outputs. A six-phase rectifier and meter connected across the output provide a direct indication of output voltage with only slight ripple even at the lowest frequencies. An output attenuator permits 60-db reduction in output level, for convenience in studies of high-gain systems.

The phase shifter is composed of a potentiometer and a purely resistive network which, when provided with a three-phase input, produces an output that is constant in amplitude and continuously variable in phase independent of frequency.

The Four-Phase Output Adaptor is a plug-in unit, which contains a purely resistive network to convert the three-phase to a four-phase output, again completely independent of frequency.

²Miller, J. M., Bureau of Standards Scientific Paper No. 351, June 11, 1919.





FEATURES:

- Low-frequency output, 0.01 to 1000 cycles.
- Three-phase output (0°, 120°, and 240°) provided, and four-phase (0°, 90°, 180°, and 270°) output available with adaptor.
- Additional output signal with continuously variable phase for convenient phase measurements.
- Meter measures output voltage directly, with low ripple even at lowest frequencies.

- Excellent amplitude stability and low distortion.
- Polystyrene-dielectric capacitors are used on low-frequency ranges for error-free operation.
- Logarithmic frequency scale.
- Regulated power supply eliminates effect of line-voltage variations.
- Output step attenuator allows convenient reduction of output level in three 20-db steps.

SPECIFICATIONS

Frequency Range: 0.01 to 1000 cycles in five ranges.
Frequency Control: The main frequency control dial is engraved from 1 to 10 cycles. A range switch multiplies the scale frequencies by 0.01, 0.1, 1, 10, and 100.
Frequency Calibration Accuracy: $\pm 3\%$.
Frequency Stability: Warm-up drift is less than 1% in the first ten minutes, less than 0.2% in the next hour.
Three-Phase Output: At least 10 volts rms, open circuit, line-to-neutral, behind 600 ohms in each phase, constant with frequency to $\pm 5\%$. Phase voltages are equal to each other within $\pm 2\%$.

The DIRECT position of the output attenuator switch provides 75 ohms per phase but must not be loaded with less than 600 ohms per phase, wye-connected, or 1800 ohms per phase, delta-connected. A neutral terminal is provided. Phase Accuracy, $\pm 2^\circ$.

Output power is 167 milliwatts per phase, maximum, into a 3-phase wye-connected load of 600 ohms per phase.

Four-Phase Output: At least 5 volts, rms, line-to-neutral, behind 600 ohms, from the 4-phase adaptor. Phase Accuracy, $\pm 3^\circ$.

Variable-Phase Output: At least one volt, rms, behind the impedance of the output potentiometer (50,000 ohms, maximum). Phase accuracy, $\pm 3^\circ$.

Waveform: Total harmonic content is less than 3% for all output values and for all frequencies for any load except in the DIRECT position of OUTPUT ATTENUATOR switch. For the DIRECT position of the OUTPUT ATTENUATOR switch, total harmonic content is less than 3% for any wye-connected load of more than 600Ω

per leg or delta-connected load of more than 1800Ω per phase. Line-frequency hum in the output is less than 10 millivolts.

Terminals: TYPE 938 Binding Posts. Neutral can be connected to the chassis, which can be grounded through a 3-wire power cord.

Mounting: Aluminum, 19-inch, relay-rack panel; aluminum cabinet. For table mounting (TYPE 1305-AM), aluminum end frames are supplied to fit ends of cabinet; for relay-rack mounting (TYPE 1305-AR), brackets for holding cabinet in rack are supplied. Relay-rack mounting is so arranged that panel and chassis can be removed from cabinet, leaving cabinet in rack, or cabinet can be removed from rear of rack, leaving panel attached to rack.

Power Supply: 105 to 125 (or 210 to 250) volts, 50 to 60 cycles. Total power consumption is 135 watts. Instrument will operate satisfactorily on power-supply frequencies up to 400 cycles.

Power input receptacle will accept either 2-wire (TYPE CAP-35) or 3-wire (TYPE CAP-15) power cord. Two-wire cord is supplied. For 3-wire, see page 237.

Tube Complement: Four each 6197; three each 6BH6, 5963; one each OB2, 12AX7, 6080; six 1N536 crystal diodes; eight 1N119 crystal diodes; one SV18 crystal diode.

Accessories Supplied: TYPE CAP-35 Power Cord, three TYPE 274-MB Double Plugs, spare fuses, Four-Phase Output Adaptor TYPE 1305-P1.

Dimensions: Panel, (width) 19 x (height) 7 inches; depth behind panel, 12 inches. **Net Weight:** 35 pounds.

Type		Code Word	Price
1305-AM	Low-Frequency Oscillator, Bench Model.....	DEBUT	\$940.00
1305-AR	Low-Frequency Oscillator, Relay-Rack Model.....	DONOR	940.00

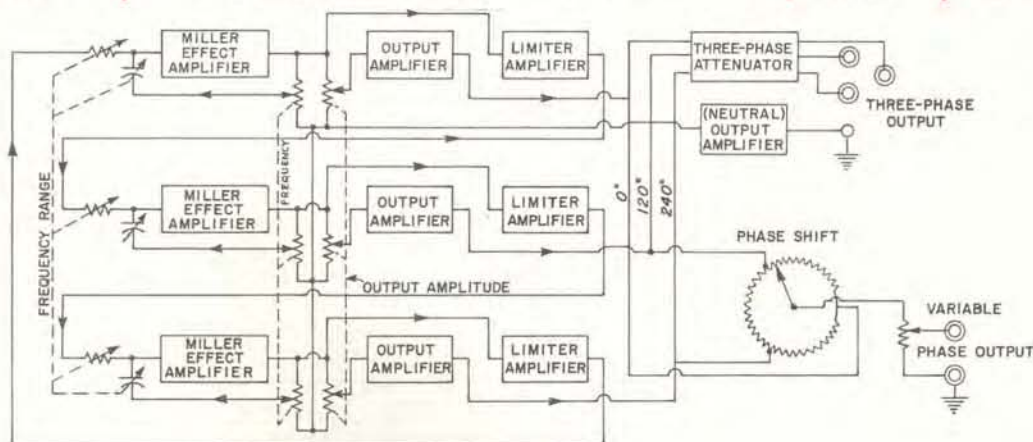



TYPE 1304-B BEAT-FREQUENCY AUDIO GENERATOR

USES: For amplitude-frequency tests on audio frequency equipment—lines, amplifiers, filters, equalizers, transducers, and other networks—this beat-frequency generator is the best test-signal source that can be used. Its especial fitness for these applications lies in four of its characteristics:

- (1) its frequency scale is logarithmic;
- (2) it covers the entire audio range in one sweep of the dial;
- (3) its output voltage is constant with frequency.
- (4) its distortion is extremely low.

The TYPE 1521-A Graphic Level Recorder (page 147) is designed to drive the oscillator dial through a chain-and-gear system. For use with an X-Y plotter, the TYPE 908-R Dial Drives (page 152) are recommended. These, as well as the TYPE 908-P Dial Drives, (page 151) attach directly to the oscillator dial in place of the knob.

As a general-purpose audio generator, the TYPE 1304-B finds constant use in the electronics laboratory, as a power source for bridge measurements, as a modulator for rf signal generators, and as a test source for acoustic work at both audio and ultrasonic frequencies.

DESCRIPTION: This generator has a number of unusual design features that contribute to superior performance and ease of operation. Two radio-frequency oscillators, one fixed and one variable, feed a pentagrid converter through buffer amplifiers. The resulting difference frequency, after passing through a low-pass filter, is amplified in a degenerative amplifier. The output stage of this amplifier is

the unique, low-distortion, single-ended, push-pull circuit.*

The oscillator output level is continuously adjustable, and the output can be connected for either balanced or unbalanced use. The unbalanced output circuit contains a three-step attenuator. The output voltmeter is calibrated in dbm and open-circuit output volts.

The output voltmeter is used to standardize the frequency calibration of the oscillator when the output frequency is set to either the power-line frequency or to zero beat.

The frequency dial carries a logarithmic frequency scale for the range 20 c to 20 kc, and it is driven by a slow-motion gear-reduction drive, essentially free from backlash. A cycles-increment dial provides a means of varying the frequency over a range of ± 50 cycles at any setting of the main dial.

A second range from 20 kc to 40 kc is available by the operation of a single panel switch.

FEATURES:

- Essentially constant output voltage.
- Output voltmeter for accurate and rapid setting, and accurate attenuator.
- Frequency coverage from 20 c to 40 kc.
- Audio spectrum—20 c to 20 kc covered in a single sweep of the dial.
- High stability of both output and frequency.
- Very low hum level.
- Excellent waveform.
- Dial can be motor driven.
- High quality components, stabilized power supply, and advanced circuit design.

*A. P. G. Peterson and D. B. Sinclair, "A Single-Ended Push-Pull Audio Amplifier," Proc. I.R.E., vol. 40, pp. 7-11, January, 1952.





SPECIFICATIONS

Frequency Range: 20 to 40,000 cycles in two ranges.

Frequency Controls: The main control is engraved from 20 to 20,000 cycles per second and has a true logarithmic frequency scale. The total scale length is approximately 12 inches. The effective angle of rotation is 240°, or 80° per decade of frequency. For the higher range, throwing a panel switch adds 20 kc to the scale frequency. The frequency increment dial is calibrated from +50 to -50 cycles.

Frequency Calibration: Within $\pm (1\% + 0.5 \text{ cycle})$ after the oscillator has been correctly set to the line frequency or to zero beat. The 20 kc added by the range switch is accurate within $\pm 0.5\%$. Accuracy of frequency-increment dial is $\pm 1 \text{ cycle}$.

Zero-Beat Indicator: The output voltmeter is used to indicate zero beat.

Frequency Stability: The drift from a cold start is less than 7 cycles in the first hour and is essentially completed within two hours.

Output Voltmeter: Calibrated in volts output at open circuit, and in dbm. Above 10% of full scale the calibration is accurate within $\pm 5\%$ of the reading.

Output Attenuator: Used only with single-ended output; has three steps of 20 db each, with an accuracy of $\pm 1\%$ of the nominal attenuation.

Output Control: For each step of the attenuator the output voltage can be varied continuously from zero to the maximum voltage.

Output Voltage: Continuously variable from below 5 millivolts to 50 volts, open circuit. Full-scale, open circuit output voltages of 50 millivolts, 5 volts, and 50 volts are provided.

Frequency Characteristic: For a 600-ohm resistive load the variation of output voltage with frequency is as follows:
 NORMAL Range, 20 to 20,000 c $\pm 0.25 \text{ db}$
 ADD 20 KC Range, 20-30 kc, $\pm 0.5 \text{ db}$
 30-40 kc, $\pm 1.0 \text{ db}$

For open-circuit operation the output voltage rises considerably at the higher frequencies.

Output Impedance: 600 ohms, resistive, within $\pm 2\%$. At + 20 dbm setting of the output attenuator, the

output may be used either balanced or with one side grounded. With one side of the output grounded, the attenuator may be used throughout its entire range.

Output Power: 1 watt, max., into a 600-ohm resistive load.

Harmonic Distortion: Less than 0.25% from 100 to 10,000 cycles. Below 100 cycles the harmonic content increases and may reach 0.5% at 50 cycles. Above 10,000 cycles the harmonic content is less than 1%.

AC Hum: Less than 0.1% of the output voltage for output voltmeter readings above 10% of full scale.

Terminals: TYPE 938 Binding Posts and standard Western Electric double output jack on panel; a standard four-terminal socket at the rear.

Mounting: Aluminum, 19-inch, relay-rack panel; aluminum cabinet. For table mounting (TYPE 1304-BM), aluminum end frames are supplied to fit ends of cabinet; for relay-rack mounting (TYPE 1304-BR), brackets for holding cabinet in rack are supplied. Relay-rack mounting is so arranged that panel and chassis can be removed from cabinet, leaving cabinet in rack, or cabinet can be removed from rear of rack, leaving panel attached to rack.

Power Supply: 105 to 125 (or 210 to 250) volts, 50 to 60 cycles. Power consumption is about 100 watts. Power input receptacle will accept either 2-wire (TYPE CAP-35) or 3-wire (TYPE CAP-15) power cord. Two-wire cord is supplied. For 3-wire, see page 237.

Tube Complement:
 2 — 6SL7-GT 1 — 6SA7
 2 — 6AV5-GA 1 — 12AT7
 2 — 0D3 1 — 5V4-G

Accessories Supplied: TYPE CAP-35 Power Cord, four-terminal plug, and spare fuses.

Dimensions: 19 3/8 x 15 1/4 x 7 1/4 inches over-all.
Net Weight: 39 pounds.



TYPE 1304-B Generator driven by a TYPE 908-R Dial Drive for use with an X-Y plotter.



TYPE 1304-B Generator driven by TYPE 1521-A Graphic Level Recorder.

Type		Code Word	Price
1304-BM	Beat-Frequency Audio Generator, Bench Model	CAROL	\$625.00
1304-BR	Beat-Frequency Audio Generator, Relay Rack Model...	CARGO	625.00

PATENT NOTICE. See Notes 2, 5, 9, and 15, page x.

Another Beat-Frequency Oscillator, the TYPE 1107-A, (page 81) has a linear scale from 0 to 5000 cycles and is used as an interpolating device in frequency measurements.





**TYPE 1302-A
OSCILLATOR**

USES: The wide range and the excellent frequency and amplitude stabilities of this oscillator make it a superior source of power for bridges and other measurement networks. It is particularly recommended for use with the TYPE 716-C Capacitance Bridge and is used in the TYPE 1610-A Capacitance Measuring Assembly (page 14).

DESCRIPTION: This instrument is an RC oscillator employing an inverse-feedback circuit. The frequency-determining network is a Wien bridge, in which the capacitive elements are controlled by the main frequency dial, and resistive elements are selected by a range switch.

The amplitude of oscillation is held constant by using a second bridge section, one arm of

which is a non-linear resistance. A buffer amplifier ahead of the output control minimizes reaction on the oscillator frequency.

Both balanced and grounded outputs are provided.

FEATURES:

- Wide frequency range, 10 to 100,000 cycles.
- Excellent frequency stability.
- Low harmonic distortion.
- Semi-logarithmic scale eliminates crowding at the low-frequency end and still allows precision setting of high frequencies.
- Voltage regulation in the power supply removes effects of line-voltage transients and allows the instrument to operate over a wide range of supply voltages.

SPECIFICATIONS

Frequency Range: 10 to 100,000 cycles in four ranges.
Frequency Control: The main control dial is engraved from 10 to 100 cycles. Four multiplier switches multiply the scale frequencies by 1, 10, 100, or 1000.
Frequency Calibration: $\pm (1\frac{1}{2}\% + 0.2 \text{ cycle})$.
Frequency Stability: Warm-up drift is less than 1% in the first ten minutes, less than 0.2% during the next hour.
Output Impedance: Balanced 600 ohms and grounded 5000 ohms. The internal impedance of the 600-ohm output is constant at 550 ohms; if the LOW output terminal is grounded it becomes 300 ohms, grounded. In the 5000-ohm output impedance position, (for 5000-ohm loads) the internal impedance of the oscillator averages approximately 400 ohms.
Output Voltage: At least 20 volts open circuit on 5000-ohm output, and 10 volts open circuit on 600-ohm output, $\pm 1.0 \text{ db}$ over the entire frequency range.
Output Power: 80 milliwatts, maximum, into a 5000-ohm load; 40 milliwatts, maximum into a balanced 600-ohm load; 20 milliwatts into a 300-ohm load.
Waveform: Total harmonic content is less than 1% for all output values and at all frequencies, for 5000-ohm output; less than 0.5% for 600-ohm output. Considerable deviations from nominal load impedances do not appreciably affect the distortion.

A-C Hum: 5000-ohm output, 24 millivolts, maximum. 600-ohm output, 12 millivolts, maximum.
Terminals: Jack-top TYPE 938 Binding Posts with standard $\frac{3}{4}$ -inch spacing. The separate ground terminal has a strap which can be used to ground the LOW output terminal. Output is also available at a multipoint connector at the rear of the instrument. A mating connector is supplied.
Mounting: Relay-rack panel easily adapted for table mounting by the addition of end frames. (See below).
Power Supply: 105 to 125 (or 210 to 250) volts, 50 to 60 cycles. Total power consumption is 90 watts.
 Instrument will operate satisfactorily on power-supply frequencies up to 400 cycles.
 Power input receptacle will accept either 2-wire (TYPE CAP-35) or 3-wire (TYPE CAP-15) power cord. Two-wire cord is supplied. For 3-wire, see page 237.
Tube Complement: Two each: 6SL7-GT, 6W6-GT. One each: 6AK6, 6F6, 6V6-GT, 6J5-GT, 5V4-G, OD3.
Accessories Supplied: TYPE CAP-35 Power Cord, TYPE 274-NK Shielded Plug, spare fuses, and multipoint-connector.
Dimensions: Panel (width) 19 × (height) 7 inches; depth behind panel, 12 inches.
Net Weight: 30 pounds.

Type		Code Word	Price
1302-A	Oscillator.....	FINAL	\$450.00
FRI-412	Aluminum End Frames	ENDFRAMDIG	13.00 Pair

PATENT NOTICE: See Note 2, page 8.





TYPE 1307-A TRANSISTOR OSCILLATOR

In addition to its primary use as a power source for the TYPE 1552-B Sound-Level Calibrator, this pocket-size oscillator is most convenient for use in continuity checks of audio systems, in setting operating levels, in checking sensitivity of oscillographs, in making preliminary calibrations of electronic systems, and as a power source for bridge measurements at 400 and 1000 cycles.

DESCRIPTION: The oscillator uses a P-N-P junction transistor in a Hartley circuit. The inductor in the tuned circuit includes a winding for coupling to the load, and a rectifier-type voltmeter is connected across this winding to indicate output voltage.



SPECIFICATIONS

Frequency: 400 and 1000 cycles.
Frequency Accuracy: $\pm 3\%$ at 2 volts output into 600-ohm resistive load.
Output: Adjustable to a maximum of at least 2 volts into a 600-ohm load.
Distortion: Less than 5% at 400 c with 2 volts across a resistive 600-ohm load.
Voltmeter: Calibrated in volts, with 3 volts full scale.
Output Circuit: Output cable (20 inches) terminated in a TYPE 274-MB Double Plug.

Batteries: Three mercury A batteries (Mallory RM-1 or equivalent) are supplied.
Transistor: One P-N-P junction transistor (RCA TYPE 2N105 or equivalent).
Case: Aluminum, crackle finish.
Carrying Case: Leather case with a strap is available for holding both oscillator and sound-level calibrator.
Dimensions: Case, $6 \times 3\frac{1}{8} \times 2\frac{1}{2}$ inches, over-all.
Net Weight: 1 pound, 14 ounces, with batteries.

Type		Code Word	Price
1307-A	Transistor Oscillator	OMEGA	\$85.00
1560-P31	Leather Carrying Case (for both oscillator and calibrator)	CANOE	10.00

TYPE 723 VACUUM-TUBE FORKS

The TYPE 723 Vacuum-Tube Forks are compact, highly stable, fixed-frequency electro-mechanical oscillators with excellent waveform. They are used for distortion measurements, modulators, power sources for impedance bridges and transmission-line measurements, and as sources of timing pulses for oscillograms. An a-c power supply is included that may be replaced with batteries, if desired.



SPECIFICATIONS

Frequency: 400 or 1000 cycles.
Frequency Stability: Total warm-up frequency drift 0.15 to 0.2%, most of which occurs in first half-hour of operation. Temperature coefficient of frequency -0.008% per degree Fahrenheit. Voltage coefficient of frequency is negligible. Frequency is independent of load.
Accuracy: $\pm 0.05\%$ at ambient temperature 25° C.
Output: 45 milliwatts into a matched load.
Output Impedance: 50, 500, or 5000 ohms.
Waveform and Hum Level: Total harmonic content is less than 0.5%. Power-supply hum is less than 0.1%.
Power Supply: 105 to 125-volt, 40 to 60-cycle line. Bat-

teries can be substituted for the power pack for field use. For battery operation, one Burgess 4FH (1½-volt) and two Burgess Z30NX (45-volt), or equivalent, are required. The ON-OFF switch is arranged to control either ac line or battery current.
Tube Complement: 1-1A5, 1-0C3.
Accessories Supplied: TYPE CAP-35 Power Cord.
Mounting: Phenolic panel; walnut-finish hardwood cabinet.
Over-all Dimensions: (Length) $10\frac{5}{8} \times$ (width) $6\frac{1}{4} \times$ (height) $7\frac{3}{4}$ inches.
Net Weight: 9¼ pounds.

Type		Code Word	Price
723-C	Vacuum Tube Fork (1000 cycles)	SOLID	\$185.00
723-D	Vacuum Tube Fork (400 cycles)	SULKY	200.00





TYPE 1330-A BRIDGE OSCILLATOR

USES: The Bridge Oscillator is a stable, variable-frequency source of power for bridge and other measurements at audio and radio frequencies. It supplies three fixed audio frequencies and a wide range of radio frequencies, continuously adjustable, with power output sufficiently high for most laboratory measurements. It covers the frequency range of the TYPE 1606-A and TYPE 916-AL Radio Frequency Bridges and the TYPE 716-CS1 Capacitance Bridge. At audio frequencies it can be used with the TYPE 716-C Capacitance Bridge, the TYPE 1603-A Z-Y Bridge, the TYPE 1652-A Inductance Bridge, and the TYPE 1661-A Vacuum-Tube Bridge. Its power output of about one watt is adequate for most resonant-circuit measurements. The TYPE 1330-A Bridge Oscillator is an economical, general-purpose, laboratory source, of maximum utility and adaptability.

DESCRIPTION: Both the circuit and the mechanical construction of the Bridge Oscillator are similar to those used in the TYPE 1001-A Standard-Signal Generator (page 92), but a

higher-power oscillator tube is used, and the aperiodic output stage has been omitted. Tuning capacitor and inductors are ruggedly constructed to assure frequency stability, the oscillator circuits are doubly shielded to minimize stray fields, and a modulating circuit of unusual design provides excellent modulation characteristics over the radio-frequency range.

Modulation is available at two audio frequencies and at two levels, selected by switches.

Output terminals are TYPE 874 Coaxial Connectors, and coaxial cables and adaptors are supplied to permit complete shielding from the oscillator to the measuring circuit.

FEATURES:

- Wide frequency range.
- Internal modulation available.
- Good frequency stability with low distortion.
- Excellent shielding.
- One watt output over much of the radio frequency range.
- Rugged and compact construction.

SPECIFICATIONS

Frequency Range: Three fixed audio frequencies (power-line frequency, 400 c, and 1000 c) and a continuous frequency spectrum from 5 kc to 50 Mc in eight direct-reading ranges as follows: 5 to 15 kc, 15 to 50 kc, 50 to 150 kc, 150 to 500 kc, 0.5 to 1.5 Mc, 1.5 to 5 Mc, 5 to 15 Mc, and 15 to 50 Mc.

Frequency Accuracy: $\pm 5\%$ for the 400- and 1000-cycle fixed frequencies, $\pm 2\%$ for the carrier frequencies above 150 kilocycles, and $\pm 3\%$ for the carrier frequencies below 150 kilocycles under no-load conditions. A 50-ohm resistive load may cause a frequency shift of as much as $\pm 5\%$ at some of the lower carrier frequencies; above 150 kilocycles, the frequency shift due to a 50-ohm load

is usually less than $+1\%$. From 5 kilocycles to 15 Mc, the dial calibration is logarithmic.

Incremental-Frequency Dial: The slow-motion dial indicates frequency increments of 0.1% per division from 5 kc to 15 Mc.

Output Voltage and Power: The AUDIO output jack provides a fixed voltage output of approximately 12 volts open circuit, or a power output of approximately $\frac{3}{4}$ watt into a matching 50-ohm load; the output at the RF jack is controlled by the RF control and supplies adjustable output for the 5 kc to 50 Mc range; over the mid-frequency range, the open circuit output voltage is approximately ten volts, and the output power into a 50-ohm load (out-





put control at maximum) is approximately one watt. The output falls off at the upper and lower ends of the frequency spectrum.

Output Impedance: 50 ohms at the AUDIO jack; between 20 and 80 ohms, depending on frequency, at the RF jack when the 250-ohm output control is at maximum.

Modulation: The RF range (15 kc to 50 Mc) can be internally amplitude-modulated at either 400 c or 1000 c at the two nominal modulation levels of 25% and 50%. There is no provision for external modulation.

Envelope Distortion: Less than 6% at the 50% modulation level; less than 3% at 25% modulation.

R-F Distortion: With the output terminated in a 50-ohm resistive load, the RF control at its maximum setting, rf distortion is 3.5% over most of the range; at the lower frequencies it is 7%.

AF Distortion: 5% at 400 and 1000 cycles.

Leakage: Stray fields at 1 Mc are less than 50µv per meter at two feet from the oscillator.

Controls: A switch for selecting between AUDIO (LINE, 400 c or 1000 c) and RF output (CW or MODULATED — 400 c, or 1000 c); a switch for selecting between HIGH and LOW modulation; a voltage divider for controlling the RF output; a range switch; a calibrated dial and a vernier dial for setting the radio frequency; a power switch.

Accessories Supplied: TYPE 874-R22 Coaxial Cable, TYPE 874-Q2 Adaptor, TYPE 874-C58 Cable Connector, TYPE 874-PB58 Panel Connector, TYPE TO-44 Adjustment Tool (mounted on rf shield cover), TYPE CAP-35 Power Cord, and spare fuses.

Mounting: Aluminum panel finished in crackle lacquer. Aluminum cabinet has wrinkle finish and is provided with carrying handles. Cabinet can be removed for relay-rack mounting.

Power Supply: 105 to 125 (or 210-250) volts at 40 to 60 cycles. The power input is about 30 watts.

Instrument will operate satisfactorily on power-supply frequencies up to 400 cycles.

Power input receptacle will accept either 2-wire (TYPE CAP-35) or 3-wire (TYPE CAP-15) power cord. Two-wire cord is supplied. For 3-wire, see page 237.

Tube Complement: Two 6AQ5's and one 6X4.

Terminals: TYPE 874 Coaxial Terminals are provided for both the AUDIO output and the RF output.

Dimensions: (Height) 7½ × (width) 21¾ × (depth) 11¼ inches, over-all.

Net Weight: 37½ pounds.

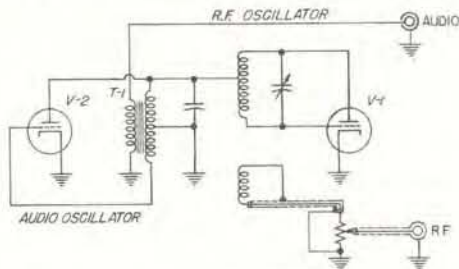

Type	Code Word	Price
1330-A Bridge Oscillator.....	ACORN	\$575.00

PATENT NOTICE. See Note 4, page x.

UNIT OSCILLATORS GENERAL RADIO'S LOW-COST, HIGH-QUALITY LINE

On the following seven pages are described General Radio Unit Oscillators.

These oscillators are efficient, well-shielded sources of power, built for maximum utility in the research laboratory, the production test department, or the college experimental class. They have wide frequency ranges with accurate calibration, provision for modulation, and higher-than-average, continuously variable output power. They are laboratory-quality

instruments with great adaptability and are offered at economy prices that help the laboratory budget.

Unit oscillators have moderate power requirements met easily by inexpensive Unit Power Supplies. The TYPE 1203-B Unit Power Supply is an efficient supply at low cost. The TYPE 1201-B Unit Regulated Power Supply is available for best performance through automatic regulation of plate voltage.

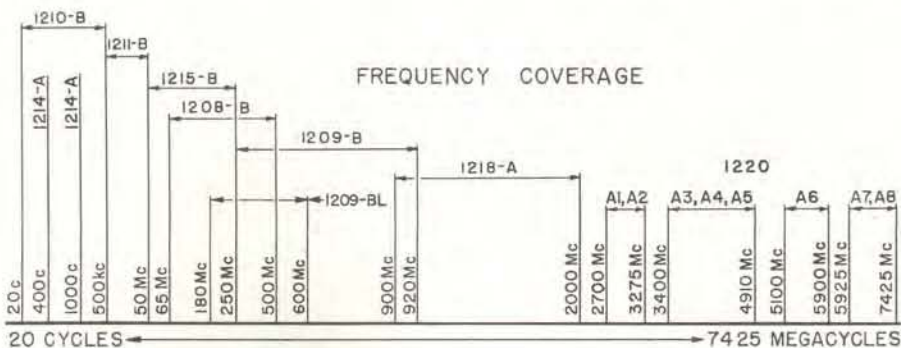



TYPE 1210-C UNIT R-C OSCILLATOR

USES: This compact, inexpensive oscillator offers outstanding performance per dollar and per cubic inch of space.

It can be used as:

- A power source for sine-wave measurements at audio, ultrasonic, and low-radio frequencies.
- A source of square waves for network steady-state and transient response measurements at audio, ultrasonic, and low-radio frequencies.
- A sine-wave or square-wave modulator for rf oscillators and standard-signal generators.
- A square-wave trigger for pulse generators.
- A swept oscillator for displaying amplitude-frequency characteristics: with the TYPE 908-P1 Synchronous Dial Drive or the TYPE 907-R Dial Drive for plotting the characteristics on a graphic recorder; or with the TYPE 908-P2 Synchronous Dial Drive for display on an oscilloscope.
- A high-power RC oscillator when combined with the TYPE 1206-B Unit Amplifier.

DESCRIPTION: The frequency of the oscillator is determined by an RC network. A fast-responding AVC system is used to hold the amplitude of oscillation constant in spite of changes in frequency or line voltage.

The oscillator provides three different outputs that contribute to its versatility and usefulness. A three-position switch selects any one of the following:

1. A low-impedance, low-voltage output

from a cathode-follower type of amplifier. This output has good waveform over its entire range of 0-7 volts for load impedances of 500 ohms and higher and has an effective output impedance of 50 ohms. It is applied directly to the 5000-ohm output control, calibrated in decibels, which yields a 50 to 1250-ohm output impedance. The calibration is useful with high-impedance loads and is reliable even at the lowest voltage levels, since the output is less than 3 millivolts when the control is at its extreme counter-clockwise position. Distortion is less than 1% over most of the frequency range.

2. A high-impedance, high-voltage output from a cathode-follower-driven triode amplifier. This output delivers up to 45 volts, open circuit, behind an impedance of 14 kilohms. Output impedance is constant, regardless of attenuator setting. Distortion is less than 5% over most of the range.

3. A square-wave output from a Schmitt circuit. This output furnishes square waves of 30-volt peak-to-peak amplitude (open-circuit) behind 2500 ohms, with $\frac{1}{3}$ μ sec rise-time and with approximately 1% overshoot. The rise time is reduced to about 0.15 μ sec when the output is loaded with a resistance of 1000 ohms.

When the oscillator is to be permanently mounted in the laboratory, it becomes a rack-mounted instrument in combination with the TYPE 480-P4U3 Relay-Rack Panel.





FEATURES:

- Very wide frequency range—audio, super-sonic, and radio frequencies.
- Sine- and square-wave output.
- Small size.
- Inexpensive.
- Sweepable.

- Fast-responding AVC system.
- Calibrated output control.
- Output constant with frequency.
- High output voltage.
- Precision frequency-control dial.
- Compact and rugged.

SPECIFICATIONS

Frequency Range: 20-500,000 c in 5 ranges: 20-200, 200-2000, 2000-20,000, 20,000-200,000, and 50,000-500,000 c.

Frequency Controls: Range selection switch and 4-inch precision gear-driven dial. Dial has two scales, 2-20 and 50-500, and is geared to a slow-motion knob that covers each decade in about 4 1/2 turns.

Frequency Accuracy: ±3%

Output Control: Logarithmic, calibrated 0-50 db.

Output System: 3-position panel switch for square-wave, sine-wave low-impedance, or sine-wave high-impedance output.

Low-Impedance Output: (for loads of 500 ohms and higher) 0-7 v, open circuit, constant within ±1 db up to 200 kc; internal output impedance 50 ohms at full output, 1250 ohms at half output; no-load distortion less than 1% from 200 c to 10 kc, less than 1.5% over entire frequency range. Hum is at least 60 db below output voltage level.

High-Impedance Output: (for loads of 10,000 ohms and higher) 0-45 v, open circuit, constant within ±1 db from 200 c to 150 kc; distortion less than 5% from 200 c to 200 kc, no load (reduced under load). Internal output impedance 14,000 ohms. Hum at least 50 db below maximum output voltage level.

Square-Wave Output: 0-30 v peak to peak; rise time approximately 1/3 μsec; overshoot approximately 1%; hum at least 60 db below output voltage level; internal output

impedance 2,500 ohms.

Output Terminals: Two jack-top TYPE 938 binding posts, one grounded to panel.

Tube Complement: One each 6BQ7-A, 0B2, 6189/12AU7-WA, 12AU7.

Power Requirements: 6.3 v ac or dc at 1 amp; 300 v dc at 50 ma.

Power Supply Recommended: TYPE 1203-B Unit Power Supply for operation from 115 v, 50-60 cycles.

The TYPE 1201-B Unit Regulated Power Supply will provide a slight improvement in frequency stability on the highest frequency range.

Instrument will operate satisfactorily on power-supply frequencies up to 400 cycles, with either power supply.

Mounting: Aluminum panel and chassis; bench mounting. The TYPE 480-P4U3 Relay Rack Adaptor Panel is available for use with oscillator and power supply combination. Panel height, 7 inches.

Accessories Available: For higher output (3 watts) use TYPE 1206-B Unit Amplifier (page 68); for oscilloscope display, TYPE 908-P2 Synchronous Dial Drive (page 151); for graphic recording, TYPE 907-R Dial Drive or TYPE 908-P1 Synchronous Dial Drive (page 151).

Dimensions: Panel, (width) 9 1/2, × (height) 5 1/4; depth behind panel, 5 1/8 inches.

Weight: 5 1/2 pounds.

Type		Code Word	Price
1210-C	Unit R-C Oscillator	ABAFT	\$180.00
1203-B	Unit Power Supply	ALIVE	40.00
480-P4U3	Relay-rack Panel (for mounting both 1210-C and 1203-B in one panel)	UNIPANCART	10.85

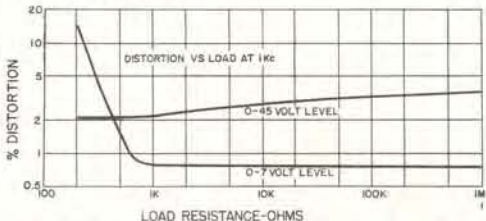
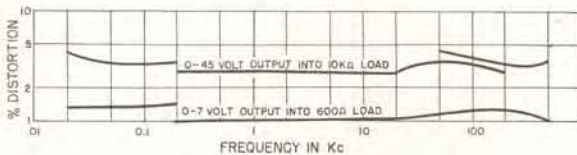
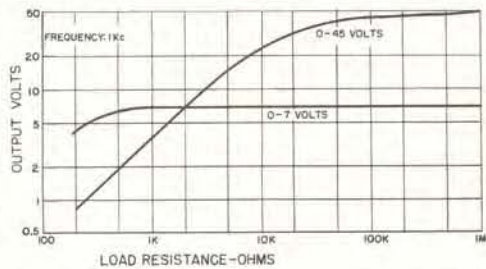
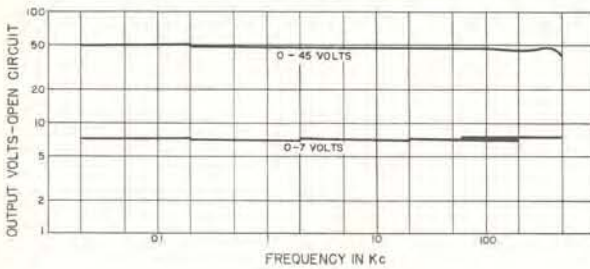

Typical output and harmonic distortion characteristics of the TYPE 1210-C Unit R-C Oscillator as functions of frequency and load.





TYPE 1214 UNIT OSCILLATORS



TYPE 1214-A

The TYPE 1214 Unit Oscillators are compact and inexpensive Unit oscillators generating fixed frequencies. The A-model generates frequencies of 400 and 1000 cycles; the D-model, 120 cycles; the E-model, 270 and 1000 cycles; and the M-model, 1 megacycle. A TYPE 1214 Unit Oscillator is a convenient modulator for the high-frequency unit oscillators and is useful as a power source for bridge measurements. The distortion is low, and the output level is higher than that of most small oscillators. The output can be isolated from ground for use of the oscillator as a modulator in the plate circuit of a high-frequency oscillator. Unlike most instruments of the Unit line, the power supply is built into the instrument.



TYPE 1214-D



TYPE 1214-E



TYPE 1214-M

SPECIFICATIONS

Type	1214-A	1214-D	1214-E	1214-M
Frequency	400 or 1000 c	120 c	270 or 1000 c	1 Mc
Accuracy	±2%	±5%	±2%	±1%
Max Output	200 mw into 8000 Ω	400 mw into 1, 5, 15, 150, 1500Ω (TYPE 1611-B Bridge)	300 mw into 800 Ω (TYPE 1661-A R-F Bridge)	300 mw into 50 Ω
Distortion	3% into 8000 Ω	3% into matched load	3% into 800 Ω	3.5% into 50 Ω
Power Input at 115 Volts	16 w	16 w	16 w	12 w
Tube	One 117N7-GT, which is supplied with the instrument			
Dimensions	Panel, (width) 4¾ × (height) 5¼; depth behind panel, 5⅛ inches.			
Weight	4½ pounds	4½ pounds	4½ pounds	2¾ pounds

Power Supply: 105 to 125 volts, 50 to 60 cycles. Instrument will operate satisfactorily on power-supply frequencies up to 400 cycles.

Accessories Supplied: Spare fuses; power cord is permanently attached.

Mounting: Aluminum cabinet and dust cover. Relay rack panel available.

Type		Code Word	Price
1214-A	Unit Oscillator, 400 and 1000 c	ALLAY	\$ 75.00
1214-D	Unit Oscillator, 120 c.....	ABBOT	100.00
1214-E	Unit Oscillator, 270 and 1000 c	ASSAY	75.00
1214-M	Unit Oscillator, 1 Mc.....	ATONE	75.00
480-P4U1	Relay Rack Adaptor Panel (for one oscillator)	UNIPANARCH	10.00





HF, VHF, and UHF UNIT OSCILLATORS

USES: These oscillators are compact, low-priced units that cover wide frequency ranges with single-dial control. Adequate power, coupled with good shielding, makes these oscillators well suited to drive bridges, slotted lines, and other impedance-measuring equipment. Their convenient adaptability makes them useful as general-purpose instruments for the laboratory, and their small size, simplicity, and low cost assure their usefulness in production applications.

General Radio unit oscillators cover all frequencies between 20 c and 2000 Mc, and barring a few small gaps, all frequencies from 2700 to 7425 Mc.

OUTPUT: The power output of these oscillators is between 100 milliwatts and 2 watts, as stated in the individual specifications. This power is adequate for practically all laboratory measurements with bridges, slotted lines, admittance meters, tuned circuits, etc.

TERMINALS: Output terminals are TYPE 874 Coaxial Connectors for convenient connection to General Radio measuring equipment and coaxial elements. Adaptors that permit interconnection with other standard coaxial connectors are also available. (See page 58).

POWER SUPPLY: Unit Oscillators have moderate power requirements met easily by inexpensive Unit power supplies. They are designed to operate from the TYPE 1203-B Unit Power Supply (see page 142). These oscillators can be used with other power supplies, but less than maximum output will be obtained.

SWEEP APPLICATIONS: Adaptability to sweeping techniques is another convenience of these instruments. They can be swept over fixed ranges of dial arc by sweep drives at either fast speeds for oscilloscopic display or slow

speeds for recorder applications. For sweep applications, the TYPE 1263-A Amplitude Regulating Power Supply is recommended.

MODULATION: Amplitude modulation over the audio range can be obtained by superimposing a-f voltage on the plate supply. The audio source must be capable of carrying the dc plate current of the oscillator. The TYPE 1214 Oscillators are recommended as modulators. Incidental fm inherent in this system is of the order of 0.01% for 30% am in the lower part of the tuning range and increases rapidly at the high-frequency end.

With the TYPE 1000-P7 Balanced Modulator the output of the Unit Oscillators (above 60 Mc) can be modulated up to 100% with sinusoidal or pulse waveforms, and rise times as short as 0.02 μ sec can be obtained. For video modulation the TYPE 1000-P6 Crystal Diode Modulator can be used.

ASSEMBLIES: These oscillators can be used with TYPE 874 Coaxial Elements to assemble a wide variety of systems, such as detectors, signal generators, pulsed oscillators, etc., which would otherwise require more specialized and expensive equipment.

The diagram below shows some of the accessories used with Unit Oscillators for building-block assemblies. For more complete listings of accessories see:

Coaxial Elements	pp 48-56
Connectors and Adaptors	pp 57-58
Dial Drives	pp 149-152
Modulators	pp 96-98
Other Unit Instruments	pp 201-202
Power Supplies	pp 142-145
Sweep Drives	pp 149-152

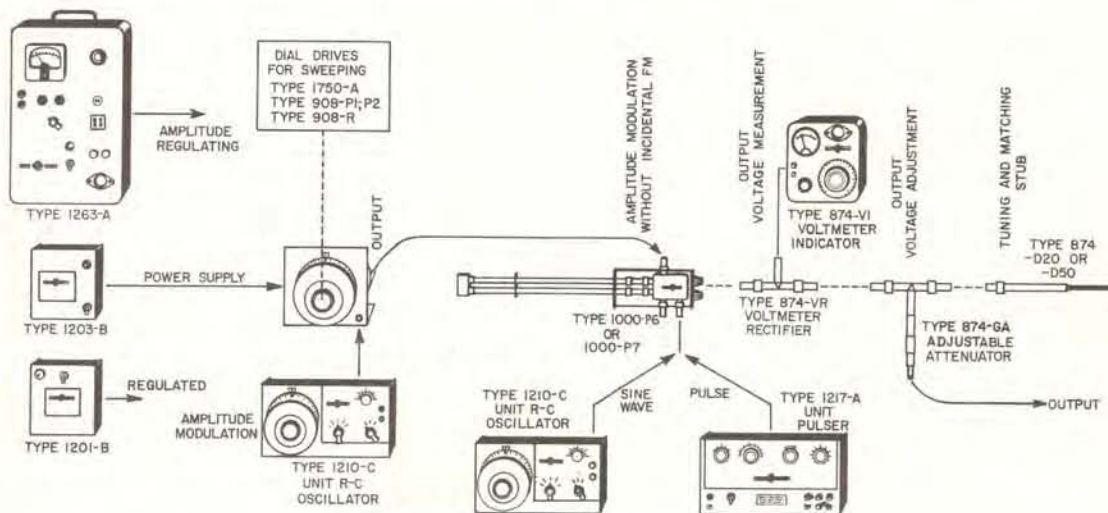

GENERAL SPECIFICATIONS

Output System: Short coaxial line with adjustable coupling loop at one end, and a TYPE 874 Coaxial Connector on the other. Maximum power can be delivered to load impedances normally encountered in coaxial systems.

Mounting: Oscillator is mounted in an aluminum casting,

and is shielded with a spun-aluminum cover. The assembly is mounted on an L-shaped panel and chassis.

Accessories Supplied: TYPE 874-R22 Patch Cord, TYPE 874-C58 Cable Connector, TYPE 874-PB58 Panel Connector, Multipoint Connector, and Telephone Plug.





HF, VHF, AND UHF UNIT OSCILLATORS



Oscillator Type No.	TYPE 1211-B	TYPE 1215-B	TYPE 1208-B
Frequency Range	0.5-50 Mc in 2 ranges	50-250 Mc	65-500 Mc
Tuned Circuit	LC Circuit	Semi-Butterfly with no sliding contacts.	Sliding Contact
Frequency Control	6-inch TYPE 908 dial with calibration over 180 degrees. Precision drive with vernier scale.	6-inch TYPE 908 dial with calibration over 140 degrees. Precision drive, with vernier scale.	4-inch TYPE 907 dial with calibration over 270 degrees. Precision drive.
Frequency Calibration Accuracy	± 2% at no load	± 1% at no load.	± 2%
Warm-Up Frequency Drift	0.5%	0.4%	0.5%
Output Power Into 50-ohm Load*	With 1201-B 300v Regulated Power Supply	1200 mw (0.5-5 Mc) 400 mw (5-50 Mc)	60 mw
	With 1203-B Power Supply	1500 mw (0.5-5 Mc) 500 mw (5-50 Mc)	100 mw
Amplitude Modulation	Sine-Wave	25% from 45 volts into 8000 ohms; use TYPE 1210 or TYPE 1214.	30% at 40 volts into 8000 ohms; use TYPE 1210 or TYPE 1214.
	Square-Wave	No	No
	Pulse	No	No
Sweep Drive	With TYPES 908-P1 and P2 Synchronous Dial Drives TYPE 907-R and 908-R Dial Drives, or TYPE 1750-A Sweep Drive—Pages 149 to 152.		
Amplitude Control For Constant Output	With TYPE 1263-A Power Supply.	With TYPE 1263-A Power Supply.	Not Recommended.
Power Supply Required Unit Power Supplies (p. 143) are recommended.	300-volts, dc, at 50 ma; 6.3 volts ac or dc at 0.75 ampere.	350-volts d-c at 25 ma and 6.3 volts a-c at 0.3 ampere.	320-volts d-c at 40 ma and 6.3 volts a-c at 0.9 ampere.
Will operate from 400-Cycle Supply with Type 1201-B or 1203-B	Yes	Yes	No
Tube	5763 Miniature UHF Beam Power Amp.	12AT7 Miniature Twin-Triode.	2C43 Lighthouse Triode.
Over-All Dimensions	7 × 8 × 12"	7 × 8 × 9½"	6¼ × 6¼ × 8¼"
Net Weight	11½ lbs.	7½ lbs.	5½ lbs.
Code Word	ATLAS	ADOPT	AMEND
Price	\$275.00	\$190.00	\$210.00

*Output at least as great as this can be obtained at any frequency within the range of the oscillator; over most of the frequency range of each oscillator, maximum output is greater. When the TYPE 1210-A Unit IF Amplifier is used as a power supply, output will be less than these values.

RELAY-RACK ADAPTOR PANELS

For Oscillator Only

For Oscillator and TYPE 1203-B (or TYPE 1201-B) Power Supply	480-P5UC1	480-P5UC1	480-P4UC1
	Height 8¾"	Height 8¾"	Height 7"
Code Word	UNIPANGOLF	UNIPANGOLF	UNIPANDOCK
Price	\$15.00	\$15.00	\$12.00

PATENT NOTICE: See Notes 4 and 10, page x.





HF, VHF, AND UHF UNIT OSCILLATORS



Oscillator Type No.		TYPE 1209-BL	TYPE 1209-B	TYPE 1218-A
Frequency Range		180-600 Mc	250-920 Mc	900-2000 Mc
Tuned Circuit		Butterfly, with no sliding contacts.	Butterfly, with no sliding contacts.	Line sections with sliding contacts.
Frequency Control		4-inch TYPE 907 dial with calibration over 270 degrees. Precision drive.	4-inch TYPE 907 dial with calibration over 270 degrees. Precision drive.	6-inch TYPE 908 dial with calibration over 200 degrees. Precision drive with vernier scale.
Frequency Calibration Accuracy		± 1%	± 1%	± 1%
Warm-up Frequency Drift		0.2%	0.2%	0.1%
Output Power Into 50-ohm Load*	With 1201-B 300v Regulated Power Supply	180 mw	120 mw	140 mw
	With 1203-B Power Supply	300 mw	200 mw	200 mw
Amplitude Modulation	Sine-Wave	30% at 40 volts into 8000 ohms; use TYPE 1210 or TYPE 1214.	30% at 40 volts into 8000 ohms; use TYPE 1210 or TYPE 1214.	Incidental fm is high.
	Square-Wave	No	No	100 to 500 c Use TYPE 1210.
	Pulse	No	No	Use TYPE 1217-A & TYPE 1219-A, or TYPE 1391-A.
Sweep Drive		With TYPES 908-P1 and P2 Synchronous Dial Drives TYPE 907-R and 908-R Dial Drives, or TYPE 1750-A Sweep Drive—Pages 149 to 152.		
Amplitude Control For Constant Output		With TYPE 1263-A Power Supply.	With TYPE 1263-A Power Supply.	With TYPE 1263-A Power Supply.
Power Supply Required Unit Power Supplies (p. 143) are recommended.		320-volts d-c at 36 ma and 6.3 volts a-c at 0.4 amp.	325-volts d-c at 40 ma and 6.3 volts a-c at 0.4 ampere.	340-volts d-c at 30 ma and 6.3 volts, 0.3 ampere a-c.
Will operate from 400-Cycle Supply with Type 1201-B or 1203-B		Yes	Yes	Yes
Tube		Sylvania TYPE RT434	RT-434 Disc Seal Triode	5675 UHF Medium-mu Pencil Triode
Over-All Dimensions		7 × 6¼ × 9¼"	7 × 6¼ × 9¼"	12½ × 10⅜ × 9½"
Net Weight		6¼ lbs.	6¼ lbs.	14¾ lbs.
Code Word		ADMIT	AMISS	CARRY
Price		\$245.00	\$245.00	\$465.00

*Output at least as great as this can be obtained at any frequency within the range of the oscillator; over most of the frequency range of each oscillator, maximum output is greater. When the TYPE 1216-A Unit IF Amplifier is used as a power supply, output will be less than these values.

RELAY-RACK ADAPTOR PANELS

For Oscillator Only			TYPE 480-P7U1 Height 12¼"
For Oscillator and TYPE 1203-B (or TYPE 1201-B) Power Supply	480-P4UC2	480-P4UC2	
	Height 7"	Height 7"	
Code Word	UNIPANFORT	UNIPANFORT	UNIPANHUMP
Price	\$12.00	\$12.00	\$15.00





TYPE 1220-A UNIT KLYSTRON OSCILLATOR

USES: The Unit Klystron Oscillator generates frequencies between 2700 and 7400 megacycles. It can generate fixed frequencies or swept frequencies and can be amplitude modulated with either square waves or pulses, with very low incidental fm.

Because of its relatively high output, low cost, small size and rugged construction, it is equally useful in the laboratory, on the production line, and in classroom demonstrations. It is an excellent source for slotted-line measurements of impedance and VSWR, measurements of bandwidth, and attenuation meas-

urements on cables, lines, and pads.

DESCRIPTION: This instrument includes an adjustable, regulated source of repeller voltage, a Schmitt squaring circuit, a 1000-cycle RC oscillator, and a socket for a reflex klystron tube. Klystron cathode current is furnished by an external Unit Power Supply.

Eight plug-in klystrons cover the frequency range. The oscillator is listed with each single klystron; additional klystrons can be ordered as desired.

Klystron frequency can be adjusted readily by a screw adjustment at the rear.

SPECIFICATIONS

Frequency Range: Depends on klystron tube used (see table below); frequency range of any unit can be changed to that of any other by inserting the appropriate klystron tube.

Amplitude Modulation:

Internal: 1-kc square wave, adjustable ± 15 cycles.

External: Square wave: 50 c to 200 kc; sine or square-wave modulating signal of at least 15 v rms required—TYPE 1210-C R-C Oscillator recommended.

Pulse: 1 to 10,000 μ s duration, less than 0.2 μ s rise and fall time, 50 c to 200 kc repetition rate; at least 20v peak pulse voltage required—TYPE 1217-A Unit Pulser recommended.

Frequency Modulation: at least 15 Mc excursion obtainable with less than 3 db change in output;—at 60 c, an rms input of the order of 10v is suitable.

Output Connector: 50-ohm TYPE 874 Coaxial Connector. Adaptors to other connector types available. (See page 58).

Tube Complement: Klystron, as specified, for TYPES 1220-A1 through A-8; one 6AB4, one 5963, two 0A2.

Power Supply: TYPE 1201-B Unit Regulated Power Supply is recommended for high stability and minimum incidental fm (page 142); with this power supply the oscillator can be operated from a 400-cycle source provided that the line voltage is between 115 and 125 volts.

Accessories Recommended: Fixed attenuator pad for isolating oscillator from load (page 54); TYPE 874-VQ or-VR for facilitating tuning adjustments (page 50).

Dimensions: Panel, (width) $9\frac{1}{2}$ \times (height) $5\frac{1}{4}$; depth behind panel, $5\frac{1}{8}$ inches.

Net Weight: 6 pounds, with klystron.

Type	Klystron Oscillator with klystron, for	Nominal Output in Milliwatts	Code Word	Price	Tube Only Type	Code Word	Price
1220-A1	2700-2960 Mc	100	KAWUN	\$264.65	726-C	KLYSTRONAY	\$ 49.65
1220-A2	2950-3275 Mc	90	KATOO	282.90	6043	KLYSTROBEE	67.90
1220-A3	3400-3960 Mc	90	KATRE	275.75	2K29	KLYSTROSEE	60.75
1220-A4	3840-4460 Mc	75	KAFOR	322.15	2K56	KLYSTRODEE	107.15
1220-A5	4240-4910 Mc	100	KAFIN	271.45	2K22	KLYSTRONEE	56.45
1220-A6	5100-5900 Mc	80	KASIX	311.45	6115	KLYSTRONEF	96.45
1220-A7	5925-6450 Mc	100	KASET	282.90	QK404	KLYSTROGEE	67.90
1220-A8	6200-7425 Mc	90	KALOC	282.90	5976	KLYSTROJAY	67.90
1220-A	Without Tube		KANOT	215.00			
1201-B	Unit Power Supply		ASSET	85.00			
480-P4U3	Relay Adaptor Panel (Holds both oscillator and power supply)		UNIPANCART	10.85			

All klystron tubes except the 6043 are designed for relatively infrequent tuning. The oscillator will also operate with the TYPE 2K25 Klystron (8550-9660 Mc), and TYPE 2K26 (6250-7060 Mc).

PATENT NOTICE: See Note 4, page x.



PULSE AND NOISE GENERATORS



▶ PULSE AND TIME-DELAY GENERATORS

The rapid expansion of the electronics industry in the past fifteen years has been due as much to the rise of new fields as to the expansion of the older field of communications. Radar, long-distance navigation systems, electronic computation, and television are new areas in which high-speed switching and time measurements are fundamental tools. Starting with the development of the TYPE 869-A Pulse Generator for the Radiation Laboratory at the Massachusetts Institute of Technology in 1942, the General Radio Company has been continuously engaged in development work on pulse systems to provide science and industry with the best in equipment for the production of pulse waveforms for general laboratory applications.

Several quantities are important to the prospective purchaser of a pulse generator. The particular application will, of course, dictate which ones are of paramount importance:

- (1) The rise and decay times of the pulse
- (2) The range of time duration of the pulse
- (3) The range of pulse repetition rates
- (4) The peak pulse power
- (5) The output impedance of the generator
- (6) The maximum possible duty ratio (pulse duration divided by pulse repetition period.)
- (7) Stability and accuracy of these quantities.

In an ideal pulse generator, the pulse would rise and fall instantaneously, and the duration could range from zero to infinity in time. There should, of course, be no limit on repetition frequency, and thus an ideal duty-ratio figure would be unity.

Practical pulse generators must necessarily fall short of these ideal criteria. The transition times are generally limited by the bandwidth of the switch, mechanical or electronic, producing the pulse, and by the output coupling system connecting it to the load. Maximum repetition frequency is limited by the recovery transients of the pulse timing circuits and/or the maximum permissible duty ratio. The available pulse power is, in general, only limited by economic considerations of power supply and the output tubes, which must handle the average pulse power.

Under these constraints then, it is hardly surprising that no one pulse generator can adequately fill all possible applications. It is the intention of the General Radio Company to provide the industry with a line of pulse sources to meet every practical laboratory application.

Unit Pulser

The TYPE 1217-A Unit Pulser, with a large adjustment range of repetition frequency and pulse duration and a self-contained oscillator, is an economical pulse source for low-power applications and for systems of up to 5-Mc bandwidth. It is excellent for such diverse applications as amplifier square-wave testing, studies of the transient response of networks, and as a pulse-frequency source for the driving of high-power pulse sources.

Pulse Amplifier

The TYPE 1219-A Pulse Amplifier can be driven by any convenient source of pulses to produce an output pulse of

current ranging up to 0.6 ampere. It provides adequate energy to drive pulsed oscillators and will develop up to 30 volts in a 50-ohm load. Maximum duty ratio is 50%, which makes the unit useful for the production of high-energy square waves. Rise and decay times as short as 0.03 microsecond can be produced. Brief triggers at a low impedance can be produced for testing the performance and resolution of trigger circuits and delay lines in the megacycle range.

Pulse, Sweep, Time-Delay Generator

The TYPE 1391-B Pulse, Sweep, and Time-Delay Generator is our most versatile pulse instrument. The rise and decay times for the push-pull output are both .015 microsecond, and the pulse duration ranges from .025 microsecond to 1.1 seconds. There are no duty-ratio restrictions even though pulse current of .15 ampere is available to the load. Switched internal loads of 50 to 600 ohms are available.

An internal, wide-range, precision time-delay generator of high resolution and stability produces a delayed trigger pulse ranging from 1 microsecond to 1.1 seconds; coincidence circuitry is included for easy recalibration and complex synchronization. A wide variety of switching and external connection possibilities make this generator applicable to almost any conceivable laboratory application where pulses and time delays are desired.

Time-Delay Generator

The TYPE 1392-A Time-Delay Generator extends the wide range delay concept first introduced in the 1391-A. It comprises a 1 μ sec to 1 sec delay circuit of high accuracy and stability, a 0-1 μ sec variable delay line, and a second six decade circuit producing delays from 0.5 μ sec to 0.5 sec. These three units can be switched to perform many functions such as:

(1) Production of precise delays (0-1 μ sec) with .004 μ sec resolution and .010 μ sec absolute accuracy.

(2) Double delay generator with the two 6-decade delay circuits either in series or in parallel.

(3) An extremely versatile gating and time selection coincidence system in which the 0.5- μ sec to 5-sec circuit is used as a gate whose initiation time is controlled by the 0-1 sec delay circuit.

In addition to 0.1 μ sec, 20 volt, synchronizing pulses for all circuits, the delay intervals are marked by gate waveforms.

▶ RANDOM NOISE GENERATOR

The use of "white" noise as a tool in the measurement and test of electronic systems is another important modern development. The concept of wide-band testing, as contrasted to point-by-point measurements, saves valuable engineering time and often leads to more significant results. The TYPE 1390-A Random Noise Generator, described on page 125, is a well-designed source for these tests at frequencies between 20 c and 5 Mc.





TYPE 1391-B PULSE, SWEEP, AND TIME-DELAY GENERATOR

USES: The TYPE 1391-B Pulse, Sweep and Time-Delay Generator is a versatile laboratory instrument designed to generate

(1) push-pull pulses, of durations from 0.025 μ sec to 1.1 sec and repetition rates up to 250 kc;

(2) linear sweep voltages of durations from 3 μ sec to 0.12 sec;

(3) time delays from 1 μ sec to 1.1 sec; and

(4) direct and delayed trigger pulses, which can be used independently or to delay the initiation time of the sweep and main pulse relative to the input driving signal. Transition times of the output pulses (0.015 μ sec rise time) are compatible with most present-day oscilloscopes. The internal sweep circuit makes possible the use of an inexpensive oscilloscope by direct connection to the deflection plates.

Among its many applications are measurement and testing in the fields of:

Echo ranging	Computers
Radio navigation	Telemetry
Television	Physiological research

DESCRIPTION: The system block diagram outlines the over-all operation of the generator, which includes the following basic circuits:

Input Circuits are driven by an external signal (which may have any wave shape, sine

wave, square wave, pulse, etc.), from which they produce the direct synchronizing signal, which is available at panel terminals. These signals occur at either a positive-or a negative-going zero crossing of the input signal, as determined by a switch setting.

Delay Circuits produce delayed trigger and synchronizing signals, with delay adjustable from 1 μ sec to 1.1 seconds. A coincidence circuit is provided, by means of which, optionally, multiple delayed trigger and synchronizing signals are produced from pulses introduced at the coincidence drive terminals.

Sweep Circuits can be started by either direct or delayed trigger to produce

(1) a positive and a negative voltage rising linearly to 135 volts in a time adjustable in steps from 3 μ sec to 0.12 sec.

(2) Positive and negative gate signals with the same duration as the sweep.

Pulse Timing Circuits determine the formation times of the triggers that start and stop the output pulse. Their delay and duration relative to the sweep are adjustable. By means of switching, the output pulse is started and stopped by

(1) Internally generated signals, which are also available at panel terminals for synchronizing external systems,





- (2) Externally generated driving pulses, or
- (3) Internally generated pulses added to externally applied pulses to produce multiple pulses at different durations.

Pulse Source Circuits comprise a bistable system which responds to the start and stop triggers to produce push-pull output pulses of adjustable amplitude and with adjustable output impedance.

FEATURES:

- Extremely wide ranges of pulse duration and delay.
- No duty-ratio restrictions.
- Low jitter—high accuracy.
- Variable output impedance, 0–600 ohms.
- Pulse-forming and delay circuits stable against hum and line transients.
- Coincidence circuitry makes possible multiple pulsing and time selection.

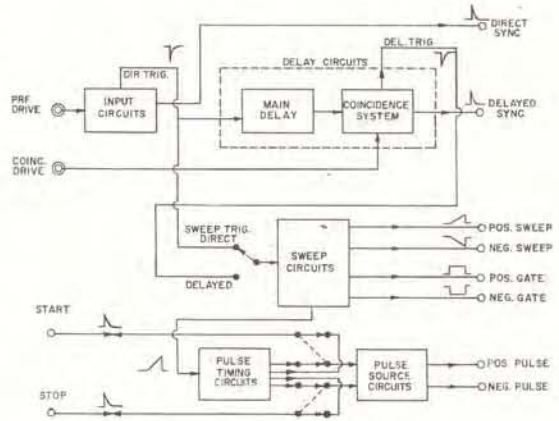

Block diagram of TYPE 1391-B Pulse Sweep, and Time-Delay Generator.

- Push-pull pulse, sweep, and sweep-gate circuits.

SPECIFICATIONS

Input Synchronizing Signal: Signals of almost any shape will trigger the input timing circuits.

Typical input signal minimum amplitudes are:

- (1) Sine wave 0.1 volt, rms.
- (2) Square waves 0.3 volt, peak-to-peak.
- (3) Brief positive pulse 1.0 volt, peak-to-peak.
- (4) Brief negative pulse 1.0 volt, peak-to-peak.

Switch for a-c or d-c input and triggering threshold controls are provided.

Direct Synchronizing Pulse

Polarity-positive amplitude: 75 volts.
Duration: ($\frac{1}{2}$ amplitude) 1 μ sec.
Output Impedance: 600 ohms.
Repetition Rate: Amplitude constant to 300kc; down 20% at 500kc.

Time-Delay Circuit

Range: 1.0 μ sec to 1.1 sec in six ranges.
Delay Dial Calibration: 1.00 to 11.00 in 1000 divisions.
Delay Dial Resolution: 1 part in 8800.
Accuracy: Absolute, $\pm 2\%$ of full scale, or $\pm 3\%$ of scale reading + 0.05 μ sec, whichever is larger; incremental delay, $\pm (1\% + .05 \mu$ sec).
Maximum PRF: 400 kc.

Duty Ratio Effects: Less than 2% error in delay for duty ratios up to 60%, at the low end of each range, and up to 90% at the high end of each range.

Delayed Synchronizing Pulse Characteristics: Positive, 60 v, 1.0- μ sec half-amplitude duration, 600-ohm cathode-follower output.

Stability:	Low End of Dial	High End of Dial
Time Jitter	1:10,000	1:50,000
10% Line Change	2:1000	2:10,000
Sudden 10% Line Transient	3:1000	3:10,000

Coincidence Circuits

Gate Duration: 3 to 1000 μ sec.
Gate Accuracy: $\pm 15\%$ or $\pm 1 \mu$ sec, whichever is larger.
Coincidence driving circuit will accept either positive or negative input pulses. Source impedance should be low, have rise time less than 0.2 μ sec. Amplitudes between 5 and 20 volts are acceptable for negative pulses, and between 10 and 100 for positive pulses.

Sweep Circuit

Sweep Duration: 3, 6, 12 μ sec with 5-decade multiplier.
Sweep Linearity: Determined by the accuracy of pulse timing. On longer ranges, where time delay effects are absent, the linearity is better than 1%.
Sweep Amplitude: Push-pull, each phase, 135 volts, nominal. Cathode-Follower output, 1- μ f blocking capacitors.
Sweep Gate Amplitude: Push-pull, each phase 40 volts nominal.
Positive sweep gate is cathode-follower output circuit with a 1- μ f coupling capacitor. Negative gate is amplifier output with 1- μ f blocking capacitor.
Duty Ratio and Repetition Rate Effects: Maximum repetition rate, 3- μ sec sweep, 250 kc.

Range Maximum Frequency for 5% Error in Sweep Slope

Sweep Time	3 μ sec	6 μ sec	12 μ sec
$\times 1$	150 kc	100 kc	60 kc
$\times 10$	16 kc	12 kc	7 kc
$\times 10^2$	1.6 kc	1.2 kc	700 c
$\times 10^3$	160 c	120 c	70 c
$\times 10^4$	16 c	12 c	7 c

Pulse Generating Circuit

Pulse Duration: (Timed by sweep) 0.025 to 2.5, 0.05 to 5.0 and 0.05 to 10.0 between half amplitude points, with decade multipliers to a maximum of 100,000 μ sec. Pulse

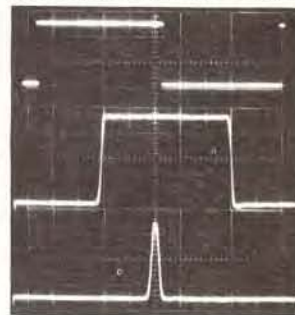

50- μ sec pulse (10 μ sec/cm)

0.5 μ sec pulse (0.1 μ sec/cm)

Minimum pulse (0.1 μ sec/cm)

Typical pulse waveforms; generator applied directly to scope deflection plates.





the long delays make it a very desirable instrument. It can be used for the measurement of short time intervals and other quantities that can be translated into time variables.

DESCRIPTION: An external signal voltage of almost any wave-shape will set the PRF. A direct synchronizing pulse of 0.1-μsec duration is generated at this frequency and becomes the time reference for the instrument. Two delay circuits provide delays relative to this reference sync pulse of from 0 to 1.1 seconds and from 0.5 μsec to 0.5 second, respectively. Each delay circuit generates a brief (0.1 μsec) synchronizing pulse at a time determined by its control settings. Delay No. 1 is always initiated by the direct synchronizing pulse. Delay No. 2 can be initiated by either the direct synchronizing pulse or the Delay No. 1 synchronizing pulses. Thus, the two delays can be operated "in series", (adding in delay times) or "in parallel", producing two independent delays.

Delay No. 1 uses a passive variable delay line with a precisely calibrated dial to produce a delay variable from 0 to 1 μsec in 10-mμsec divisions. This delay line serves either as a

first (0-1 μsec) range for Delay No. 1 or as a vernier on the 1-μsec to 1.1-sec electronically produced delay. Other features of Delay No. 1 in addition to its range are: high accuracy, resolution, linearity and stability against noise, aging, and power line effects.

Delay No. 2, in addition to its use as an independent delay circuit, provides the feature of time selection. When used to operate the built-in coincidence circuitry, pulses from a timing comb coherent with the PRF drive can be selected to provide precise delays independent of internal error or drift within the 1392-A. The 0.5-μsec minimum delay of Delay No. 2 permits the selection of a single 1-μsec pulse from a 1-Mc train so that 1-μsec steps of delay are provided. In addition, the coincidence feature provides for the production of bursts of pulses.

FEATURES:

- High accuracy, high resolution, high stability.
- Linear scales at all delays.
- Two delay outputs.
- Wide range.

SPECIFICATIONS

INPUT SYSTEM

Voltage:

- Sine Wave, 0.1 volts rms.
- Square Wave, 0.3 volt, peak-to-peak.
- Pulse (negative or positive), 1 volt peak ac or dc, input trigger threshold control provided.

Frequency: dc to over 300 kc.

Time Delay (Input to direct sync): 0.12 ± 0.02 μsec.

Direct Sync Pulse:

- Amplitude, 15 volts or more, positive or negative.
- Duration, 0.13 ± 0.02 μsec.
- Impedance, 93 ohms or less.

DELAY NO. 1

Delay Range: 0-1.1 sec in seven ranges.

Accuracy: 1 μsec-1.1 sec range, ±1% of dial reading; 0-1 μsec range, ±0.01 μsec.

Stability: Jitter, 1:30,000 at worst. Drift, 1:10,000 with 20% line variations.

Resolution: 0-1 μsec 0.004 μsec.

1 μsec-1 sec 1:8800.

Duty Ratio Effects: Less than dial accuracy to 60% 5% at duty ratio of 80%.

DELAY NO. 1 SYNC

Duration: 0.1 ± .02 μsec.

Amplitude: 25 volts or more positive or negative.

Impedance: 93 ohm output impedance
Monitor Lamp NE-2.

Max PRF: 0-1 μsec range, 300 kc;
1 μsec-1.1 sec range, 250 kc (at 1 μsec).

DELAY NO. 2, OR COINCIDENCE CIRCUIT

Range: 0.5 μsec-0.5 sec (six decade ranges).

Accuracy: ±3% of dial reading.

Stability: Jitter, 1:20,000.

Line Drift, 1:5,000 for 20% line change.

Resolution: 1:2,000.

Delay No. 2 Sync:

- 0.13 μsec ± 0.02 μsec.
- 20 volts or more, positive or negative.
- 93 ohms.
- Monitor Lamp.

Duty Ratio Effects: Full scale, less than dial accuracy at 60% duty ratio; bottom of scale, less than dial accuracy at 20% duty ratio. Max. PRF 300 kc.

Coincidence:

- Input, positive or negative pulse, 5 volts or over.
- Input frequency, 1 cps to 1.7 Mc (for single pulse selection).

Input pulse rise time, 0.1 μsec or less at 5 v.

Power Supply: 105 to 125 (or 210 to 250) volts, 50-60 cycles, 180 watts at 115 volts. Power receptacle will accept either 2-wire (TYPE CAP-35) or 3-wire (TYPE CAP-15) Power Cord. Two-wire cord supplied.

Dimensions: Panel, 19 × 8¾ inches; depth behind panel, 13 inches.

Accessories Supplied: TYPE CAP-35 Power Cord; spare fuses; test lead; 4 TYPE 874-C58 Cable Connectors.

Net Weight: 35 pounds.

Type		Code Word	Price
1392-AM	Time-Delay Generator (Bench Model)	ENTRY	\$985.00
1392-AR	Time-Delay Generator (Relay-Rack Model)	EXTOL	985.00

PATENT NOTICE, See Note 4, page 5.





TYPE 1217-A UNIT PULSER

USES: The Unit Pulser is a compact, versatile and inexpensive source of pulse waveforms for the laboratory. The pulser is useful in transient studies on passive networks, square-wave testing of amplifier systems, and as a source of pulse-modulation voltage for R-F signal generators and oscillators.

An internal oscillator makes the unit independent of external synchronizing signals for most applications. The Unit Pulser can also be used as a simple time-delay generator over its range of available pulse durations. One pulser may be used to delay the trigger pulse for a second unit.

DESCRIPTION: Four basic circuits, a blocking oscillator, a monostable multivibrator, a limiter, and a cathode-follower, phase-splitter output stage, are employed in the Unit Pulser.

The blocking oscillator provides the internal repetition frequencies, and its voltage is used to speed up the leading edge of the pulse. The multivibrator produces the adjustable-duration pulse. The limiter is used to remove imperfections in the pulse and to prevent amplitude variations with repetition rate and duration. The cathode-follower phase-splitter output system, provides either positive or negative output pulses.

FEATURES:

- Wide range of pulse durations and repetition rates.
- Fast rise time—0.05 μ sec.
- Repetition rate can be set by external source, if desired.
- Pulse duration settings stable and accurate.
- Internal time delay of 1/10 μ sec permits leading edge of pulse to be visible on scope.

SPECIFICATIONS

Pulse Repetition Rates: 30 c, 60 c, both synchronized to power line; 100 c to 100 kc in 1-2-5 steps, $\pm 15\%$ or 20 c whichever is greater; 15 c to 100 kc continuous with external source.

Pulse Duration: Continuous coverage in four ranges 0.2 to 60,000 μ sec. Accuracy $\pm 15\%$ or 0.2 μ sec, whichever is greater.

Pulse Shape: Rise time 0.05 μ sec, decay time 0.15 μ sec with output terminals shunted by 15 μ mf and 1 M Ω . Overshoot may be set to be less than 5% of one-half the maximum amplitude; top of pulse is flat to within 5% of maximum amplitude.

Minimum External Drive Voltage: 25 volts or less, rms, for continuous locking up to 100 kc; a 10-volt pulse will lock continuously from 0 to 25 kc. TYPE 1210-C Unit R-C Oscillator is recommended.

Output Impedance: 200 ohms for positive pulses, 1500 ohms for negative pulses.

Open Circuit Output Voltages: 20 volts for pulses of either

polarity; negative pulse of 50 volts when positive output terminal is grounded.

Stability: No time jitter is visible where a full period is displayed on an oscilloscope.

Tube Complement: 6AK5, 6AN5, 6AL5, 6485 and two 12AT7.

Accessories Supplied: One multipoint connector, 10:1 200 Ω attenuator.

Power Supply: 300 volts, dc, 55 ma; 6.3 volts, ac, 60 cycles, 2 a. TYPE 1203-B Unit Power Supply is recommended. AC filament supply is necessary to synchronize the 30- and 60-cycle pulse repetition frequencies. The pulser can be used on other supply frequencies up to 400 cycles, but the 30- and 60-cycle PRF positions will not be synchronous. A 50-cycle model, TYPE 1217-AS1, is listed below.

Dimensions: Panel, (width) 9 $\frac{1}{2}$ \times (height) 5 $\frac{1}{4}$; depth behind panel, 5 $\frac{1}{8}$ inches.

Net Weight: 5 $\frac{1}{4}$ pounds.

Type		Code Word	Price
1217-A	Unit Pulser	AMASS	\$235.00
1203-B	Unit Power Supply	ALIVE	40.00
1217-AS1	Unit Pulser (50 cycles)	AMASSPASHA	250.00
480-P4U3	Relay Rack Adaptor Panel (7 in. high)	UNIPANCART	10.85





TYPE 1219-A PULSE AMPLIFIER

Used with any pulse source, this amplifier produces pulses with many different characteristics of duration, duty ratio, and impedance level at higher power levels. The amplifier may be driven by either positive or negative input pulses and produces output pulses of either polarity. The combination of Unit Pulser and Unit Pulse Amplifier constitutes a high power output pulse generator of very moderate cost and small size. The Pulse Amplifier is equally useful with TYPE 1391-B Pulse, Sweep, and Time-Delay Generator.



SPECIFICATIONS

Output Pulse: Open circuit voltage is between 10 and 250 volts, and is the product of impedance and available current listed below:

(1) Impedance:

- a. Positive Pulse: 50, 75, 100, 150 ohms all $\pm 10\%$.
- b. Negative Pulse: 50, 75, 100, 150, 200, 250, 300 ohms, all $\pm 10\%$; 570 ohms $\pm 20\%$ designed to permit maximum output voltage.

(2) Output Current in milliamperes:

Duty Ratio	Positive Pulse		Negative Pulse	
	DR Sw 0.2	DR Sw 0.5	DR Sw 0.2	DR Sw 0.5
0.05	620 $\pm 10\%$	350 $\pm 15\%$	575 $\pm 10\%$	330 $\pm 15\%$
0.2	560 $\pm 10\%$	300 $\pm 15\%$	475 $\pm 10\%$	275 $\pm 15\%$
0.5		250 $\pm 15\%$		225 $\pm 15\%$

(3) Rise and Decay Times: See table below.

(4) Pulse Shape: Less than 5% overshoot.

(5) Noise: Hum less than 1% of amplitude.

(6) Maximum duration to 10% droop: The droop is approximately linear with increasing pulse duration.

Input Pulse			Output Characteristic				Output Switch Setting
Polarity	Amplitude	Rise and Decay Time	Duty Ratio Sw 0.2		Duty Ratio Sw 0.5		
			Rise Time	Decay Time	Rise Time	Decay Time	
Negative (Minimum necessary drive)	30 v	2 μ sec.	50 μ sec.	30 μ sec.	40 μ sec.	20 μ sec.	Negative, 50 Ω
Negative	30 v	50 μ sec.	50	50	60	50	Negative, 50 Ω
			100	100	30	90	Negative, 570 Ω
			80	80	60	70	Positive, 50 Ω
Negative	50 v	1217-A Pulser	60	90	40	80	Negative, 50 Ω
			100	120	90	110	Negative, 370 Ω
			90	120	70	100	Positive, 50 Ω
Positive	2.5 v	1217-A Pulser	180	160	120	130	Positive, 150 Ω
			60	240	40	160	Negative, 50 Ω
			110	240	80	160	Negative, 370 Ω
Positive	25 v	1217-A Pulser	90	180	80	160	Positive, 50 Ω
			180	240	130	160	Positive, 150 Ω
			50	80	40	60	Negative, 50 Ω
(Pulse stretching 0.3 μ sec.)			90	110	100	100	Negative, 370 Ω
			90	110	60	80	Positive, 50 Ω
			180	150	110	100	Positive, 150 Ω

Type		Code Word	Price
1219-A	Unit Pulse Amplifier	ACRID	\$200.00
480-P4U2	Relay Rack Adaptor Panel (7 inches high)	UNIPANBOLT	10.00

PATENT NOTICE. See Note 4, page v.

Input	Positive Output	Negative Output
Negative 30 v	2000 μ sec.	4000 μ sec.
Negative 55 b	10,000	4000
Positive 10 v	10,000	6000

(7) Maximum Repetition Rate: No high-frequency limit; see duty-ratio restrictions.

Input Impedance: Positive input, 50 kilohms shunted by 30 μ f; negative input, 5 kilohms and 30 μ f.

Note: Under some conditions, particularly for a brief output pulse, with positive driving pulses, and where best output pulse shape and minimum jitter of pulse trailing edge are desired, the input driving pulse must be floated relative to the amplifier chassis ground.

Tube Complement: One 6J6, one 12AU7, two 5763.

Accessories Supplied: One TYPE 874-C58 Cable Connector; spare fuses.

Power Supply: 105 to 125 or 210 to 250 volts, 50 to 60 cycles. 75 watts. Operation on supply frequencies up to 400 cycles is possible, with reductions in pulse output current up to 10%.

Dimensions: Panel, (width) 9 $\frac{1}{2}$ \times (height) 5 $\frac{1}{4}$; depth behind panel, 5 $\frac{1}{8}$ inches. **Net Weight:** 8 $\frac{1}{2}$ pounds.





TYPE 314-S86 VARIABLE DELAY LINE



USES: This variable delay line finds general application as a wide-band phase-shifting device, particularly when it is desired to delay a wide-band signal without introducing phase distortion. Thus, it is used as a component in pulse and in video-frequency systems such as

computers, radar and beacon systems, and television circuits.

DESCRIPTION: In this delay line, good transient response is obtained by a skewed-turn method of delay equalization*, in which the plane of each turn of the winding is at an acute angle to the axis of the coil. By careful control of the manufacturing process, the "baseline ripple", caused by variation in characteristic impedance along the line, has been reduced to 5% or less of the signal amplitude. End reflections have been minimized by the use of tapered capacitance elements at the ends of the winding. Materials are chosen for reliable operation under wide variations of temperature and humidity.

FEATURES:

- Delay is constant with frequency over a wide range.
- No ringing or overshoot.
- Characteristic impedance is uniform along the line.

*F. D. Lewis and R. M. Frazier, "A New and Better Variable Delay Line," *General Radio Experimenter*, 31, 7, October, 1956.

SPECIFICATIONS

Characteristic Impedance: 200 ohms $\pm 15\%$ at frequencies up to 4.5 Mc.

DC Resistance: Not over 20 ohms.

Delay vs. Frequency (with respect to delay at 1 Mc): $\pm 1\%$ at 10 Mc; $\pm 2\%$ at 15 Mc; $\pm 4\%$ at 20 Mc measured at maximum delay. See accompanying plot.

Amplitude Response vs. Frequency: Loss 9% (0.8 db) at dc;

30% (3 db) at 6 Mc; 60% (8 db) at 10 Mc; 90% (10 db at 25 Mc) at maximum delay. See also accompanying plot.

Pulse and Step Response: See accompanying oscillograms.

Dimensions: Diameter, $3\frac{3}{16}$ inches; depth behind panel, $1\frac{1}{2}$ inches; shaft diameter, $\frac{3}{8}$ inch; knob is furnished.

Net Weight: 6 ounces.

Type	Code Word	Price
314-S86 Variable Delay Line	DELAY	\$60.00

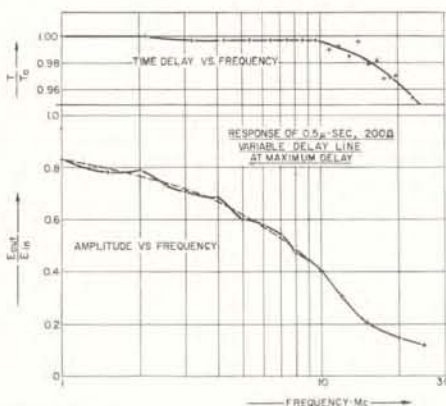

Time delay and amplitude versus frequency with resistive termination as measured at full delay on 0.5- μ sec, 200-ohm variable delay line with skewed winding.

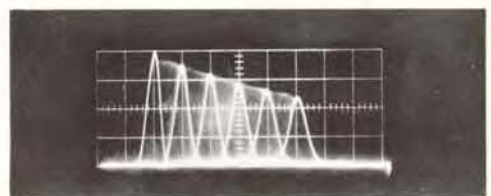

Oscillogram showing pulse shape and amplitude as delay setting is varied. Tektronix 541 Oscilloscope, 53K/54K Pre-Amplifiers; sweep, 0.1- μ sec/cm.

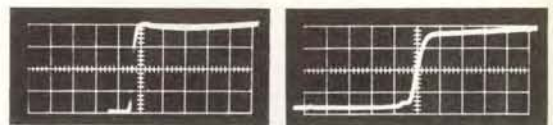

Step response of 0.5- μ sec, 200-ohm variable delay line with skewed winding; (left) step input, (right) step output at 0.5- μ sec delay. Scope photos taken on Tektronix 541, 0.1- μ sec/cm sweep.



TYPE 1390-A RANDOM-NOISE GENERATOR



USES: This instrument generates wide-band noise of uniform spectrum level, suitable for many types of electrical and mechanical testing.

In vibration testing, it is used, with suitable amplification, to drive shake tables for mechanical tests, and to drive loud speakers for tests under high-intensity sound fields.

In acoustics, it is used for tests on microphones and loud speakers, and for psycho-acoustic tests and room acoustic measurements.

In the electrical laboratory, it is used in measuring the characteristics of filters, in crosstalk measurements, and as a modulating source for radio-frequency standard-signal generators.

DESCRIPTION: A gas-discharge tube is used as a noise source in this generator. A magnetic field is applied to the tube to eliminate the oscillations usually associated with a gas discharge. The noise output is amplified in a

two-stage amplifier. Between the two stages of the amplifier, filters controlled by the range switch on the front panel of the instrument shape the noise spectrum three different ways. The 20-kc setting puts in a low-pass filter that has a gradual roll-off above 30 kc, with the audio range to 20 kc uniform in spectrum level. The 500-kc setting puts in a low-pass filter that rolls off above 500 kc. The 5-Mc setting puts in a peaking network that compensates for the drop in noise output from the gas tube at high frequencies, so that a reasonably good spectrum is obtained to 5 Mc.

FEATURES:

- Wide range of frequencies covered.
- High over-all output level.
- Output meter provided.
- Uniform spectrum level over the audio range.
- Wide range of output levels available using the TYPE 1390-P1 Voltage Divider as an output control (see next page).

SPECIFICATIONS

Frequency Range: (a) Range switch at 20 kc: uniform spectrum level from 30 c to 20 kc within ± 1 db.

(b) Range switch at 500 kc: uniform spectrum level from 30 c to 500 kc within ± 3 db.

(c) Range switch at 5 Mc: uniform spectrum level from 30 c to 500 kc within ± 3 db and from 500 kc to 5 Mc within ± 8 db.

Noise energy is present beyond these limits.

Output Voltage: Maximum open-circuit output voltage on any one of three bands is at least 1 volt rms. Average spectrum level for one-cycle band with 1 volt output is: 20-kc band, 6 millivolts; 500-kc band, 1 millivolt; 5-Mc band, 0.5 millivolt.

Output Impedance: Source impedance for maximum output is 900 ohms. The output is taken from a 2000-ohm potentiometer. One output terminal is grounded.

Waveform: A very good normal, or Gaussian, distribution of amplitudes for limited ranges of the frequency spectrum is provided by the gas-tube noise source. The amplitude limitations of a vacuum-tube amplifier modify this distribution slightly for the 20-kc range. Clipping occurs on the 500-kc and 5-Mc ranges.

Voltmeter: A rectifier-type, average meter is used for measuring the output voltage. It is calibrated to read the r-m-s value of the noise at the output terminals.

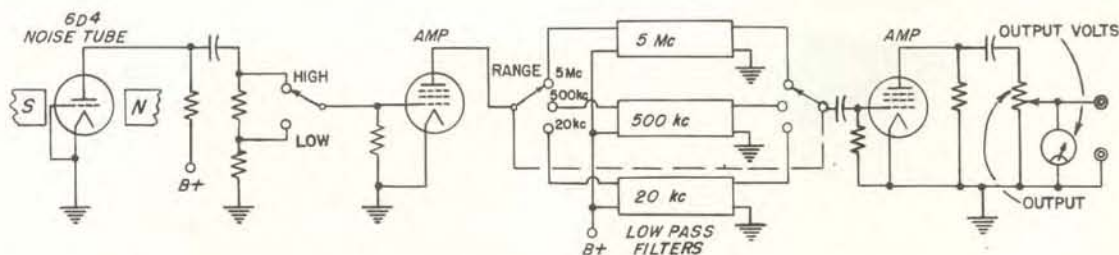

Elementary schematic circuit diagram of the TYPE 1390-A Random-Noise Generator.

Controls: Frequency range switch, power switch, output potentiometer, and a 10:1 level attenuator.

Terminals: Jack-top binding posts with standard 3/4-inch spacing. The lower terminal is grounded to the panel.

Accessories Supplied: TYPE CAP-35 Power Cord and spare fuses.

Accessories Recommended: TYPE 1390-P1 Voltage Divider (see below).

Mounting: Metal cabinet.

Power Supply: 105 to 125 (or 210 to 250) volts, 50 to 60 cycles. Total power consumption is 50 watts.

Instrument will operate satisfactorily on power-supply frequencies up to 400 cycles.

Power input receptacle will accept either 2-wire (TYPE CAP-35) or 3-wire (TYPE CAP-15) power cord. Two-wire cord is supplied. For 3-wire, see page 237.

Tube Complement: One 6D4, one 3-4 amperite, two 6AQ5's.

Dimensions: (Width) 12 × (height) 7 1/2 × (depth) 9 1/4 inches, over-all.

Net Weight: 15 pounds.

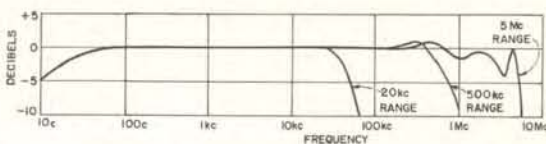

Typical Spectrum Level Characteristics for Type 1390-A Random-Noise Generator.

Type	Code Word	Price
1390-A Random-Noise Generator.....	BUGLE	\$240.00

TYPE 1390-P1 VOLTAGE DIVIDER



The TYPE 1390-P1 Voltage Divider extends the readable range of the output voltmeter-potentiometer combination of the TYPE 1390-A Random Noise Generator down to 20 microvolts. The voltage divider consists of a ladder-type resistive network, mounted in a metal container, which is connected to the generator output by means of a shielded plug and cable. Multiplying factors of 0.1, 0.01, 0.001 and 0.0001 can be selected.

Measurements on high-gain, wideband systems are possible because the frequency characteristic of the divider is flat within 10% for all settings at frequencies up to 5 megacycles.

SPECIFICATIONS

Accuracy: ±3% at low-frequencies.
Impedance: Input 2000 ohms, output 200 ohms.

Dimensions: (Height) 4 1/2 × (diameter) 4 1/2 inches.
Net Weight: 1 1/2 pounds.

Type	Code Word	Price
1390-P1 Voltage Divider	OTTER	\$55.00

METERS



Described in this section are general-purpose meters of several types, including (1) a vacuum-tube voltmeter for the measurement of alternating voltage over wide ranges of frequency and direct voltage of either polarity in applications where negligible current can be taken from the source; (2) oxide-rectifier meters for measuring input voltage and output power, principally at audio frequencies; (3) a megohmmeter for the measurement of high resistances up to 2 million megohms; and (4) an electrometer to measure millivolts, micromicroamperes and megamegohms. All of these represent pioneer work of the General Radio Company.

VOLTMETERS

The first instrument combining a diode peak rectifier with a degeneratively stabilized dc amplifier to indicate the rectified voltage was introduced in 1937. Advantages of this arrangement are wide frequency range, high inherent stability, a convenient circuit for obtaining a multi-range meter, and a calibration substantially independent of tube characteristics. Voltmeters of this type are now used in every conceivable type of application. This circuit is the basis of the highly precise TYPE 1800-B Vacuum-Tube Voltmeter, which covers frequencies from 10 cycles per second to 600 megacycles per second, a span of 6×10^7 . For higher frequencies, a coaxial, rectifier-type instrument is available, the TYPE 874-VR, -VI. Very low voltages (down to 0.5 μv) at audio frequencies can be measured by comparison with the TYPE 546-C Microvolter.

In the General Radio Standardizing Laboratory,

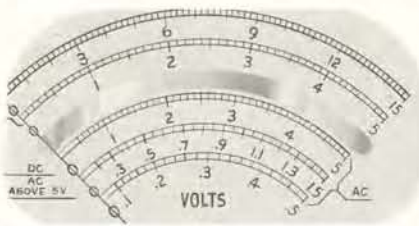

Meter scale of the TYPE 1800-B Vacuum-Tube Voltmeter.

Type	Name	Quantity Measured	Range	Nominal Accuracy	Power Supply	See Page
1800-B	Vacuum-Tube Voltmeter	Volts, A-C or D-C	0.1-150v*	$\pm 2\%$	A-C Line	128
1230-A	Electrometer	Volts Current Resistance	0.5 mv-10v 5×10^{-15} - 10^{-3} a 3×10^5 - $5 \times 10^{14}\Omega$	2% - 4% 3% - 10% 3% - 8%	A-C Line	130
874-VR 874-VI	Crystal Voltmeter	A-C Volts	0.1-2v	$\pm 3\%$	A-C Line for Calibration	50
1862-B	Megohmmeter	Resistance	0.5-2,000,000 M Ω	$\pm 3\%$	A-C Line	132
583-A	Output Power Meter	Power Impedance	0.1 mw-5 w 2.5-20,000 Ω	± 0.5 db $\pm 7\%$	None	134
783-A	Output Power Meter	Power Impedance	0.2 mw-100 w 2.5-20,000 Ω	± 0.25 db $\pm 2\%$	None	134
546-C	Microvolter	Voltage	0.5 μv -1 v	$\pm 3\%$	Audio Oscillator	133

*Multipliers are available to extend range to 1500 volts.

each voltmeter is calibrated by means of a highly precise potentiometer against a standard cell certified by the National Bureau of Standards. Precise ac calibration voltages are obtained by comparison with the dc standard cell. Meters are individually aged and are checked for accuracy and drift over a sufficiently long period of time to assure that they will remain well within specified accuracy.

MEGOHMMETER

The first megohmmeter was introduced in 1936 and applied the degenerative vacuum-tube dc voltmeter to the conventional ohmmeter circuit. The degenerative circuit not only gives stability and linearity, but permits a large voltage swing to take place in the grid circuit of the tube and greatly increases the effective input resistance resulting from grid current. The TYPE 1862-B Megohmmeter, using this circuit, measures insulation resistance with test potentials of either 500 volts or 50 volts applied to the sample.

POWER METERS

General Radio Company also pioneered in the application of oxide-rectifier meters. The first constant-resistance output-power meter of this kind was introduced in 1929 and was followed by the TYPE 583-A Output Power Meter which combines the oxide-rectifier meter with a resistive load and a tapped transformer, providing a sensitive audio-frequency power meter for load resistances varying over a range of 8000 to 1.

A larger model, the TYPE 783-A, measures power up to 100 watts.

ELECTROMETER

The TYPE 1230-A D-C Amplifier and Electrometer is basically a millivoltmeter with an extremely high input resistance. It can also be used conveniently for the measurement of very low currents (5×10^{-15} ampere); high resistances (5×10^{14} ohms); and as a d-c amplifier for very low voltages. A recorder can be operated from the output.



TYPE 1800-B VACUUM-TUBE VOLTMETER



The General Radio TYPE 1800 Vacuum-Tube Voltmeter has gained widespread acceptance as the most accurate peak-responding meter available.

It combines the accuracy of a laboratory instrument with the necessary durability for everyday laboratory and production line use. It measures alternating voltage at frequencies up to several hundred megacycles, as well as dc voltages of either polarity.

Competent circuit design, the best available components, and a mechanical design that emphasizes convenience in use combine to produce the features listed below.

DESCRIPTION: The high-frequency probe contains an acorn-type diode rectifier connected by very short leads to the small, button-type input capacitor mounted on a low-loss insulating disc. Except for the small area of this in-

sulation at the front, the probe is completely shielded. Various fittings and terminations can be attached to the metal probe cap. The cable, which also supplies heater power to the diode in the probe, carries the rectified voltage to a dc amplifier and indicating meter in the cabinet.

The dc amplifier uses a balanced twin triode in a highly degenerative circuit. The rectified alternating voltage is applied directly to the control grid of one triode, and a diode, which balances the effect of the initial-velocity current in the rectifying diode, is connected to the control grid of the second triode. The indicating meter is connected in series with precision range-changing resistors between the cathodes of the amplifying twin triodes.

FEATURES:

- High accuracy, $\pm 2\%$.
- Wide frequency range; full range is covered *without disassembly of probe* and without addition of external capacitor.
- Excellent low-frequency response.
- Probe is shielded against strong rf fields.
- Probe cap can be bolted to ground plane to eliminate high-frequency errors resulting from inductance in ground connection.
- Single zero adjustment holds for all ranges.
- Coaxial fitting and 50-ohm coaxial resistor are supplied for use on probe.
- Calibration is stable and is substantially independent of tube characteristics.
- Regulated power supply eliminates fluctuation in meter indication and zero setting over wide range of line voltages.
- High input impedance.
- Illuminated mirror-type scale.
- Handle detents into position to support panel at angle for easy reading.
- Polarity switch for dc measurements.
- Wire-wound resistors are used in all positions that influence calibration stability.
- Only three controls to handle all functions.
- Fuses accessible from panel.

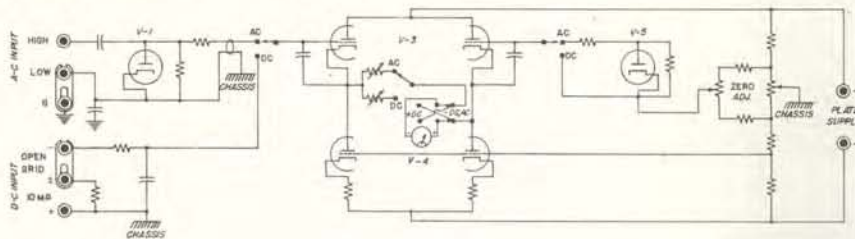

Elementary schematic circuit diagram for the TYPE 1800-B Vacuum-Tube Voltmeter.





SPECIFICATIONS

Voltage Range: 0.1 to 150 volts, ac, in six ranges (0.5, 1.5, 5, 15, 50, and 150 volts, full scale); 0.01 to 150 volts, dc, in six ranges (0.5, 1.5, 5, 15, 50, and 150 volts, full scale).

Accuracy: DC, $\pm 2\%$ of full scale; AC, $\pm 2\%$ of full scale for sinusoidal voltages, subject to frequency correction (see curve). The total warm-up decrease in sensitivity is about 1% of the indicated value on the 1.5-volt range and 3 to 4% of the indicated value on the 0.5-volt range. About one-half of this drift occurs in the first hour. The calibration is set to be correct after complete warm-up.

Waveform Error: On the higher a-c voltage ranges, the instrument operates as a peak voltmeter, calibrated to read r-m-s values of a sine wave, or 0.707 of the peak value of a complex wave. On distorted waveforms the percentage deviation of the reading from the r-m-s value may be as large as the percentage of harmonics present. On the lowest range the instrument approaches r-m-s operation.

Frequency Error: At high frequencies, resonance in the input circuit and transit-time effects in the diode rectifier introduce errors in the meter reading. The resonance effect causes the meter to read high and is independent of the applied voltage. The transit-time error is a function of the applied voltage and causes the meter to read low. The accompanying curves show the frequency range for 1-db resultant error. The resonant frequency with cap on but plug removed is about 1050 Mc. Correction curves are supplied.

At the indicated frequency of 15 cycles, the meter indication begins to fluctuate as it tends to follow the voltage change within each cycle.

Input Impedance: See plot; the equivalent parallel capacitance at radio frequencies is 3.1 μf with the probe cap and

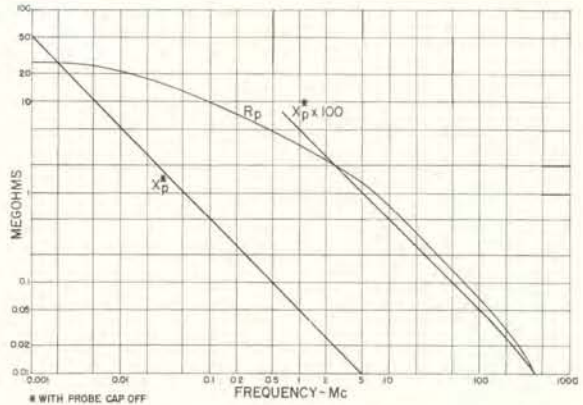

Plot of components of input impedance as a function of frequency.

plug removed. The probe cap and plug add approximately 1.2 μf .

On the dc ranges two values of input resistance are provided, 10 megohms and open grid.

Power Supply: 105 to 125 or (210 to 250) volts, ac, 50 to 60 cycles. The instrument incorporates a voltage regulator to compensate for supply variations over this voltage range. The power input is less than 25 watts.

Instrument will operate satisfactorily on power-supply frequencies up to 400 cycles.

Power input receptacle will accept either 2-wire (TYPE CAP-35) or 3-wire (TYPE CAP-15) power cord. Two-wire cord is supplied. For 3-wire, see page 237.

Tube Complement:

2-9005	1-6SL7-GT	1-3-4
1-6SU7-GTY	1-6AT6	2-991
1-6C4	1-6X5-GT	

Accessories Supplied: TYPE CAP-35 Power Cord, spare fuses, TYPE 274 and TYPE 874 terminations, and 50-ohm coaxial terminating resistor for probe.

Mounting: Crackle finish aluminum panel mounted in a shielded hardwood cabinet. The cable and probe are stored in the cabinet.

Dimensions: (Width) 7 $\frac{3}{8}$ \times (depth) 7 $\frac{1}{2}$ \times (height) 11 $\frac{1}{8}$ inches, over-all. **Net Weight:** 13 $\frac{3}{4}$ pounds.

Frequency characteristics—data taken with complete probe, cap on, but banana plug removed.

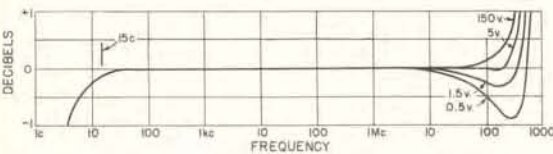

<i>Type</i>	<i>Code Word</i>	<i>Price</i>
1800-B	Vacuum-Tube Voltmeter	DUCAT \$435.00



TYPE 1800-P2 HIGH-FREQUENCY MULTIPLIER
For AC Use Above 100 kc

Multiplication Ratio: 10:1 $\pm 5\%$; can be adjusted to $\pm 1\%$ on voltmeter.

Input Impedance: Resistance 100 times that of voltmeter; capacitance, 2 μf with probe cap off, 1.5 μf with cap on.

Dimensions: (Dia.) 1 $\frac{3}{8}$ \times 2 inches.

<i>Type</i>	<i>Code Word</i>	<i>Price</i>
1800-P2	Multiplier	ARODE \$23.00



TYPE 1800-P3 LOW-FREQUENCY MULTIPLIER
For DC and AC Use up to 100 kc

Multiplication Ratio: DC, 10:1 $\pm 1.5\%$; AC, 10:1 $\pm 5\%$; can be adjusted to match voltmeters at any frequency or for less than 3% error, 20 c to 20 kc, less than 5% up to 100 kc.

Input Impedance: 10 megohms shunted by 10 μf .

Dimensions: 5 \times 2 \times 2 inches.

Net Weight: 8 ounces.

<i>Type</i>	<i>Code Word</i>	<i>Price</i>
1800-P3	Multiplier	ABHOR \$35.00

TYPE 1230-A D-C AMPLIFIER AND ELECTROMETER



USES: The D-C Amplifier and Electrometer is basically a millivoltmeter with extremely high input resistance. It measures:

- Voltage—0.5 millivolt to 10 volts.
 - Current— 5×10^{-16} to 10^{-3} amperes.
 - Resistance— 3×10^5 to 5×10^{14} ohms.
- These quantities are indicated on a panel meter, and output is available to operate recorders and other equipment.

Because of its high sensitivity and excellent stability, this instrument has a wide range of applications in science, engineering, and industry. Typical examples include the measurement of:

- Ionization currents, photo currents, grid currents in electron tubes, and time-current curves of capacitors during charge and discharge.
- Piezo-electric potentials, bioelectric potentials, contact potentials, electrostatic field potentials, and pH indications.
- Back resistance of silicon-junction diodes, interconductor resistance of cables, insulation resistance of electrical equipment, and voltage coefficient of resistance.

- It amplifies weak dc and low-frequency voltages to operate recorders and other equipment.

DESCRIPTION AND FEATURES: The *circuit* is a three-stage direct-coupled amplifier that acts as a highly degenerated cathode follower and has high overall transconductance. Excellent linearity is obtained even on the lowest scales.

- *Voltage* is measured directly; *current* is measured in terms of the voltage drop across a standard resistor, through which the current flows; and *resistance* in terms of a standard voltage source connected in series with the standard and unknown resistors.

- To achieve *maximum stability*, power-supply voltages are stabilized; components are carefully chosen and well aged; chassis and sub-assemblies are shock mounted.

- *High input resistance*, even under conditions of high humidity is achieved by use of an electrometer tube and by enclosure of the input grid lead in silicone-treated glass. Input resistance selector has switch contacts that are mounted on individual teflon bushings set in a metal base that connects to a guard point.

- *Input stage is completely shielded*, and the coaxial input terminal permits this shielding to be extended to the unit under test. A fully shielded chamber, the TYPE 1230-P1 Component Shield, is available as an accessory, within which components to be measured can be quickly and easily connected.

- *Guard terminals are provided*. The low input terminal can be grounded or not, as desired.

- The output meter has two voltage scales and two resistance scales, which provide two ranges per decade.

- Terminals are provided for connecting an external meter or recorder. The Esterline-Angus (or equivalent) 5-ma Graphic Recorder is recommended and TYPE 1230-AE D-C Amplifier and Electrometer is installed in an Esterline-Angus case to match the recorder. More sensitive recorders can be shunted for 5-ma operation.

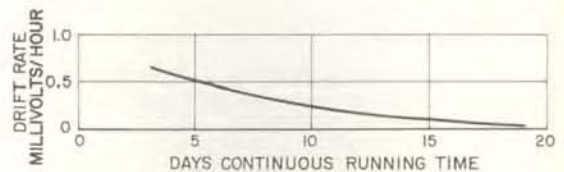

Typical drift after tubes are changed.



TYPE 1230-P1 Component Shield (with shield cover removed) plugged into the input terminal at the rear of the electrometer.



TYPE 1230-AE D-C Amplifier and Electrometer with a recorder.

SPECIFICATIONS

Voltage Ranges: ±30, 100 and 300 millivolts; ±1, 3 and 10 volts; dc, full-scale. Accuracy is ±2% of full scale on the five highest ranges; ±4% of full scale on the 30-mv range.

Current Ranges: ±1 milliamperes dc (10⁻³ amp.) full scale to ±300 milli-microamperes (3 × 10⁻¹³ amp.) full scale, in twenty ranges (two per decade). Accuracy is ±3% of full scale from 10⁻³ amp to 10⁻⁹ amp; ±10% of full scale from 3 × 10⁻¹⁰ amp to 3 × 10⁻¹³ amp.

Effective Transconductance: 33 mhos.

Frequency Characteristic: With a 1500-ohm load at the OUTPUT terminals, the frequency characteristic is flat within 5% from zero to 10, 30, 100, 300, 1000 and 3000 cycles at the 30-, 100-, 300-millivolt, 1-, 3-, and 10-volt ranges, respectively.

Resistance Ranges: Direct reading in resistance from 300 kilohms to 10 mega-megohms (10¹³ ohms) at full scale (5 × 10¹⁴ ohms at smallest meter division). There are sixteen ranges (two per decade). At full scale (low-resistance end) accuracy is ±3% from 3 × 10³ ohms to 10¹⁰ ohms; ±8% from 3 × 10⁹ ohms to 10¹² ohms. The voltage across the unknown resistance is 9.1 volts.

External DC Supply: By the use of external batteries, or other suitable external supply, the resistance range can be extended, the voltage across the unknown can be increased, and the voltage coefficient of resistors can be measured.

With a 300-volt battery, the highest resistance range is 10¹⁵ ohms full scale (6 × 10¹⁶ ohms at the smallest meter division). The full battery voltage appears across the unknown resistance. The maximum permissible voltage is 600 volts if the external supply is grounded; somewhat greater if ungrounded.

Resistance Standards: 10⁴, 10⁵, 10⁶, 10⁷, 10⁸, 10⁹, 10¹⁰, and 10¹¹ ohms. The switch also includes "zero" and "infinity" positions. The 10⁴- and 10⁵-ohms resistors are wire wound and are accurate to ±0.25%. The 10⁶-, 10⁷-, and 10⁸-ohm resistors are of deposited-carbon construction and are accurate to ±1%. The 10⁹, 10¹⁰ and 10¹¹ resistors are carbon, have been treated to prevent adverse humidity effects, and are accurate to ±5%. A switch position permits quick checking of

the higher-resistance standards in terms of the wire-wound units.

Input Resistance: The input resistance is determined by the setting of the resistance standards switch. In the infinity position, it is approximately 10¹⁴ ohms.

Drift: Less than 2 mv per hour after one-hour warmup.

Output: Voltage, current and resistance are indicated on a panel meter. Terminals are available for connecting a recorder (such as the Esterline-Angus 5-ma or 1-ma graphic recorder). The recorder can have a resistance of up to 1500 ohms.

Input Capacitance: Less than 35 μf.

Terminals: The input is connected through an 874-type coaxial terminal assembly at the rear of the instrument. In addition, there are three "low" terminals to provide versatility in guard and ground connections, as required, for example, in three-terminal network measurements.

Input Switch: A panel switch permits disconnection of the unknown without transient electrical disturbances in either the unknown or the measuring circuit.

Input Insulation: Entirely teflon or silicone-treated glass.

Temperature, Humidity, Line Voltage Effects: Negligible.

Tube Complement: One 5886 electrometer, one CK6418, one 6AN5, one 6AL5, one 6E27, and three 0B2.

Accessories Supplied: One TYPE 874-411 Adaptor, one TYPE 1230-P1-300 Panel Adaptor Assembly, two TYPE 274-MB Plugs, one TYPE 274-SB Plug, spare fuses and TYPE CAP-35 Power Cord.

Accessories Available: TYPE 1230-P1 Component Shield. **Mounting:** Aluminum front and rear panels finished in crackle lacquer and encased in an aluminum wrinkle-finished sleeve-like cabinet. The instrument is also available mounted inside a recorder case.

Power Supply: 105 to 125 (or 210 to 250) volts, 50 to 60 cycles. Power input is approximately 45 watts at 115 volts. Instrument will operate satisfactorily on power-supply frequencies up to 400 cycles. Power input receptacle will accept either 2-wire (TYPE CAP-35) or 3-wire (TYPE CAP-15) power cord. Two-wire cord is supplied. For 3-wire, see page 237.

Dimensions: (height) 13¼ × (width) 7¾ × (depth) 9 inches, over-all.

Net Weight: 15¼ lbs.

Type		Code Word	Price
1230-A	D-C Amplifier and Electrometer.....	MASON	\$440.00
1230-AE	D-C Amplifier and Electrometer in Esterline-Angus Case	MISTY	502.00
1230-P1	Component Shield	MANOR	40.00

PATENT NOTICE. See Note 4, page x.





TYPE 1862-B MEGOHMMETER



USES: Rugged, versatile, and safe, this megohmmeter rapidly measures wide ranges of resistance at either of two test voltages. The 50-volt level is useful in resistance measure-

ments on printed circuits, transistor circuit components, and miniaturized circuit components. The 500-volt level is a standard value in the measurement of the insulation resistance of rotating machinery, transformers, cables, capacitors, appliances, and other electrical equipment.

Stabilized power supply and time constant permit rapid and accurate measurement of the leakage resistance of capacitors.

Guard and ground terminals permit measurement of the grounded and ungrounded sections of three-terminal resistors.

DESCRIPTION: The megohmmeter consists of a stabilized power supply, a complement of resistance standards, and an indicating meter. The indicator is a balanced, dc vacuum-tube voltmeter that has two volts full-scale sensitivity and a very high input resistance.

FEATURES:

- Direct-reading and simple to operate.
- Test voltages of 50 and 500 permit approximate measurement of voltage coefficient.
- Voltage can be removed from unknown terminals by setting switch to CHECK or DISCHARGE positions, thus permitting connections to be made without danger of shock.
- Guard and ground terminals provided.

SPECIFICATIONS

Range: 0.5 megohm to 2,000,000 megohms at 500 volts and to 200,000 megohms at 50 volts. There are six decade steps as selected by a multiplier switch.

Scale: Each resistance scale up to 500,000 megohms utilizes 90% of the meter scale. Center-scale values are 1, 10, 100, 1000, 10,000 and 100,000 megohms.

Accuracy: From $\pm 3\%$ at the low-resistance end of each decade, to $\pm 12\%$ at the high-resistance end up to 50,000 megohms. There can be an additional $\pm 2\%$ error at the top decade. For 50 volt operation, there is an additional $\pm 2\%$ error on all but the 0.5 to 5 megohms decade where the additional error can be $\pm 5\%$.

Voltage On Unknown: 50 to 500 volts, as selected by switch on front panel, indicator lamp is lighted when 500 volts are applied. At resistance values below 0.5 megohm, the applied voltage drops to limit the current to safe values. Voltage across unknown is 500 volts within ± 10 volts, or it is 50 volts within ± 4 volts. This voltage source is stabilized for operation from 105-125 volt lines (or 210-250 volt line).

Terminals: Unknown, ground and guard terminals. At two positions of a panel switch, all voltage is removed from all terminals to permit connection of the unknown in safety. In one of the positions, the UNKNOWN terminals are shunted to discharge the capacitive component of the unknown. All but the ground terminals are insulated.

Calibration: Standardizing means provided.

Tube Complement: One each, 12AU7, 0A2, 6X4, 2X2-A, 6AB4, 6AU6, 5651.

Mounting: Crackle-finished aluminum panel and cabinet with carrying handles and phenolic protective sides.

Power Supply: 105 to 125 (or 210 to 250) volts, 40-60 cycles, 25 watts.

Accessories Supplied: Spare fuses; two color-coded test leads.

Dimensions: 10 $\frac{1}{8}$ (height) \times 9 $\frac{1}{8}$ (width) \times 11 $\frac{3}{4}$ (depth) inches, over-all.

Net Weight: 15 $\frac{1}{2}$ pounds.

Type	Code Word	Price
1862-B Megohmmeter	JUROR	\$255.00

MEGOHM BRIDGE: The TYPE 544-B Megohm Bridge, a bridge-type instrument for resistance measurements in the megohm range, is described on Page 8.

ELECTROMETER: The TYPE 1230-A D-C Amplifier and Electrometer, described on page 130 measures resistances as high as 5×10^{14} ohms, as well as very low voltages and currents.





TYPE 546-C AUDIO-FREQUENCY MICROVOLTER

USES: The TYPE 546-C Audio-Frequency Microvolter used in conjunction with an oscillator is a useful source of small, known, audio-frequency voltages. In measuring the response of amplifiers, transformers, and other audio equipment, such a source of known input voltage is extremely valuable. The microvolter can also be used to measure other small voltages by substitution methods.

DESCRIPTION: This instrument consists, essentially, of a constant-impedance attenuator and a voltmeter by means of which the input to the attenuator is standardized. A switch controls the output voltage in decade steps, while an individually calibrated dial provides continuous control over each decade.

FEATURES:

- An excellent frequency characteristic, extending from very low frequencies up to 100,000 cycles.
- Excellent accuracy is obtainable for absolute voltage levels as well as for voltage ratios



- in gain or loss measurements.
- Decibel scales, in addition to the voltage calibration of the meter and multipliers, simplifies the measurement of response characteristics in decibels.

SPECIFICATIONS

Output Voltage Range: From 0.5 microvolt to 1.0 volt open circuit, when the input voltage is set to the standardized reference value.

Accuracy: For open-circuit output voltages the calibration is accurate within $\pm(3\% + 0.5 \text{ microvolt})$ for output settings above 1 microvolt and for all frequencies between 20 and 20,000 cycles. For higher frequencies up to 100 kc the calibration is accurate within $\pm 5\%$ for output settings above 100 microvolts. These specifications apply only where waveform and temperature errors are negligible (see below).

In calculating ratios of output voltages, at a given frequency, the accuracy of any given reading can be considered to be within $\pm(2\% + 0.5 \text{ microvolt})$, at frequencies up to 100,000 cycles. At frequencies above 20 kc this accuracy applies only at levels above 100 microvolts.

The microvolter can be used on dc with an external d-c meter. Internal meter can be calibrated for dc. **Output Impedance:** The output impedance is approximately 600 ohms, constant with setting within $\pm 5\%$. No correction on the output voltage is necessary for load impedances of the order of 100,000 ohms and greater.

Input Impedance: Approximately 600 ohms, substantially independent of output setting on all but the highest multiplier position.

Waveform Error: The accuracy of the microvolter as a calibrated attenuator or voltage divider is independent of waveform. The absolute accuracy of the output voltage calibration depends on the characteristics of the input copper-oxide rectifier voltmeter, which has a small waveform error that depends in turn on both the phase and the magnitude of harmonics present in the input. This error in the voltmeter can, in general, be neglected when the microvolter is used with ordinary laboratory oscillators. The rectifier-type voltmeter itself introduces some distortion unless the source impedance is very low. With a 600-ohm source the distortion introduced is about 0.2%.

Temperature Error: The accuracy of the calibration is independent of temperature when the microvolter is used as an attenuator or voltage divider. The absolute accuracy is affected slightly by temperature because of change in the voltmeter characteristics. The necessary correction for temperatures from 65° to 95° Fahrenheit is furnished with the instrument. The effects of humidity are negligible.

Power Source: The driving oscillator must be capable of furnishing about 2.2 volts across 600 ohms.

Terminals: Jack-top binding posts are mounted on standard 3/4-inch spacing.

Mounting: The instrument is mounted on an aluminum panel in an aluminum cabinet.

Dimensions: (Length) 10 x (width) 7 1/8 x (height) 6 1/8 inches, over-all.

Net Weight: 6 1/2 pounds.

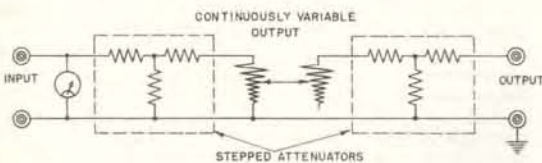

Type	Code Word	Price
546-C Audio-Frequency Microvolter*	CROWN	\$140.00

*Reg. U. S. Pat. Off.





OUTPUT POWER METERS



USES: The output power meters indicate directly the audio-frequency power that a source delivers into any desired load. They are widely used to determine the output characteristics and internal impedance of lines, oscillators, amplifiers, transformers, transducers, and other networks. Two models are offered with maximum readings of 5 watts and 100 watts respectively.

DESCRIPTION: Functionally, the system is an adjustable load across which is connected a voltmeter reading directly in watts dissipated in the load. An auxiliary db scale is provided.

FEATURES:

- Direct-reading in power and impedance.
- Auxiliary decibel scale.
- Wide ranges.



SPECIFICATIONS

TYPE 783-A

Power Range: 0.2 milliwatt to 100 watts in five decade ranges. An auxiliary decibel scale with multiplier reads from -10 to +50 decibels above 1 milliwatt.

Impedance Range: 2.5 to 20,000 ohms. Forty discrete impedances, distributed approximately logarithmically.

Impedance Accuracy: Within $\pm 2\%$ of the indicated value, except at the higher frequencies for high-impedance settings. At 15,000 cycles the input impedance error is about 5% for impedances from 10,000 to 20,000 ohms.

Power Accuracy: The indicated power is accurate to ± 0.25 db at full-scale reading. At the lowest impedance multiplier setting (2.5 to 20 ohms) there may be an additional error of 0.2 db due to switch contact resistance when the highest power range is used.

The over-all frequency characteristic of the power indication is flat within ± 0.5 db from 20 cycles to 10,000 cycles; within ± 0.75 db to 15,000 cycles.

Waveform Error: Calibrated in rms values for a sinusoidal applied voltage. When nonsinusoidal voltages are applied, the error will depend on the magnitude and phase of the harmonics present.

Mounting: The instrument is mounted on an aluminum panel in a hardwood cabinet.

Dimensions: 8 x 18 x 7 inches, over-all.

Net Weight: 17 pounds.

TYPE 583-A

Power Range: 0.1 to 5000 milliwatts in four decade ranges. An auxiliary scale with multiplier reads from -10 to +37 decibels above 1 milliwatt.

Impedance Range: 2.5 to 20,000 ohms. Forty discrete impedances, distributed approximately logarithmically, are obtained.

Accuracy: The maximum error in full-scale power reading does not exceed 0.5 decibel between 150 and 2500 cycles, nor does it exceed 1.5 decibels at 20 and 10,000 cycles. The average error is 0.3 decibel at 30 and 5000 cycles, and 0.6 decibel at 20 and 10,000 cycles.

The maximum error in impedance does not exceed 7% between 150 and 3000 cycles, nor does it exceed 50% at 20 and 10,000 cycles. The average error is 8% at 30 and 5000 cycles and 20% at 20 and 10,000 cycles.

Waveform Error: Calibrated in rms values for a sinusoidal applied voltage. When nonsinusoidal voltages are applied, the error will depend on the magnitude and phase of the harmonics present.

Mounting: The instrument is mounted on an aluminum panel in a hardwood cabinet.

Dimensions: (Length) 10 x (width) 7 x (height) 6 inches, over-all.

Net Weight: 8 1/4 pounds.

Type		Code Word	Price
583-A	Output-Power Meter	ABUSE	\$165.00
783-A	Output-Power Meter	ABBAY	370.00



RADIO STATION MONITORS



The General Radio Company pioneered in the development of measuring instruments for broadcasting stations, having supplied specialized frequency measuring equipment as early as 1924, and modulation measuring apparatus since 1931. Later, when the Federal Communications Commission required continuous monitoring, General Radio instruments were developed to satisfy these conditions.

The soundness of these early designs was attested by their wide acceptance and long, trouble-free operation. Each succeeding model profited by the field experience of its predecessor, and early obsolescence was never permitted to occur. Many of the extra features built into General Radio monitoring equipment assure long life in a rapidly changing industry. Approved monitoring equipment currently listed by the FCC still show General Radio equipment designed and placed in use more than 15 years ago, whose manufacture has been discontinued for more than a decade.

The General Radio Company alone has a continuous record of design and manufacture of this class of equipment, and this fact is widely recognized in the field of broadcasting. By a huge majority, radio and TV stations throughout the United States are GR equipped.

Current models are designed for the utmost in convenience and accessibility (see page 141). Practically all adjustments and servicing operation can be performed without removal of the monitor from the rack, and without reference to an instruction book.

Remote Monitoring: Unattended transmitter operation usually requires that the monitoring equipment be adaptable to remote control operation. General Radio monitoring instruments have historically included such features as provision for external meter connections and as high an r-f input sensitivity as is consistent with reliable performance. The existence of these features in both old and new equipment assures adaptability to remote service.

Frequency Monitors: The function of the frequency monitor is to indicate the deviation of the transmitter frequency from its assigned channel. Fundamentally, it

consists of a frequency standard and a means of indicating the difference between the transmitter frequency and that of the standard. For convenience in measuring the difference frequency, the frequency of the standard is usually offset from that of the assigned channel. The deviation indicator is calibrated directly in cycles (or kilocycles) off the assigned channel frequency.

Modulation Monitor: Percentage modulation for A-M transmitters is measured by a system in which the modulated signal from the transmitter is rectified in a linear diode rectifier to produce an a-c voltage proportional to the instantaneous value of the carrier envelope and a d-c voltage proportional to the average carrier amplitude. The ratio of these voltages is continuously indicated by a voltmeter calibrated in modulation percentage. A flashing lamp indicates modulation peaks in excess of any pre-set level.

Standard Broadcast Band: For the standard broadcast frequencies, 540 to 1550 kilocycles, the TYPE 1181-B Frequency Deviation Monitor (page 138) and the TYPE 1931-B Modulation Monitor (page 140) are used. These instruments are fully described on the pages indicated.

Television: The new TYPE 1184-A-A Television Transmitter Monitor has been designed for use with both monochrome and color transmitters. It provides continuous indications of aural modulation and the frequency of both aural and visual transmitters, or a direct monitoring of the intercarrier frequency. Outputs are available for operation of a monitoring speaker, and for the measurement of the aural (f-m) transmitter fidelity characteristics, distortion, noise level, residual a-m noise on the aural transmitter, and residual f-m noise on the visual transmitter.

The Color Subcarrier Monitor (page 138) monitors the color subcarrier frequency 3.579545 Mc to assure that it stays within the 10-cycle tolerance.

Type	Monitor	Page
1181-B-BH	Frequency Deviation Monitors	138
1181-BT	Color Sub-carrier Monitor	138
1184-A-A	Television Transmitter Monitor	136
1931-B	Modulation Monitor	140

▶ OTHER BROADCASTING STATION MEASUREMENTS ◀

FREQUENCY MEASUREMENTS

The TYPE 1213-C Time/Frequency Calibrator (page 86) provides an accurate and convenient means for checking the frequencies of transmitters and monitors against the standard-frequency transmissions of WWV and WWVH. The procedure is covered in a paper by Cady and Buuck entitled "Frequency Measurements in the Broadcast Field." Write for a copy.

TV Transmitter Harmonics: These measurements, now required by FCC Regulations, can be made with standard General Radio coaxial measuring equipment. See TYPE 874-FR Rejection Filters, page 49.

Tube Life Greatly Extended by Automatic Line-Voltage Regulator: Experience of broadcasters indicates that use of the TYPE 1570 Regulator on the transmitter filament supply quickly saves its cost by greatly extending tube life. See page 218 for description of this regulator.

Distortion: The FCC Standards of Good Engineering Practice specify maximum permissible percentage of distortion for various broadcast services. The TYPE

1932-A Distortion and Noise Meter (page 225) and the TYPE 1301-A Low Distortion Oscillator (page 101) are designed to measure transmitter distortion, as well as carrier noise, rapidly and accurately. The Distortion and Noise Meter operates from the output of the TYPE 1931-B Modulation Monitor, the TYPE 1184-A-A TV Transmitter Monitor, or the TYPE 1170-B F-M Monitor.

Antennas, Lines, etc.: The General Radio Company manufactures an extensive line of bridges and other impedance-measuring equipment suitable for determining the impedance of antennas, lines, and phasing and matching networks. For various frequency bands, the following instruments are recommended:

Type	Page
50 kc-5 Mc	916-AL R-F Bridge 32
400 kc-60 Mc	1606-A R-F Bridge 30
10-165 Mc	1601-A V-H-F Bridge 33
50-1500 Mc	1602-B Admittance Meter 34
300-3000 Mc	874-LBA Slotted Line 43



TYPE 1184-A-A TELEVISION TRANSMITTER MONITOR

FCC Approval No. 3-105



USES: The Television Transmitter Monitor provides, in one complete unit, all the functions necessary to meet the requirements of the Federal Communications Commission for monitoring television transmitters, plus other functions that make it possible for the station operating staff to check either continuously or periodically several key factors that indicate the operating condition of the transmitter. This instrument will:

- Indicate continuously the carrier frequency deviations from nominal channel frequencies of both the aural and the visual transmitters.
- Indicate continuously the difference, or intercarrier, frequency.
- Indicate continuously the frequency-modulation deviation of the aural transmitter.
- Indicate by a light flashing, when the deviation exceeds a preset value.
- Provide an audible monitor of intercarrier FM to warn instantly of loss of either carrier or of overmodulation of the visual carrier.

In addition, the following measurements can be made:

- Audio fidelity (distortion, noise, and frequency response) measurements on the aural transmitter, as required by FCC proof-of-performance regulations.
- Residual a-m noise on both transmitters.
- Residual fm noise on the visual transmitter with full video-modulation applied. (This can be monitored continuously on an external Distortion and Noise Meter, such as the TYPE 1932-A).

- An intercarrier demodulation system is provided in which the sound recovery is identical with that of an intercarrier-type receiver.
- All metering circuits can be connected to external indicators. A 600-ohm aural monitoring output is provided.
- This monitor will operate on any UHF or VHF television channel, with both color and black-and-white transmitters.

DESCRIPTION: The monitor chassis is mounted on slides and pivots that always support its weight. It can be installed, operated, and serviced entirely from the front. It is completely accessible while in operation, without removal from the relay rack. All controls, including circuit-function test switches, are available directly behind an easily removable panel plate which can be supplied in color to match other station equipment. These features are illustrated under TYPE 1181-B Frequency Deviation Monitor, page 138.

Chassis marking is so complete that most maintenance operations can be done without using an instruction book. Key voltages can be checked by a panel meter and a switch, and chassis pin jacks provide for rapid checking at other points.

The monitor operation is shown in the block diagram. A highly stable, precision crystal oscillator is used as a master reference frequency, whose appropriate harmonic is used to produce beats of 150 kc and 4.35 Mc, respectively, with the aural- and visual-transmitter carrier frequencies.

The 4.35 Mc beat frequency operates (1) a visual-carrier frequency-deviation meter and (2) a limiter-discriminator circuit whose output is a measure of the fm noise on the visual transmitter carrier.

The 150-kc beat frequency operates (1) the modulation meter calibrated in percentage frequency-modulation of the aural transmitter, (2) the audio monitoring and fidelity measuring systems, and (3) an aural-carrier frequency-deviation meter.

The three functions noted above can be switched to operate from a separate intercarrier-beat detector, whose output is heterodyned with a secondary-reference oscillator. The performance obtained simulates the sound recovery in an intercarrier-type receiver, and the frequency meter directly indicates deviation of the intercarrier beat frequency from its FCC assigned value of $4.5 \text{ Mc} \pm 1 \text{ Kc}$.



SPECIFICATIONS

Frequency Range: 50-890 Mc (tv channels 2 to 83), RF INPUT

- 1. Impedance: Low-impedance loop coupling.
2. Level: Intended for use with standard EIA transmitter monitoring outputs (10 volts, 50 Ω).
3. Max Sensitivity: One volt Visual, two volts Aural.
4. Adjustments: Input levels for both aural and visual transmitter are adjustable from the front.
5. Indication: Both aural- and visual-transmitter input levels can be checked on a panel meter.

Frequency: Crystal Stability—master reference, ±0.1 ppm/30 days secondary reference, ±5 ppm/30 days (=22.5 cycles).

Accuracy:

Table with 4 columns: Meter Scale, Metering Accuracy, Overall Accuracy, and Inter-Carrier. Rows include Aural and Visual specifications for 3-0-3 kc, 200c, 30c, and 250c.

Image Frequency Check: A checking device is incorporated to insure that the transmitter frequency is on the correct side of zero beat.

Aural Modulation (FM): Meter Scale, 0 to 100% + 3 db, full scale; Meter Ballistics, as required by FCC specifications; Meter Calibration, 100% = 25 kc deviation; selector switch for 100% = 50 kc to permit wide-deviation type-tests; Polarity Response, panel switch for positive or negative peaks, for both meter and flashing lamp; Peak Indicator, flashing lamp indicates peaks in excess of dial setting; Dial, calibrated from 0 to 100% and to +3 db above 100%; Meter Frequency Response, ±0.25 db from 50 to 15,000 cycles, ±0.5 db from 30 to 20,000 cycles; Peak Indicator Frequency Response, 0.5 db from 100 to 15,000 cycles.

FIDELITY MEASUREMENTS

Aural F-M Transmitter: Audio Outputs (at low frequencies with 100% modulation), 10.8 volts into 100 kΩ or 0 dbm into 600 Ω. Residual Distortion (50 to 15,000 cycles), 0.15% for 25 kc modulation deviation, and 0.25% for 50 kc deviation; Residual FM Noise, -70 db below 25 kc modulation deviation; Audio Response, follows 75-μsec de-emphasis curve within ±0.5 db from 50 to 15,000 cycles, ±3 db from 15 to 30 kc; A-M Noise Reference Level (at low frequencies), 4 volts into 100 kΩ; Residual Noise, AM, -70 db below carrier level.

Visual A-M Transmitter: Noise (FM) Measuring Output (at low frequencies and 25 kc deviation), 1.5 volts into 100 kΩ load, 75-μsec de-emphasis circuit included; Residual (FM) Noise, -65 db below 25 kc deviation with normal video modulation on transmitter (-70 db without video modulation).

Inter-carrier Measurements: Same as for aural transmitter, except Residual (FM) Noise is -63 db below

25 kc deviation of aural transmitter with video modulation applied to visual transmitter.

EXTERNAL CONNECTIONS

- 1. Frequency Meters: Visual Transmitter, GR TYPE MEDS-41-3, 0-200 μa dc, 510 Ω, one side grounded. Aural Transmitter, GR TYPE MEDS-72, 100-0-100 μa dc, 510 Ω, one side grounded.
2. (FM) Modulation Meter: GR TYPE MEDS-28, 0-600 μa dc, 680 Ω, neither side grounded.
3. Modulation-Peak Indicator: 3 watt-115 v lamp, one side grounded.
4. Audio Monitoring Output: Unbalanced—600 Ω, 100% modulation = 0 dbm.
5. Audio Measurement Output: Intended for use with the TYPE 1932-A Distortion and Noise Meter (100 kΩ unbalanced input); 10.8 volts output at low frequencies; behind-the-panel test jack for connecting on a temporary basis; rear jack provided for permanent wiring to rack-mounted Distortion and Noise Meter.
6. Power Cables: Standby line, for master crystal oven; power line, for monitor circuits.
Power Supply: 105 to 125 (or 210 to 250) volts, 50 to 60 cycles. Power input receptacle will accept either 2-wire (TYPE CAP-35) or 3-wire (TYPE CAP-15) power cord. Two-wire cord is supplied. For 3-wire, see page 237.
Standby Operation (at 115/230 volts) 15 watts, with master crystal oven operating.
Normal Operation (at 115/230 volts) Max demand 265 watts. (155 watts during 30-second initial warm up).

Mounting: 19-inch rack-panel mounting. Front panel removable for access to controls. All controls available from front. Instrument mounted on slides for access to all parts. Designed for vertical-air-flow cabinet racks. Panel Finish: GR crackle; also available in certain standard colors to match station equipment.

Dimensions: (Width) 19 × (height) 21 × (depth) 16 inches over-all.

Net Weight: 75 lbs.

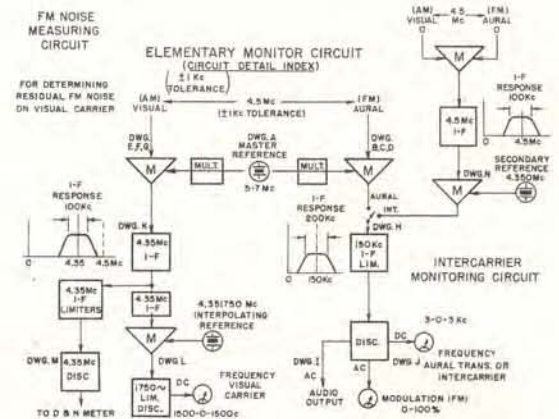

Table with 4 columns: Type, Television Transmitter Monitor Channels, Code Word, and Price. Rows for models 1184-A-A (Channels 2-13) and 1184-A-A (Channels 14-83).

PATENT NOTICE: See Notes 2, 4, and 16, page x.

TYPE 1181-B FREQUENCY DEVIATION MONITOR

FOR AM TRANSMITTERS IN THE STANDARD BROADCAST BAND
FCC Approval No. 3-106



USES: The TYPE 1181-B Frequency Deviation Monitor indicates directly the magnitude and direction of the frequency deviation of a broadcast transmitter from its assigned channel frequency. A monitor of this type is required by the Federal Communications Commission for each station in the standard broadcast band.

The Frequency Deviation Monitor can be used to monitor A-M transmitters from a location remote from the transmitter site, as required in FCC rules permitting unattended operation of transmitters. The low input signal required, (approximately 50 millivolts), permits operation up to several miles from the transmitter with only a single-wire antenna necessary to pick up adequate signal voltage. The antenna may be tuned to provide additional selectivity, if desired. The narrow frequency band of the i-f system in the monitor usually provides adequate noise rejection.

DESCRIPTION: Voltages from a temperature-controlled piezo-electric oscillator (offset 1000 cycles from the assigned channel frequency)

and the transmitter to be monitored are amplified and fed to a mixer from which their difference frequency is obtained. This audio frequency is amplified; its peaks are clipped to produce an essentially square waveform, which is applied to an audio-frequency meter. The indicator is calibrated to read zero when the audio beat is exactly 1000 cycles. Deviations from 1000 cycles are indicated directly as the frequency deviation of the transmitter.

The monitor is a-c operated and is mounted on a single relay-rack panel.

Chassis pulls forward on slides and tilts to give access to all components. All installation tests and maintenance adjustments can be performed from the front of the rack. The inside face of the removable dress panel carries a block diagram and condensed operating instructions. Signal flow lines and test jacks on the chassis make frequent reference to the instruction book unnecessary for either operation or maintenance.

FEATURES:

- Proved by use. Almost every broadcast transmitter in America is equipped with this or previous models of this monitor.
- Simple to install—easy to maintain.
- High reliability for continuous service.
- Suitable for remote monitoring.
- Deviation indication is unaffected by amplitude modulation.
- Deviation indication is independent of r-f input level, over a wide range.
- Very low r-f input power.
- Positive indication of failure of transmitter carrier is provided by signal-level pilot lamps. A push-button test indicates whether or not the monitor crystal voltage is adequate. Other pilot lamps indicate heater-thermostat and power circuit operation.
- External deviation indicator can be connected.

SPECIFICATIONS, TYPE 1181-B

Deviation Range: ± 30 cycles, readable to one cycle.
Carrier Frequency Range: 500 to 1600 kc.
Accuracy: When received, within ± 5 parts per million. An adjustment is provided to bring the reading into agreement with monitoring station measurements.
Stability: Better than one part in a million under normal operating conditions for 6 months after an initial aging period. Adjustments are provided to correct the

indicated frequency in terms of standard-frequency transmissions whenever necessary.

Quartz Crystal: TYPE 376-T.

Tube Complement:

3-6SJ7	1-5V4-G	1-2050
2-6AC7	1-6W6-GT	2-6SQ7-GT
2-6H6	1-0C3/VR105	

Coupling to Transmitter: A few inches of wire serving as an

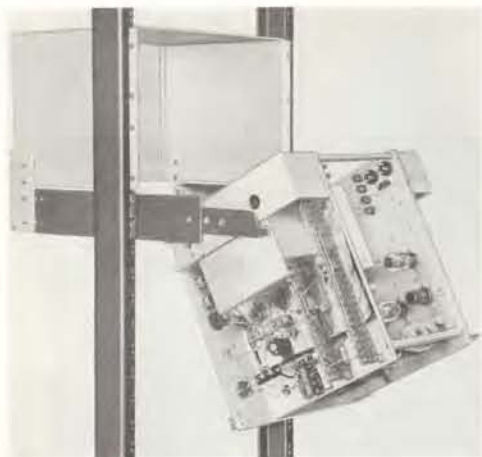

Monitor in rack extended and tilted for servicing.

antenna are usually sufficient. A minimum of 50 millivolts is required into a high-impedance grid circuit.

Accessories Supplied: Quartz crystal, 2 CAP-35 Power Cords, spare fuses, and plug for connecting an external meter.

Remote Indicator: External meter for local or remote deviation indication can be connected. Maximum external loop resistance: 5 kΩ.

Power Supply: 105 to 125 (or 210 to 250 volts), 50 to 60 cycles.

Power input receptacle will accept either 2-wire (TYPE CAP-35) or 3-wire (TYPE CAP-15) power cord. Two-wire cord is supplied. For 3-wire, see page 237.

Power Input: 25 watts for heater circuits, 100 watts for monitor circuits.

Mounting: 19-inch relay-rack panel.

Panel Finish: Standard General Radio crackle. Certain standard finishes which can be processed in quantity can also be supplied.

Dimensions: Panel (length) 19 × (height) 15¾ inches. Depth behind panel, 13 inches.

Net Weight: 51 pounds.

TYPE 1181-BT COLOR SUBCARRIER MONITOR 3.579545 Mc

The Color Subcarrier Monitor is similar to the broadcast models, but the quartz crystal is operated at a very low oscillation amplitude to achieve maximum long-term stability.

In color-TV transmitters, the standard color subcarrier-frequency signal of 3.579545 Mc is needed at any location where a color program originates, whether "live" or film. It is usually generated by an oscillator at that location, at or near a studio rather than at a transmitter. Although there is no specific

FCC requirement that this frequency be *monitored*, it must be held within ±10.7 cps at all times. Good operating practice, therefore, makes continuous monitoring very desirable. The TYPE 1181-BT Color Subcarrier Monitor is ideally suited for this application. Its stability of one cycle per month or five cycles per year obviates the necessity of frequency checks against an external source, while its price is less than half that of most counter-type frequency meters.

SPECIFICATIONS, TYPE 1181-BT

Same as for TYPE 1181-B except as specified below:
Input Frequency: 3.579545 megacycles; unmodulated.
Frequency Stability: ± one cycle per second for 30 days; ±5 cycles for one year.

Quartz Crystal: General Radio TYPE 376-R.
RF Sensitivity: .05 to 2.0 volts unmodulated rf input.
Coupling to Transmitter: Shielded cable and plug provided.

TYPE 1181-BH FREQUENCY DEVIATION MONITOR 1.6 to 15 MC

Identical in its circuitry and general arrangement to the TYPE 1181-B, this higher-frequency model operates in a frequency range that includes such services as aeronautical, maritime, marine, public safety, and international broadcast. While the present FCC frequency-stability requirements for these services

are 30 to 50 parts per million, the use of highly selective narrow-band receivers to minimize interference requires a considerably higher degree of carrier-frequency stability. The monitor is the least expensive and most reliable means of assuring the desired carrier accuracy.

SPECIFICATIONS, TYPE 1181-BH

Same as for 1181-B, except as noted below:
Frequency: 1.6–15 Mc.
Frequency Stability: ±1 ppm for 30 days, or better; ±5 ppm for 1 year.
RF Input: 1.6–5 Mc, 0.1–2.5 volts, modulated or un-

modulated.
5–15 Mc, 0.4–3.0 volts, modulated or unmodulated.
Quartz Crystal: General Radio TYPE 376-R.
Coupling to Transmitter: Shielded cable and plug provided.

Type		Code Word	Price
1181-B	Frequency Deviation Monitor.....	MALAY	\$1025.00
1181-BT	Color Subcarrier Monitor.....	MAJOR	1025.00
1181-BH	Frequency Deviation Monitor.....	MADAM	1025.00

PATENT NOTICE: See Note 15, page 8.





TYPE 1931-B AMPLITUDE-MODULATION MONITOR

FCC Approval No. 3-107



USES: The TYPE 1931-B Amplitude-Modulation Monitor is used to measure and to indicate continuously the percentage modulation of broadcast and other radio-telephone transmitters. The TYPE 1931-B Modulation Monitor performs the following specific functions:

1. Measurement of percentage of modulation on either positive or negative peaks.
2. Overmodulation indication.
3. Program-level monitoring.
4. Measurement of carrier shift when modulation is applied.
5. Measurement of the transmitter audio-frequency response.

DESCRIPTION: The TYPE 1931-B Amplitude-Modulation Monitor consists of three essential elements: a linear diode rectifier which gives an instantaneous output voltage proportional to the carrier envelope; a semi-peak voltmeter which gives a continuous indication of the peak modulation; a trigger circuit which flashes a light whenever the negative modulation peaks momentarily exceed any previous set value.

The linear rectifier is designed for operation at a low-power level, which greatly simplifies the coupling to the transmitter. A d-c meter in the output of the linear rectifier indicates the carrier level at which the instrument is operating and also shows any carrier shift during modulation.

In addition, two auxiliary audio output circuits operating from a separate diode rectifier are provided. One of these, at 600 ohms, is intended for audible monitoring; the other, a high-impedance circuit, gives a faithful repro-

duction of the carrier envelope with less than 0.1% distortion, under most conditions, and can be used for distortion and noise-level measurements with the General Radio TYPE 1932-A Distortion and Noise Meter.

The circuit for external meter connections permits the external loop resistance to be as high as 5000 ohms. A switch is provided to disconnect the external meter and connecting lines and to substitute an internal 5000-ohm resistor, in which event the monitor functions independently of external connections.

The TYPE 1931-B Monitor incorporates General Radio's new concept in mechanical design that gives convenience never before attained in an instrument of this type. Every operation in the installation, use, and maintenance of this new monitor can be handled from the front. You never need to go behind the instrument rack. The monitor slides out and tilts forward and back for easy access to tubes and adjustments. Chassis test jacks permit a rapid check of current and voltage at critical points in the circuit. The unique chassis marking is so comprehensive that most maintenance can be performed without the need for an instruction book or circuit diagram. The monitor is a-c operated and is mounted on a single relay-rack panel.

FEATURES:

- Initial installation, operation, and maintenance can be done from the front of the rack.
- Instrument marking enables most maintenance operations to be performed without reference to an instruction book or circuit diagram.



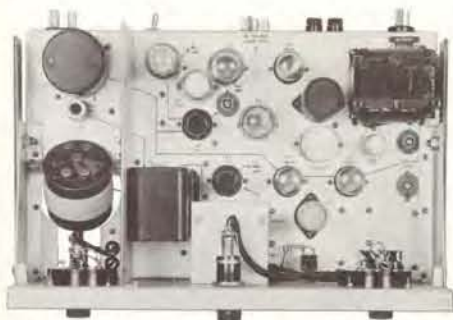

View of chassis showing signal flow lines.

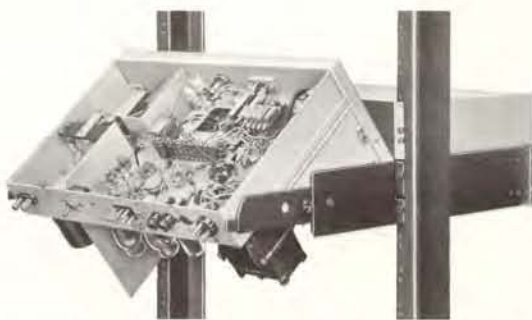

Monitor tilted to expose underside of chassis.

- Speed and simplicity of operation, essential for monitoring instruments, are available in this instrument.
- Operates over a wide carrier frequency range, and a tuned input circuit is provided to facilitate coupling to the transmitter.
- The r-f power input required in the broadcast range is less than 0.5 watt.

- Overmodulation indication.
- The flashing circuits are so designed that the indication is unaffected by moderate changes in carrier amplitude.
- Terminals are provided so that remote percentage modulation indicators can be connected to the instrument externally.

SPECIFICATIONS

Range: Modulation percentage, 0 to 110%, indicated by meter on positive peaks, 0 to 100% on negative peaks. The flashing lamp is adjustable to operate from 0 to 100% on negative peaks.

Carrier-Frequency Range: The monitor will operate at any carrier frequency from 0.5 to 60 megacycles. A single set of coils (either 0.5 to 8 megacycles or 3 to 60 megacycles) is supplied with each instrument, unless both sets are specifically ordered.

Carrier-Frequency Input Impedance: About 75 ohms in the broadcast band, increasing slightly at higher carrier frequencies and varying somewhat with input tuning.

Accuracy: The over-all accuracy of measurement at a modulating frequency of 400 cycles is $\pm 2\%$ of full scale at 0% and 100%, and $\pm 4\%$ of full scale at any other modulation percentage.

Detector Linearity: The distortion in the diode detector is very low for frequencies up to 7500 cycles. Above this frequency, a small amount of negative-peak clipping occurs, reaching 5% at the extreme high end of audio range at 15,000 cycles and 100% modulation.

R-F Power: In the broadcast range the maximum r-f power requirement is about 0.5 watt.

Warning Lamp Circuit: The OVERMODULATION lamp will flash whenever the negative modulation peaks exceed the setting of the MODULATION PEAKS dial by 2% or more modulation, for audio frequencies between 30 and 7500 cycles. For higher audio frequencies, the percentage overmodulation required to flash the lamp increases slightly.

The accuracy of the dial calibration is $\pm 2\%$ of full scale.

Meter Circuit: The response of the PERCENTAGE MODULATION meter circuit is flat, within ± 0.25 db, between 50 and 15,000 cycles, and within ± 0.1 db between 100 and 10,000 cycles.

Either positive or negative modulation peaks may be

read. Calibration in db below 100% modulation is provided.

The meter dynamic characteristic meets FCC specifications for modulation monitors.

Audio Monitoring Output: The audio output amplifier is flat, within ± 1.0 db, from 30 to 45,000 cycles. The internal impedance is 600 ohms. Distortion is less than 0.2%. Open-circuit output voltage is about 300 millivolts.

Fidelity-Measuring Output: Flat within ± 1.0 db between 30-30,000 cycles with TYPE 1932-A Distortion and Noise Meter connected. Distortion less than 0.1%, under most conditions.

Output level varies inversely with setting of MODULATION PEAKS dial, thus providing reasonably uniform input to distortion meter at all modulation levels. Average output level, approximately 1.5 volts, into 100k Ω load.

Residual noise and hum level will not exceed -80 db.

Auxiliary Output: A multipoint connector at the rear of the instrument provides a means of connecting:

1. A remote Percentage Modulation Meter.
2. To a 600-ohm output for audio monitoring.
3. The TYPE 1932-A Distortion and Noise Meter.

Power Supply: 105 to 125 (or 210 to 250) volts, 50 to 60 cycles. Power input is approximately 50 watts.

Power input receptacle will accept either 2-wire (TYPE CAP-35) or 3-wire (TYPE CAP-15) power cord. Two-wire cord is supplied. For 3-wire, see page 237.

Accessories Supplied: Multipoint connector TYPE CAP-15 Power Cord, spare fuses, and one set of input tuning coils (specify frequency range desired).

Mounting: The instrument is relay-rack mounted.

Panel Finishes: Standard General Radio crackle. Certain standard grays which can be processed in quantity can also be supplied.

Dimensions: Panel (length) 19 \times (height) 8 $\frac{3}{4}$ inches. Depth behind panel, 10 inches.

Net Weight: 32 $\frac{3}{4}$ pounds.

Type		Code Word	Price
1931-B	Modulation Monitor (.5 to 8 Mc)	TARRY	\$625.00
1931-B	Modulation Monitor (3 to 60 Mc)	TOPIC	625.00

PATENT NOTICE. See Note 15, page x.





POWER SUPPLIES

While most General Radio instruments have their own self-contained power supplies, some have been designed with plug-in power supplies for versatility and economy. These power supplies are also useful for general laboratory purposes because they combine small physical size with high quality and high performance.

Most of the General Radio Unit Instruments use plug-in power supplies. These instruments can all be operated from the general purpose TYPE 1203-B Unit Power Supply. For the ultimate performance in critical applications, the TYPE 1201-B Unit Regulated Power Supply provides constant voltage, greatly reduced ripple, and high current ratings.

The TYPE 1205-B Adjustable Regulated Power Supply is primarily a general purpose instrument which provides a regulated output adjustable from 0 to 300 volts at a maximum current of 200 milliamperes. An unregulated unit, the TYPE 1204-B Unit Variable Power Supply, provides 100

milliamperes continuously adjustable from 0 to 300 volts.

Any of these Unit Power Supplies can be used with any Unit Instrument. Unit Instruments in the rectangular type of cabinet can be solidly clamped together with the Power Supply and can be adapted for relay-rack mounting, if desired, by one of the TYPE 480-P Relay-Rack Adaptor Panels.

The TYPE 1263-A Amplitude Regulating Power Supply regulates the plate-supply voltage of the uhf and vhf unit oscillators to maintain a preset oscillator output voltage. This is particularly valuable when the oscillator is used for automatic display or plotting of amplitude response data.

For the operation of some General Radio battery-operated instruments from an ac line, the TYPE 1261-A Power Supply is available. This supply is interchangeable with the TYPE BA48 (or 6TA60) battery. Another model, the TYPE 1262-B Power Supply, is used for ac operation of the TYPE 1551-B Sound-Level Meter.

Type	Operated From	Output	Remarks	See Page
1203-B	115 v, 60 c	6.3 v, ac; 300 v, dc		143
1201-B	115 v, 60 c	6.3 v, ac; 300 v, dc	Regulated 300 v	143
1205-B	115 v, 60 c	6.3 v, ac; 0 to 300 v, dc	Regulated 0-300 v; -150 v	142
1204-B	115 v, 60 c	6.3 v, ac; 0 to 300 v, dc	Includes Variac®	143
1261-A	115 v, 60 c	1.5 or 3 v, dc; 133 v, dc, open circuit	Replaces BA48 Battery	145
1262-B	115 v, 60 c	1.2 and 1.5 v, dc; 69 v, dc, open circuit	Attaches to Sound Level Meter	145
1263-A	115 v, 60 c	6 v, dc; 0 to 250 v, dc	For Amplitude control on Unit Oscillators	144

TYPE 1205-B ADJUSTABLE REGULATED POWER SUPPLY



The Adjustable Regulated Power Supply is a small and compact unit for general laboratory use. Its adjustable output voltage, excellent regulation, high output, and low hum make it suitable for the most exacting applications. Output voltages are available at binding posts on the panel and at a multipoint connector in the side of the cabinet. Both the dc output voltage and the output current are indicated on a panel meter.

SPECIFICATIONS

DC Output Voltage: 0 to 300 volts, continuously adjustable at 200 ma, max.

Regulation: No load to full load, 0.1 volt; 0.75 volt change for $\pm 10\%$ change in line voltage.

120-Cycle Ripple: 1 millivolt.

Internal Impedance: Approximately $0.3 \Omega + 10 \mu\text{h}$.

Regulated Bias Voltage: -150 volts, dc, fixed at 5 ma, max.

Regulation: No load to full load, 0.5 volt $\pm 10\%$ line-

voltage change, 2 volts.

Unregulated AC Voltage: 2 circuits, 6.3 volts at 5a.

Meter Accuracy: Voltage, 2%; current, 5%.

Input: 105 to 125 volts, 60 c, 250 watts.

Tube Complement: 2-6AV5-GA, 2-5727, 1-12AT7, 1-6AN8, 1-6626, 1-5651, 1-6BZ7.

Dimensions: Panel, (width) $9\frac{1}{2} \times$ (height) $5\frac{1}{4}$. Depth behind panel, $5\frac{1}{8}$ inches.

Net Weight: 15 pounds.

Type	Code Word	Price
1205-B Adjustable Regulated Power Supply	APPLY	\$290.00





UNIT POWER SUPPLIES



TYPE 1203-B



TYPE 1201-B



TYPE 1204-B

Unit Power Supplies provide plate and heater power for Unit Instruments. Three types are available:

General-purpose unregulated—TYPE 1203-B

General-purpose regulated—TYPE 1201-B

Variac-controlled, unregulated—TYPE 1204-B

All models have aluminum panels and chassis, aluminum dust covers, and permanently attached power cords. A mating plug is supplied for connections to other equipment than Unit Instruments. These power supplies can be operated from a 400-cycle supply for applications where a 400-cycle filament supply may be used.

TYPE 1203-B UNIT POWER SUPPLY

Input: 105 to 125 volts, 50 to 60 c, 50 watts

Output: dc, 380 volts open circuit, 300 volts at 50 ma, all $\pm 5\%$; ac, 6.3 volts, 3 a.

120-Cycle Ripple: 80 millivolts

Accessories Supplied: Output plug; spare fuses.

Tube Complement: One 6X4.

Dimensions: Panel, (width) $4\frac{3}{4}$ \times (height) $5\frac{1}{4}$; depth behind panel, $5\frac{1}{8}$ inches.

Net Weight: 5 pounds.

Type		Code Word	Price
1203-B	Unit Power Supply, 105 to 125 volts	ALIVE	\$40.00
1203-BQ18	Unit Power Supply, 210 to 250 volts	ALIVERALLY	50.00

TYPE 1201-B UNIT REGULATED POWER SUPPLY

Input: 105 to 125 volts, 50 to 60 c, 90 watts

Output: dc, 300 volts $\pm 1\%$, regulated to 0.25%, 70 ma, max.; ac, 6.3 volts, unregulated, 4 a.

120-Cycle Ripple: Less than one millivolt.

Accessories Supplied: Output plug; spare fuses.

Tube Complement: One each 12AX7, 6AV5GT, 5651.

Dimensions: Panel, (width) $4\frac{3}{4}$ \times (height) $5\frac{1}{4}$; depth behind panel, $5\frac{1}{8}$ inches.

Net Weight: 6 pounds.

Type		Code Word	Price
1201-B	Unit Regulated Power Supply, 105 to 125 volts	ASSET	\$ 85.00
1201-BQ18	Unit Regulated Power Supply, 210 to 250 volts	ASSETRALLY	100.00

TYPE 1204-B UNIT VARIABLE POWER SUPPLY

An adjustable d-c plate voltage supply and a fixed a-c heater supply, both isolated from ground and from each other, are provided in the TYPE 1204-B Unit Variable Power Supply. They are available at insulated panel binding posts, and also at a multipoint connector mounted on the right-hand end, into which other Unit Instruments plug directly.

The d-c plate supply, is obtained from a pair of selenium rectifiers in a voltage-doubler circuit and is adjustable down to zero by a VARIAC® control. Both the d-c output voltage and the d-c load current are measured by a single switch-controlled panel meter.

Output Voltage: 6.3 volts a-c, nominal; 3 amperes maxi-

mum. The d-c output voltage is adjustable from zero to 300 volts with a maximum load of 100 milliamperes. Maximum no-load voltage, 400 volts.

Hum Level: About 250 millivolts at 300 volts, 100 milliamperes d-c load; about 150 millivolts at 350 volts, 50 milliamperes d-c load.

Input: 115 volts at 60 cycles; 75 watts at full output load. A line connector cord is permanently attached to the instrument.

Accessories Supplied: Output plug; spare fuses.

Dimensions: Panel, (width) $9\frac{1}{2}$ \times (height) $5\frac{1}{4}$; depth behind panel, $5\frac{1}{8}$ inches.

Net Weight: $9\frac{3}{4}$ pounds.

Type		Code Word	Price
1204-B	Unit Variable Power Supply, 105 to 125 volts	AGATE	\$100.00





TYPE 1263-A AMPLITUDE-REGULATING POWER SUPPLY

AUTOMATIC AMPLITUDE CONTROL FOR UNIT OSCILLATORS



In measurements by sweep methods, it is essential that the amplitude of the applied signal remain constant as a function of frequency. The Amplitude-Regulating Power Supply is designed to maintain constant output from General Radio Unit Oscillators and can be used with other oscillators if their power requirements are within the allowable range, and if a dc connection can be made to the oscillator cathode circuit for supplying plate-current control.

The power supply compares the dc potential developed by the oscillator output rectifier with an adjustable dc reference potential, and applies a rapid correction to the oscillator plate supply to minimize the difference. It also supplies dc power for the plate and the cathode heater of the oscillator. Since most oscillators are not equipped with output rectifiers, a crystal rectifier and appropriate connectors are necessary. Recommended types are listed in the specifications.

Owing to its very-high-speed response, the amplitude-regulating Power Supply is particularly useful when used with a Unit Oscillator and the TYPE 1750-A Sweep Drive (page 149) for oscilloscope display of amplitude-frequency characteristics.

SPECIFICATIONS

General: For use with an oscillator whose output can be controlled by varying plate voltage applied. D-C connection to oscillator cathode must be available. Can be used with TYPES 1211-B, 1215-B, 1209-B, and 1218-A (pages 113 to 115).

Plate Supply: 0-250 volts at 25 ma with a 105 (210) volt line. With a line voltage of 115-volts (or 230), up to 300 volts at 30 ma is available.

Heater Supply: 6 volts dc at 0.5 amperes at 115- or 230-volt line. (5.4 volts at 0.7a)

R-F Output Regulation: Can be set from 0.2 to 2 volts. Oscillators that can deliver a minimum of 2 volts into 50 ohms within stated plate-supply limitation will be regulated within ± 2 percent of the preset level. Output change with

rated line-voltage variation, less than 20 millivolts.

Response Time: Plate current is changed at a rate of 30 milliamperes per millisecond.

Output Meter: Internal dc vacuum-tube voltmeter, calibrated in terms of the rf voltage at the external output rectifier. Internal calibration means is provided for standardization of this meter with rectifier.

Power Input: 55 watts maximum at 115/230 volts.

Power Supply: 105 to 125 (or 210 to 250) volts, (50-60 cycles). Instrument will operate satisfactorily on power-supply frequencies up to 400 cycles, provided that the supply voltage is at least 115 volts.

Blanking: Phone-tip jacks provided. Connection to a contactor in the TYPE 1750-A Sweep Drive cuts off oscil-

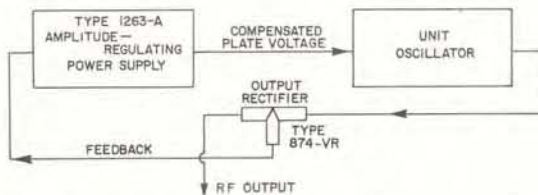

Block diagram of Type 1263-A Amplitude-Regulating Power Supply.

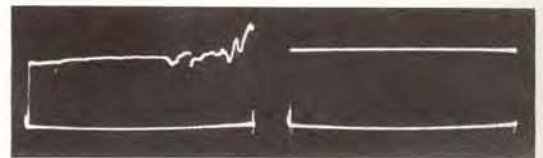

Oscillograms of output amplitude vs. frequency for the TYPE 1209-B Unit Oscillator (250 to 920 Mc) unregulated (left), and operated from the Amplitude-Regulating Power Supply (right). Oscillator was driven by the TYPE 1750-A Sweep Drive.





lator plate supply to eliminate vertical deflection during the return sweep, and to provide base line.

Tube Complement: Three 12AX7, one each, 6V6-GT, 0A2, 6X4.

Accessories Supplied: CAP-35 Power Cord, cable for Unit Oscillator connection, multipoint connector plug, spare fuses.

Other Accessories Required: TYPE 874-VR Voltmeter Rectifier, TYPE 274-NO Patch Cord and TYPE 874-QN6 Adaptor for connecting output rectifier.

Other Accessories Available: TYPE 874-VQ Voltmeter Detector (page 50) and TYPE 874-WM 50-ohm Termination (page 52) for use as a matched detector when frequency response measurements are made on 50-ohm circuits; TYPE 1750-A Sweep Drive (page 149) for automatic operation.

Dimensions: 13¼ (height) × 8¼ (width) × 7½ (depth) inches.

Net Weight: 18½ pounds.



TYPE 1263-A Amplitude-Regulating Power Supply supplying sweep-driven General Radio Unit Oscillator.

Type		Code Word	Price
1263-A	Amplitude-Regulating Power Supply	SALON	\$295.00
874-VR	Voltmeter Rectifier	COAXRECTOR	30.00
274-NO	Patch Cord.....	STANPARGAG	3.25
874-QN6	Adaptor.....	COAXCLOSER	1.00



TYPE 1261-A POWER SUPPLY

Interchangeable electrically and mechanically with BA48 (or 6TA60) battery. For use in place of batteries in:

TYPE 720-A Heterodyne Frequency Meter

TYPE 1231-B Amplifier and Null Detector

TYPE 1550-A Octave-Band Analyzer

Line cord is detachable. Uses one 6H6 tube and two Burgess UNI-Cell No. 2 or Eveready No. 950 batteries.



TYPE 1262-B POWER SUPPLY

Attaches to frame of the TYPE 1551-B Sound-Level Meter for use in place of batteries. Uses selenium rectifiers and RC filters.

Type	Volts	Frequency cps	Watts	Filament Supply Volts	Filament Supply ma	Plate Supply Volts	Plate Supply ma	Dimensions inches	Net Weight pounds	Code Word	Price
1261-A	105-125 OR 210-250	40 to 400	10	1.5 or 3	50	133	oc	10×5×2¼	7¾	NUTTY	\$128.00
1262-B	105-125 OR 210-250	50 to 400	2	#1	1.2	40	75	oc	5×7¼×3⅝	MAYOR	70.00
				#2	1.2	20	55	3.3			





RECORDERS AND DIAL DRIVES

The automatic display of data on oscilloscopes and graphic recorders has become an important factor in the conservation of engineering manpower and time. In the following pages are listed two types of instruments for data-display techniques: (1) a graphic-level recorder for frequencies up to 200 kc and (2) a group of mechanical dial drives, which adapt manual instruments for automatic sweep operation.

RECORDER

The TYPE 1521-A Graphic Level Recorder will plot the response of electrical and electro-acoustical devices as a function of frequency and the rms level of other phenomena as a function of time; it can also be used as a linear dc recorder. It can be coupled mechanically to drive the TYPE 1304-B Beat-Frequency Audio Generator and to the TYPE 1554-A Sound and Vibration Analyzer or the TYPE 760-B Sound Analyzer for automatic plotting over their respective frequency ranges.

DIAL DRIVES

The dial drives described in this section are mechanical accessories for already existing instruments that will convert them to automatic operation. Good quality, manually adjustable instruments of most kinds can be easily adapted for automatic display work. The vastly improved efficiency of the converted instrument will pay for the conversion many times over.

Sweep Drive

The most flexible of these is the TYPE 1750-A Sweep Drive. Adjustable over a wide range of angular displacement and speed, this device can be attached to a knob, dial, or shaft to operate as a robot hand that will turn the shaft back and forth in a prescribed manner. This sweep drive supplies a dc voltage proportional to angle, that serves as a position indicator.

Synchronous Drives

The TYPE 907-R and 908-R Dial Drives can be used to perform the same function at lower cost but with less flexibility. Driven by a synchronous motor, each model is



Oscillograms of the frequency characteristic of a 76-Mc Rejection Filter. Sweep range is 48 to 900 Mc. Oscillator is driven by the TYPE 1750-A Sweep Drive and the TYPE 1263-A Amplitude-Regulating Power Supply. Vertical deflection is square-law.

Plot of the frequency response of a public-address system made on the TYPE 1521-A Graphic Level Recorder, which was coupled mechanically to drive the frequency dial of the TYPE 1304-B Beat-Frequency Audio Generator.

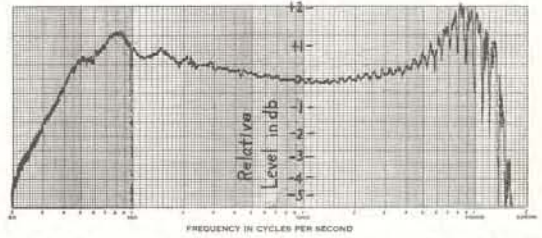

Graphic record of the frequency response of a tape recorder. Source was a TYPE 1304-B Beat-Frequency Audio Generator, driven by a TYPE 908-R96 Dial Drive. The vertical line at 100 cycles is the frequency calibration reference.

restricted to one speed. The low-speed models are designed for only one traverse without resetting and do not reverse.

The TYPE 908-P1 and 908-P2 Synchronous Dial Drives are extremely simple drives. To achieve the lowest possible cost, consistent with utility, they depend upon the known constant-speed characteristic of the synchronous motor to supply position information. They can be set to cover different angles of dial rotation, and they reverse automatically to yield an oscillating motion.

SLOTTED-LINE DRIVE

The TYPE 874-MD is a motor drive specifically designed to attach to the TYPE 874-LBA Slotted Line. This drive can be set to provide reciprocating traverse over a wide range of horizontal displacements at continuously adjustable speeds. Like the TYPE 1750-A Sweep Drive it provides position information from a dc voltage developed across a potentiometer ganged to the probe carriage.

AMPLITUDE CONTROL

An essential characteristic of sweep oscillators, in particular, is constancy of output with frequency. The TYPE 1263-A Amplitude Regulating Power Supply, when used with General Radio Unit Oscillators, provides a means of maintaining constant output.

Type		See Page
1521-A	Graphic Level Recorder	147, 8
1750-A	Sweep Drive	149, 50
907-R	Dial Drives	152
908-R	Dial Drives	152
908-P	Synchronous Dial Drives	151
1263-A	Amplitude Regulating Power Supply	144
874-MD	Slotted-Line Motor Drive	45

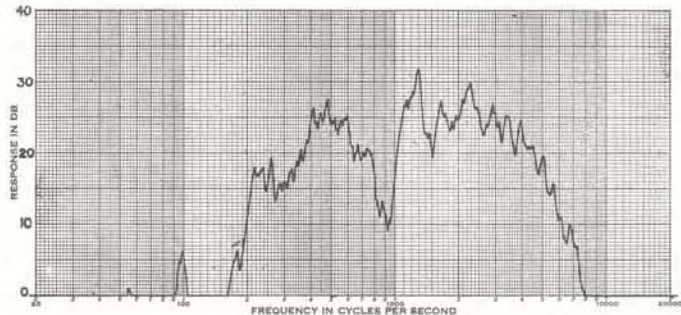

TYPE 1521-A GRAPHIC LEVEL RECORDER

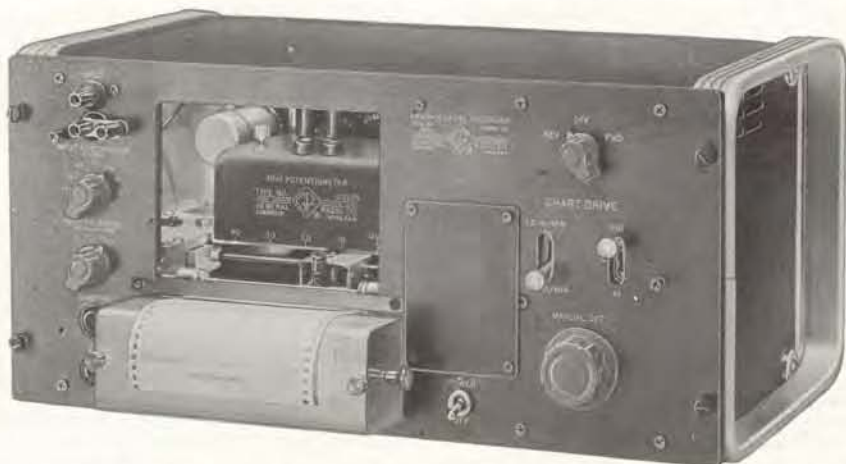

USES: The Graphic Level Recorder plots linearly in decibels the rms level of ac voltages from 20 cycles to 200 kc. It produces permanent ink records of the response of electrical or electroacoustic devices and systems as a function of either frequency or time. Owing to the high stability of its reference voltage and amplifier gain, it can be used as a recorder of absolute level.

For frequency-characteristic measurements, the paper drive can be coupled to the frequency-control shaft of an oscillator or analyzer to yield a permanent record with a minimum expenditure of time and effort. For measurements of level as a function of time the writing speed is sufficiently high for the measurement of reverberation time and other transient phenomena.

The combination of the recorder and the TYPE 1304-B Beat-Frequency Audio Generator produces records having a true logarithmic frequency scale and is ideal for plotting frequency characteristics of analyzers, recording systems, networks, filters, and equalizers, as well as of loud speakers, microphones, vibration pickups, and other transducers.

The combination of the recorder and either the TYPE 1554-A Sound and Vibration Analyzer or the TYPE 760-B Sound Analyzer makes possible automatic analysis of sound spectra, and response measurements on networks excited by white noise.

The wide range of paper speed facilitates long-period studies of the noise produced by traffic, office machinery, industrial processes and potential hearing-damage conditions, as well as of short-duration transients.

Accessory potentiometer units are available for a wide variety of scales for ac recording. They are supplemented by a linear potentiometer which converts the instrument from a level recorder to a general-purpose dc recorder.

DESCRIPTION: The TYPE 1521-A Graphic Level Recorder is a completely transistorized single-channel, servo-type recorder. It produces a strip-chart record with ink on white paper, suitable for reproduction.* The pen is attached to a coil which moves linearly over a 4-inch distance in a uniform magnetic field. A contact attached to the coil rides on a straight potentiometer which serves as the balancing element for the servo. The position of the contact is determined by the input signal, and the exponential potentiometer characteristic produces a linear db scale.

The detector circuit, which has essentially rms response ("quasi-rms")†, rectifies the input signal. For all commonly encountered waveforms, including multiple sine waves, random noise and rectangular waves of duty ratio greater than 50:1 the response very closely approximates true rms. The detector operates at a level of one volt, and an ac amplifier with a gain of 1000 produces an input sensitivity of 1 mv at the zero db level. This sensitivity can be decreased in accurate 10 db steps over a 60 db range by the input attenuator.

The difference between the detector output and a one-volt reference derived from a Zener diode is amplified by a stable dc amplifier and used to position the coil which carries the potentiometer contact and pen. A velocity-feedback coil mounted on the drive-coil frame provides appropriate damping.

Careful design has made it possible to maintain both a high writing speed and the largest servo bandwidth consistent with a frequency response extending downward to 20 cycles without exceeding a 1-db overshoot. Writing speeds of approximately 1, 3, 10, and 20 inches per second are selectable by a single switch without auxiliary adjustment of low-frequency cut-off or damping.

Changes of the recording range are easily accomplished by interchanging for the 40-db potentiometer supplied as standard equipment either 20-db or 80-db potentiometers as desired. With the 80-db potentiometer the maximum writing speed becomes 400 db/second, making possible measurement of reverberation times as short as 0.3 second. The slow writing speeds are provided to filter out abrupt level variations, yielding a smoothed plot. Careful analysis and control of factors influencing dynamic behavior make possible this smoothing without loss of accuracy.

Terminals are provided for an external dc reference voltage, which can be substituted for the 1-volt internal dc reference. The recorder will operate properly over a 3:1 reference-voltage range (0.5 to 1.5 volts). If this reference voltage is derived from the source of energy in the system under test, variations of up to 3:1 in the source output can therefore be eliminated from the recording.

For dc recording the potentiometer, ac amplifier, and detector are removed from circuit. The linear potenti-

† E. E. Gross, "Improved Performance Plus a New Look for the Sound-Level Meter," *General Radio Experimenter*, 32, 17, October, 1958.

* See sample record on page 146.



ometer, in this method of connection, provides a balancing voltage in series with the input voltage, and the combined voltage is balanced against the 1-volt reference. A single 0.8-volt range at a 1000-ohm input-impedance level makes the instrument interchangeable with the usual direct-writing strip-chart recorders.

FEATURES:

- High input sensitivity.
- Calibrated in absolute level.

- Wide input frequency range.
- Fast writing speed with optimum ballistics.
- Simple to operate.
- RMS detector.
- Mechanical coupling available for driving oscillator or analyzer.
- Interchangeable logarithmic potentiometers.
- Easily converted to dc linear recorder.
- Completely transistorized.

SPECIFICATIONS

Input Frequency Range: 20 cps to 200 kc, for level recording; servo bandwidth, dc to 10 cps.

Input Range: 0 to 40 db for level recording (20-db and 80-db potentiometers are also available); 0-0.8 volts (at 1000 ohms) full scale for dc recording with zero input position adjustable over full scale.

Accuracy: Potentiometer balances within 0.5% of full scale.

Maximum Sensitivity: 1 millivolt at 0 db for level recording; 0.8 volts full scale for dc recording.

Maximum Input Voltage: 100 volts ac.

Input Impedance: 10,000 ohms for ac level recorder
1000 ohms for dc recorder

Paper Speeds: 2.5 inches per minute to 75 inches per minute. A slow-speed motor to provide speeds of 2.5 to 75 inches per hour is available as an accessory.

Writing Speed: 1, 3, 10, or 20 inches per second (approximately), with overshoot less than 1 db.

Detector: Quasi-rms; within 0.25 db of rms for multiple

sine waves, square waves, or noise.

Chart: 4-inch recording width on 5-inch paper. All charts have 8 major divisions, 40 total divisions on vertical scale.

Transistor Complement: 12-2N169A, 4-2N321, 2-2N301, 1-2N235A.

Accessories Supplied: Spare fuses, power cord, 2 pens, 2-oz. bottle of ink, 40-db pot, 1 roll of CTP-505 paper.

Accessories Available: Potentiometers, charts, ink, slow-speed motors, and link units; as listed in price table.

Power Supply: 105 to 125 (or 210 to 250) 60 cycles, 35 watts. 50-cycle models are available, see price list below.

Power input receptacle will accept either 2-wire (TYPE CAP-35) or 3-wire (TYPE CAP-15) power cord. Two-wire cord is supplied. For 3-wire, see page 237.

Dimensions: (Height) 9 × (width) 19½ × (depth) 14¼ inches, over-all. Available for bench or relay-rack mounting.

Net Weight: 50 pounds.

Type		Code Word	Price
1521-AR	Relay-Rack Model, for 60-cycle supply	AGENT	†
1521-AM	Bench Model, for 60-cycle supply	ASTER	†
1521-ARQ1	Relay-Rack Model, for 50-cycle supply	AGENTRABID	†
1521-AMQ1	Bench Model, for 50-cycle supply	ASTERRABID	†

PATENT NOTICE. See Note 18, page x.

POTENTIOMETERS FOR OTHER RANGES

1521-P1	20-db Potentiometer	FACET	†
1521-P3	80-db Potentiometer	FELON	†
1521-P4	Linear Potentiometer, for dc recording	FAUNA	†

CHARTS

CTP-501	Calibrated 20 cps-20 kc, logarithmic, in 9 inches, repeating every 12 inches along time axis; for use with Type 1304-B Beat-Frequency Oscillator.	LOGARCHART	\$2.30*
CTP-505	Linear time base, 1 division = ¼ inch; for ac or dc records as a function of time.	LINALCHART	2.30*
CTP-516	Calibrated 25-7500 cps in ½ decade segments, scale 2¼ inches long, spaced for continuous rotation of analyzer knob; for use with Type 760-B Sound Analyzer.	SOUNDCHART	2.30*
CTP-554	Calibrated 25-25,000 cps along time axis; for use with Type 1554-A Sound and Vibration Analyzer.	ANNALCHART	2.30*

All charts are 5 inches wide and have 8 major divisions on a 4-inch vertical scale with 40 total divisions. Roll length 100 feet. All may be used with any potentiometer.

INK (red)

1521-409	2-ounce bottle	INKAL	\$0.85*
1521-409-2	16-ounce bottle	INKER	3.00*

* Subject to quantity discounts.

MOTORS FOR LOWER CHART SPEED

1521-P20	(60 cycles) for paper speeds of 2.5-75 inches/hour.	PASTY	†
1521-P22	(50 cycles) for paper speeds of 2.5-75 inches/hour.	PERIL	†

DRIVE AND LINK UNITS FOR COUPLING TO OSCILLATOR AND ANALYZERS

1521-P10	Drive Unit to operate all link units.	PUPIL	†
1521-P11	Link Unit for coupling to Type 1304-B.	PRIOR	†
1521-P12	Link Unit for coupling to Type 760-B.	PUPPY	†
1521-P13	Link Unit for coupling to Type 1554-A.	PUTTY	†

† Prices not available at time of printing.





TYPE 1750-A SWEEP DRIVE

FOR WIDE-RANGE

AUTOMATIC

DATA DISPLAY



USES: Measurements by sweep methods over wide frequency ranges are made possible and practical with the TYPE 1750-A Sweep Drive, which adapts manually-operated equipment to sweep operation. It can be used in the display of any electrical quantity as a function of the shaft angle of the device being swept and can be adjusted to sweep in reciprocating motion any arc up to 300 degrees, at speeds up to 5 per second. Its universal coupler attaches easily to any knob, dial, or shaft. Used in conjunction with Unit Oscillators (see page 109), it makes available an extremely versatile system of swept signal sources covering a frequency span from 0.5 Mc to 2000 Mc. For a constant output over the entire frequency range of any one of the Unit Oscillators, the TYPE 1263-A Amplitude Regulating Power Supply is used. (See page 145). Provision is made in the Sweep Drive for the generation of deflection voltages for a cathode-ray oscillo-

scope, to present visual displays of circuit characteristics.

DESCRIPTION: The Sweep Drive is powered by a small motor, which drives the output shaft through an adjustable rack and a differential. Sweep frequency is determined by the motor speed, sweep arc is determined by the adjustable rack, and sweep center position is controlled through the differential. All adjustments can be made while the drive is in motion. An adjustable limit switch can be set to stop the drive when predetermined limits of motion of the driven shaft are exceeded. The limits can be set up to nine full turns of the driven shaft. Any 300-degree of the nine-turn range can be swept at one setting of the sweep-arc control. Other 300-degree arcs may be swept by varying the center position control.

An oscilloscope-deflection-voltage circuit provides a horizontal deflection voltage that



Production testing a crystal filter for i-f shaping. The filter operates at 13 Mc and has a 30-kc bandwidth. The sweep frequency is supplied by the TYPE 805-C Standard-Signal Generator, whose slow-motion dial is driven by the TYPE 1750-A Sweep Drive. *Courtesy Hycon Eastern*

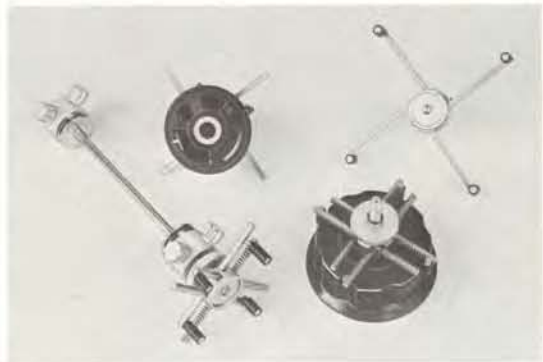

View of the coupling attachments furnished with the Sweep Drive. At left is the coupling shaft, to which has been attached the universal clutch. The other views show the clutch and the clutch attached to a knob.





is proportional to shaft angle. A blanking circuit is included to eliminate the oscilloscope return trace, and produce a base line.

FEATURES:

- Adapts manually operated equipment for automatic data presentation.
- Can be attached to any dial, shaft, or knob.
- Three dials adjust sweep speed, sweep arc, sweep center while the drive is in motion.
- Generates horizontal deflection voltage proportional to shaft angle.
- Adjustable limit switches protect against exceeding pre-set limits of shaft travel.

Characteristic of a television front-end tuner set to channel 7; sweep range is 160 to 200 Mc; vertical deflection is square law.

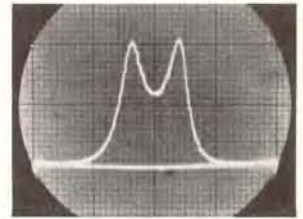

- Provides a constant-output swept oscillator when used with Unit Oscillator and TYPE 1263-A Amplitude Regulating Power Supply.
- Brings sweep techniques to the laboratory or production line at minimum cost.

SPECIFICATIONS

Reciprocating Output Shaft:

- Center Position: Adjustable over 9-turn range.
- Sweep Arc: Adjustable 30-300 degrees.
- Torque: Rated max. 24 ounce-inches. Will drive all variable-frequency Unit Oscillators and General Radio Standard-Signal Generators.
- Sweep Speed: Adjustable 0.5-5 cycles per second. Moment of inertia limits the speed at which a load can be driven.
- Height of Shaft: Adjustable from 2½-4⅞ inches over bench.
- Flexible Coupling: 5¾ inches long.
- Provision for Coupling: Shaft diameters, ¼ and ⅜

- inches; knobs and dials, 1 to 4 inches. Continuously adjustable.
- Limit Switch: Adjustable within 9 turns.
- Sweep Voltage: 2.5 volts peak to peak, ungrounded.
- Blanking: Shorting contact closed during clockwise rotation of driven shaft, ungrounded.
- Accessories Supplied: Couplings, tube of lubricant, spare fuses.
- Input Power: 105-125 volts, 50-60 cycles, 60 watts maximum. 210- to 250-volt model also available. See price list.
- Dimensions: 17½" wide, 9" high, 8¼" deep.
- Weight: 22½ pounds.

Type		Code Word	Price
1750-A	Sweep Drive (115 volts, 50-60 cycles)	STUDY	\$460.00
1750-AQ18	Sweep Drive (230 volts, 50-60 cycles)	STUDYREPEL	495.00

For a complete sweep system for use with a Unit Oscillator, as illustrated below, add the following:

Type		Page
1263-A	Amplitude-Regulating Power Supply.....	145
874-VR	Voltmeter Rectifier	50
274-NO	Patch Cord.....	237
874-QN6	Adaptor.....	236
874-VQ	Voltmeter Detector*	50
874-WM	50-ohm Termination*	52

*Used when 50-ohm systems are measured, to rectify the output of the network under test and to provide vertical deflection voltage.



TYPE 1750-A Sweep Drive and the TYPE 1263-A Amplitude Regulating Power Supply set up to sweep a TYPE 1209-B Unit Oscillator, thus providing a constant sweep output over a frequency span of 250 Mc to 920 Mc. The equipment shown here is listed above, with the exception of the oscillator.

AUTOMATIC SWEEP DRIVE FOR THE SLOTTED LINE

For the automatic sweeping of the slotted-line, which is used in VHF and UHF measurements, see page 45.



AUTOMATIC DIAL DRIVES

Sweeping techniques that utilize oscilloscopes for visual indications and recorders for permanent records are becoming more and more popular. An inexpensive solution to adapting manually-operated equipment to sweep operation is the TYPE 908-P Synchronous Dial Drives or the TYPES 907-R and 908-R

Dial Drives. For equipment that uses TYPE 907 or 908 Dials, these dial drives replace the knob with a motor drive directly. For equipment that does not use TYPE 907 or 908 Dials, replacing the original dial with a TYPE 907 or 908 (see page 232), will make the shaft sweepable with these Drives.

TYPE 908-P SYNCHRONOUS DIAL DRIVES



USES: Two synchronous dial drives, differing only in speed and torque output, are available for use on all TYPE 907 and 908 Precision Gear-Drive Dials. The TYPE 908-P1 is intended for use with a graphic recorder, since its synchronous motor supplies a convenient time base.

The TYPE 908-P2 with a higher speed, although also useful with a recorder, is particularly suitable (on low-torque instruments) for limited sweep applications using an oscilloscope with a long-persistence screen for visual display.

DESCRIPTION: The dial drives have a synchronous motor that reverses its direction whenever it encounters a mechanical stop. To limit the sweep range to a value less than that provided by the built-in dial stops, adjustable stops that attach to the dial are provided. A pinion gear on the output shaft, a disengage lever, and a power switch and cord are provided.

SPECIFICATIONS

SPEED:

Type	Pinion	908 Dial	907 Dial
908-P1	4 RPM	4/15 RPM or 225 secs/rev	4/10 RPM or 150 secs/rev
908-P2	30 RPM	2 RPM or 30 secs/rev	3 RPM or 20 secs/rev

Power Supply: 105 to 125 volts, 50-60 cycles.

Dimensions: 3 5/8-inch diameter x 3 inches deep, over-all, excluding power cord.

Weight: 1 pound, 3 ounces.

On logarithmic frequency dials used on TYPES 1304 and 1303-A Oscillators, the sweep times are as follows:

908-P1 50 sec/frequency decade or 15 sec/octave.

908-P2 6 2/3 sec/frequency decade or 2 sec/octave.

These data are for 60-cycle operation. Multiply speeds by 5/6 for 50-cycle operation.

Torque at Pinion: 908-P1 5-inch ounces; 908-P2 2 2/3 inch-ounce. TYPE 908-P1 will drive the following oscillators: TYPES 1208-B, 1209-B, 1209-BL, 1211-B, 1215-B, 1210-C, 1330-A, and 1304-B. It will also drive the TYPE 1218-A, but the life of the drive is reduced. TYPE 908-P2 will drive the TYPES 1209-B, 1209-BL, 1210-C, 1211-B, 1215-B, and 1304-B very satisfactorily. It is not recommended for use with TYPE 1208-B. It will not drive the TYPE 1218-A.



TYPE 908-P2 Synchronous Dial Drive mounted on a TYPE 1304 Beat-Frequency Audio Generator.

Type		Code Word	Price
908-P1	Synchronous Dial Drive	SYNDO	\$29.00
908-P2	Synchronous Dial Drive	SYNKA	29.00

DIALS FOR USE WITH THESE DRIVES—See page 232 for TYPE 907 and 908 Gear-Drive Precision Dials.

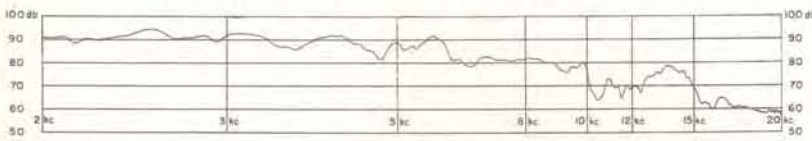

Frequency characteristic of a small loudspeaker, driven by TYPE 1210 Unit RC Oscillator and TYPE 908-P1 Dial Drive.



TYPE 907-R AND 908-R DIAL DRIVES



TYPE 907-R Dial Drive mounted on a TYPE 1208-B Unit Oscillator.

USES: In automatic recording it is desirable to have a sweep voltage proportional to shaft position. This sweep voltage is used to drive the independent variable axis of an x-y plotter or an oscilloscope, or a separate channel on

a single-axis recording system. These dial drives include a potentiometer to supply this sweep voltage. In oscilloscope work, because of the relatively slow sweep speeds, oscilloscope tubes with long-persistence screens (P-7 phosphor) should be used.

DESCRIPTION: The higher-speed models operate with a self-reversing synchronous motor in the same way as the TYPE 908-P Synchronous Dial Drives. The lower-speed models drive the dial in a counter-clockwise (increasing frequency on GR oscillators) direction only. A friction clutch is supplied to prevent damage if the motor is permitted to run after the dial has reached its stop. The synchronous motors used in these drives provide a convenient time base for recorder plots.

When mounted, the drive motor may be disengaged from the dial for manual operation of the instrument with a direct-coupled knob on the dial drive. This knob is also used to center the potentiometer about any dial setting.

For use with a wide range of d-c output levels, and, therefore, with a wide variety of recorders, binding posts are provided for the insertion of a selected d-c supply voltage to the drive potentiometer. Binding posts are also available for the position signal output. A power switch and cord are included.

SPECIFICATIONS

Power Supply: Motor: 105-120 volts, 50-60 cycles, 3 watts. Potentiometer, see below.

Dimensions: 907-R 4 (diameter) × 3⁷/₈ (deep) inches.
908-R 5³/₄ (diameter) × 3⁷/₈ (deep) inches.

Weight: 907-R one pound, 11 ounces.
908-R two pounds.

Note: Data are for 60-cycle operation. Multiply speeds by ²/₃ for 50-cycle operation.

Type	Dial	Pinion Speed	Dial Speed	Rotation	Center-tapped Potentiometer Resistance	Max Potentiometer Current	Resolution
907-R18	907	1/2 RPM	18°/min	CCW	20 kΩ	10 ma	0.4°
907-R144	907	4 RPM	144°/min	Self-reversing	20 kΩ	10 ma	0.4°
908-R12	908	1/2 RPM	12°/min	CCW	50 kΩ	10 ma	0.2°
908-R96	908	4 RPM	96°/min	Self-reversing	50 kΩ	10 ma	0.2°

The TYPE 907-R18 and -R144 will drive the following instruments: TYPES 1210-C, 1208-B, 1209-B, 1209-BL,

1554-A. The TYPE 908-R12 and -R96 will drive TYPES 1211-B, 1215-B, 1218-A, 1001-A, 1021-A, 1304-B, 1330-A.

Type	Code Word	Price
907-R18 Dial Drive	EARLY	\$55.00
907-R144 Dial Drive	EDUCE	55.00
908-R12 Dial Drive	EGRET	55.00
908-R96 Dial Drive	EJECT	55.00

DIALS FOR USE WITH THESE DRIVES—See page 232 for TYPE 907 and 908 Gear Drive Precision Dials.



RESISTORS



Because of accuracy of adjustment, long-time stability, low and uniform temperature coefficient, and relative immunity to ambient humidity conditions, the wire-wound resistor is the most suitable type for use as a laboratory standard at audio and low-radio frequencies, as well as at dc. In the resistance range from a fraction of an ohm to about one megohm such resistors have been developed to a high state of refinement through improvements in resistive alloys and in design and manufacturing techniques. The wire-wound resistors in the form of fixed elements, individual decades, and decade assemblies ("decade boxes") described on the following pages are designed for a-c use as well as for d-c.

Resistors designed for a-c use differ from those intended for use only at direct current in that low series reactance and constancy of resistance as frequency is varied are important design objectives. Inevitably, resistors have capacitance and inductance associated with them, and these residual reactances become increasingly important as the frequency is raised, acting to change the terminal resistance from its low-frequency value.

For frequencies where the resistance and its associated residual reactances behave as lumped parameters, the equivalent circuit of a resistor can be represented as shown in Figure 1. The inductance L is the equivalent inductance in series with the resistance, while the capacitance C is the equivalent capacitance across the terminals of the resistor.

To analyze the behavior of the equivalent circuit as frequency is varied, it is necessary to differentiate clearly between the concepts of equivalent series and equivalent parallel circuits. The two-terminal circuit of Figure 1 can be described as an impedance, $R_s + jX_s$,

or as an admittance, $G + jB$ $\left(= \frac{1}{R_p} + \frac{1}{jX_p} \right)$,

wherein the parameters are a function of frequency. This distinction between series and parallel components is more than a mathematical exercise—the use to which the re-

sistor is put will frequently determine which component is of principal interest.

The expressions for the effective series resistance (R_s) and the effective series reactance (X_s) of Figure 1 are:

$$R_s = \frac{R}{\left[1 - \left(\frac{\omega}{\omega_0} \right)^2 \right]^2 + (R\omega C)^2} \quad (1)$$

$$X_s = \frac{\omega \left\{ L \left[1 - \left(\frac{\omega}{\omega_0} \right)^2 \right] - R^2 C \right\}}{\left[1 - \left(\frac{\omega}{\omega_0} \right)^2 \right]^2 + (R\omega C)^2} \quad (2)$$

where $\omega_0 = \frac{1}{\sqrt{LC}}$ and $\left(\frac{\omega}{\omega_0} \right)^2 = \omega^2 LC$ (3)

The effective parallel components are given by:

$$G = \frac{1}{R_p} = \frac{1}{R \left[1 + \omega^2 \left(\frac{L}{R} \right)^2 \right]} \quad (4)$$

$$B = -\frac{1}{X_p} = \omega C - \frac{1}{\omega L \left[1 + \frac{1}{\omega^2} \left(\frac{R}{L} \right)^2 \right]} \quad (5)$$

At frequencies sufficiently low that terms involving the square of frequency are negligible, the resistor may be represented by a two-element network consisting of the d-c resistance, R , in series with an inductance equal to $L - R^2 C$ or in parallel with a capacitance

equal to $C - \frac{L}{R^2}$. Because of the presence of the

R^2 term in the equivalent reactive parameters, shunt capacitance is the dominating residual for high values of resistance, while for low values of resistance the series inductance invariably predominates. It is, in fact, a common fallacy to speak of "non-inductive" resistors in resistance values where shunt capacitance controls, and variations in inductance of the winding can have no significant effect on the reactive component.

In the simplified circuit described above, the effective parallel resistance of a resistor in which shunt capacitance dominates would be independent of frequency. Actually, other effects may cause the parallel resistance to decrease with frequency. For example, dielec-

FIGURE 1. Equivalent circuit of a resistor showing the residual impedances associated with the resistance.

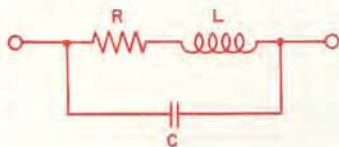

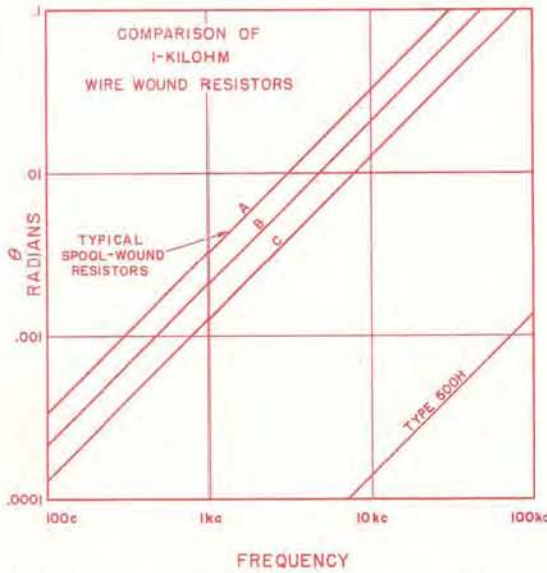

FIGURE 2. Phase angle as a function of frequency for a General Radio mica-card resistor and for three commercial wire-wound types.

tric losses in the shunt capacitance, C , of Figure 1 are equivalent to a resistance

$$R_d = \frac{1}{D\omega C}$$

which decreases with increasing frequency and causes even the parallel resistance to decrease rapidly beyond a certain frequency. That portion of the shunt capacitance, C , which is distributed causes a similar rapid decrease in resistance, even if its dielectric loss is negligible.

General Radio wire-wound resistance elements are designed to minimize inductance in low-resistance values and to minimize capacitance for high values of resistance. All units up through 100 ohms utilize a so-called Ayrton-Perry winding, in which each resistor consists of two parallel windings of opposed direction, so that the current flow in the two windings is in opposite directions. The external magnetic field, as a result, is effectively canceled so that, typically, the residual inductance of such a winding is of the order of 1% of the inductance of a corresponding single winding.

Elements having 200 ohms resistance or higher are unifilar-wound on their flat rectangular "cards". The inherent phase angle of these resistors is substantially lower than that obtained with so-called "non-inductive" spool-wound resistors commonly used commercially.

Wire-wound resistors of these types exhibit a negligible frequency error in resistance up

to about 500 kc, for values of resistance up to 500 ohms, and only moderate errors at one megacycle.

When assembled into decades, these resistors have added to their own residual impedances those of the switches, wiring, and cabinet. The equivalent circuit is then that of Figure 3, which represents a single decade of the 510 type. For assemblies of such decades in the TYPE 1432 Decade Resistor the same circuit is still valid. The incremental inductances of the several decades in the circuit are additive, but the capacitance is approximately that of highest decade in use. Typical values of the residual impedances for the various types of General Radio resistors are given in the specifications for each type.

It should be noted that the effect of the residual reactance depends greatly upon the way the resistor is connected into a circuit. Reactances can often be tuned out, particularly in parallel circuits. This is a particularly important consideration with the higher-valued resistors of 10,000 ohms and above. When the resistor is used as a parallel circuit element, the upper limit of frequency for a given error is some 10 times higher than for the series connection.

Probably the best known resistance alloy is manganin, used for over half a century in the manufacture of precision resistors. This old established alloy is still the most suitable for low values of resistance. For higher values, where small-diameter wire is required, more modern, proprietary alloys have been demonstrated to be superior. Such alloys are characterized by low, positive temperature coefficients, substantially constant over a wide range of temperature. They have, in addition, negligible thermal emf against copper, high tensile strength, relative immunity to the effects of humidity and atmosphere, and are relatively insensitive to strain. These newer alloys are used in all GR precision resistors of 40 ohms and above.

FIGURE 3. Equivalent circuit of a resistance decade, showing location and nature of residual impedances.

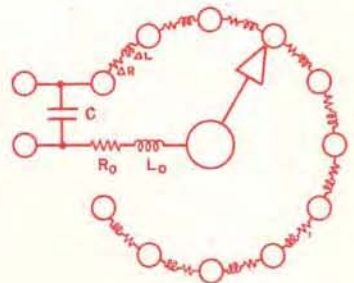

TYPE 1432 DECADE RESISTOR

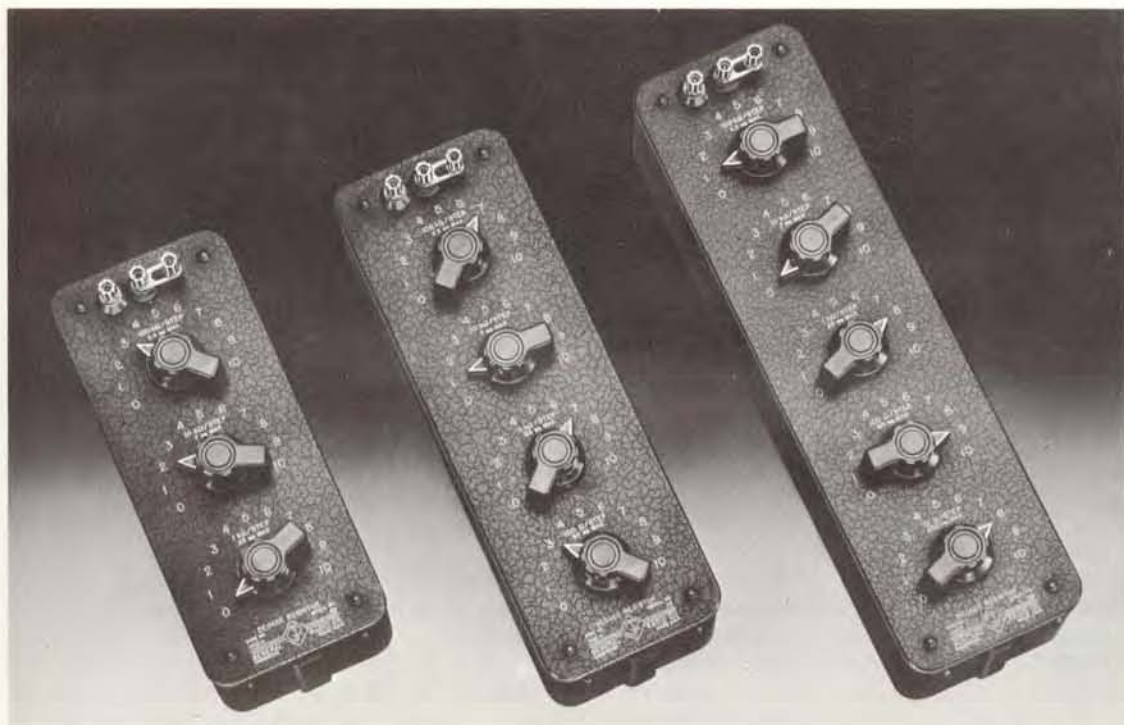

USES: Accurate decade resistors are necessary wherever electrical measurements are made. They are used in circuits where a wide range of resistance values is required or where variable dummy generator and load resistances are needed. The accuracy of TYPE 1432 Decade Resistors easily meets the requirements of these applications and also permits them to be used as laboratory standards and as ratio arms for direct- and alternating-current bridges.

Although designed primarily for direct-current and audio-frequency work, many of the models are useful well into the radio-frequency range.

General Radio decade resistors are the standard of the industry. They have been manufactured continuously since 1915 and have been constantly improved in accuracy, stability, and appearance through the use of the finest available materials and manufacturing techniques.

DESCRIPTION: The TYPE 1432 Decade Resistor is an assembly of TYPE 510 Decade-Resistance Units in a single cabinet. Mechanical as well as electrical shielding of the units is provided by the attractive aluminum cab-

inet and panel, which completely enclose both the resistance units and switch contacts. The resistance elements have no electrical connection to the cabinet and panel, for which a separate shield terminal is provided.

Three-, four-, and five-dial decade assemblies are available. Each decade has eleven contact studs and ten resistance units, so that the dial values overlap. Positive detent mechanisms in conjunction with bar-type knobs permit the operator to sense the position of the switches without looking at the panel.

FEATURES:

- Low zero resistance—less than 0.002 ohm per decade.
- High accuracy—0.05% for most decades.
- Low temperature coefficient of resistance.
- Negligible thermal emf to copper.
- Resistors are adjusted to specified values at their own terminals rather than at the box terminals, so that resistance *increments* are always correctly indicated.
- Residual reactances are small and are given in the specifications so that approximate frequency characteristics can be computed.



SPECIFICATIONS

Frequency Characteristics: Similar to those of individual TYPE 510 Decade Resistance Units, modified by the increased series inductance, L_0 , and shunt capacitance, C , due to the wiring and the presence of more than one decade in the assembly. At total resistance settings of approximately 1000 ohms or less, the frequency characteristic of any of these decade resistors is substantially the same as those shown for the TYPE 510 Decade-Resistance Units in the plot on page 158. At higher settings, shunt capacitance becomes the controlling factor, and the effective value of this capacitance depends upon the settings of the individual decades. See *Residual Impedances* below, and Figure 3, page 154.

Residual Impedances:

Zero Resistance (R_0): Less than 0.002 ohms per dial at dc; 0.04 ohms per dial at 1 Mc; proportional to square root of frequency at all frequencies above 100 kc.

Zero Inductance (L_0): 0.10 μ h per dial.

Effective Shunt Capacitance (C): This value is determined largely by the highest decade in use. With the LOW terminal connected to shield, a value of 15 to 10 μ f per decade may be assumed, counting decades down from the highest. Thus, if the third decade from the top is the highest resistance decade in circuit (i.e., not set at zero) the shunting terminal capacitance is 45 to 30 μ f. If the highest decade in the assembly is in use, the effective

capacitance is 15 to 10 μ f, regardless of the settings of the lower-resistance decades.

Temperature Coefficient of Resistance: Less than $\pm 0.002\%$ per degree Centigrade at room temperatures, except for the 0.1 Ω decade, where the box wiring will increase the overall temperature coefficient.

Type of Winding: See specifications for TYPE 510 Decade-Resistance Units, page 158.

Accuracy of Adjustment: All resistors are adjusted at dc within $\pm 0.05\%$ of the stated value at their terminals, except the 1-ohm units, which are adjusted within $\pm 0.15\%$, and the 0.1-ohm units, which are adjusted within $\pm 0.5\%$.

Maximum Current: See specifications for TYPE 510 Decade-Resistance Units, page 158. Values for 40° C rise are engraved on panels directly above switch knobs.

Terminals: Jack-top binding posts set on General Radio standard $\frac{3}{4}$ -inch spacing. Shield terminal is provided.

Mounting: Aluminum panel and cabinet.

Dimensions: Width, $4\frac{5}{16}$ inches; height, $4\frac{1}{16}$ inches; length, $10\frac{10}{16}$ inches for 3-dial, 13 inches for 4-dial, and $15\frac{3}{4}$ inches for 5-dial box.

Net Weight: TYPE 1432—A, C, F, 4 pounds, 2 ounces; TYPE 1432—J, K, L, Q, 5 pounds, 4 ounces; TYPE 1432—M, N, P, 6 pounds, 5 ounces.

Type	Resistance		No. of Dials	Type 510 Decades Used	Code Word	Price
1432-F	111 ohms, total, in steps of	0.1 ohm	3	A, B, C	DELTA	\$68.00
1432-K	1,111 ohms, total, in steps of	0.1 ohm	4	A, B, C, D	DEFER	92.00
1432-C	11,100 ohms, total, in steps of	10 ohms	3	C, D, E	DEBAR	78.00
1432-J	11,110 ohms, total, in steps of	1 ohm	4	B, C, D, E	DEBIT	100.00
1432-N	11,111 ohms, total, in steps of	0.1 ohm	5	A, B, C, D, E	DEMON	116.00
1432-L	111,100 ohms, total, in steps of	10 ohms	4	C, D, E, F	DECAY	106.00
1432-M	111,110 ohms, total, in steps of	1 ohm	5	B, C, D, E, F	DEMIT	128.00
1432-A	1,110,000 ohms, total, in steps of	1000 ohms	3	E, F, G	DEMUR	98.00
1432-Q	1,111,000 ohms, total, in steps of	100 ohms	4	D, E, F, G	DEPOT	121.00
1432-P	1,111,100 ohms, total, in steps of	10 ohms	5	C, D, E, F, G	DETER	143.00



Interior view of TYPE 1432-Q Decade Resistor.



TYPE 510 DECADE-RESISTANCE UNIT

USES: Because of their accuracy, compactness, and sturdy construction the TYPE 510 Decade-Resistance Units are ideal for assembly into production test instruments, bridges, and other experimental and permanent equipment. They are particularly useful in applications where only one or two decades are needed, or where a TYPE 1432 Decade Resistor cannot be mounted conveniently. In many cases the use of these units will release for general laboratory work relatively more expensive decade resistors, that would otherwise be tied up for long periods of time in experimental equipment.

DESCRIPTION: Winding methods are chosen to reduce the effects of residual reactances. The 1- and 10-ohm steps are Ayrton-Perry wound on molded phenolic forms especially shaped and heat treated to minimize aging effects. The 100-ohm steps are Ayrton-Perry wound on a form of silicone-fiberglass laminate. The 0.01- and 0.1-ohm steps are straight wire and hairpin-shaped ribbon, respectively, while the 1000-, 10,000-, and 100,000-ohm steps are unifilar wound on thin mica cards.

Each decade is enclosed in an aluminum shield, and a knob and etched-metal dial plate are supplied. The mechanical assembly is also available complete with shield, blank dial plate, switch stops, and knob, but without resistors, as the TYPE 510-P3 and -P3L Switches.

FEATURES:

➤ High accuracy — $\pm 0.05\%$ for most units.



- Excellent stability—newly developed stable resistance alloys, with final resistance adjustment after artificial aging at high temperatures above normal operating temperatures.
- Good frequency characteristics—most TYPE 510 Decades can be used at frequencies as high as several hundred kilocycles, as well as at dc.
- Low temperature coefficient.
- Negligible thermal emf to copper.
- Unaffected by high humidity—even the high resistance units can be exposed to high humidity for long periods of time without significant permanent change in resistance.

SPECIFICATIONS

Accuracy of Adjustment: Resistors are adjusted to be accurate at card terminals within the tolerances given in Table I.

Maximum Current: See Table I below. Maximum current is engraved on the dial plate supplied with each decade.

Frequency Characteristics: The equivalent circuit of a decade resistance unit is shown on page 154. The values of the residual impedances are listed in Table I.

The accompanying plot shows the maximum percentage change in effective series resistance of seven decades as a function of frequency. For TYPES 510-A and 510-B the error is due almost entirely to skin effect and is independent of switch setting. For TYPE 510-C the error changes slowly with dial setting and is a maximum at maximum resistance setting, while for TYPE 510-D a broad maximum occurs at the 600-ohm setting. For all the higher resistance units, the error is due almost entirely to the shunt capacitance and its losses and is approximately proportional to the square of the resistance setting.

The high-resistance decades (TYPES 510-E, 510-F, and 510-G) are very commonly used as parallel resistance

elements in resonant circuits, in which the shunt capacitance of the decades becomes part of the tuning capacitance. The parallel resistance changes by only a fraction, between a tenth and a hundredth, of the amount indicated in the plot as the series-resistance change, depending on frequency and the insulating material in the switch.

Switches: Quadruple-leaf brushes bear on lubricated contact studs $\frac{3}{8}$ inch in diameter. Both brushes and studs are of silver-bearing copper alloy. These brushes are bent so as not to be tangent to the arc of travel, thus avoiding cutting and affording a good wiping action. A cam-type detent is provided. There are eleven contact points (0 to 10 inclusive). The switch resistance is between 0.002 and 0.003 ohm. The effective capacitance of the switch is of the order of $5 \mu\text{mf}$, with a dissipation factor of 0.06 at 1 kc for the standard cellulose-filled molded phenolic switch form, and 0.01 for the mica-filled phenolic form used in the TYPE 510-G Unit.

Temperature Coefficient of Resistance: Less than $\pm 0.002\%$ per degree Centigrade at 23°C .

Terminals: Soldering lugs are provided.



Maximum percentage change in series resistance as a function of frequency for TYPE 510 Decade-Resistance Units.

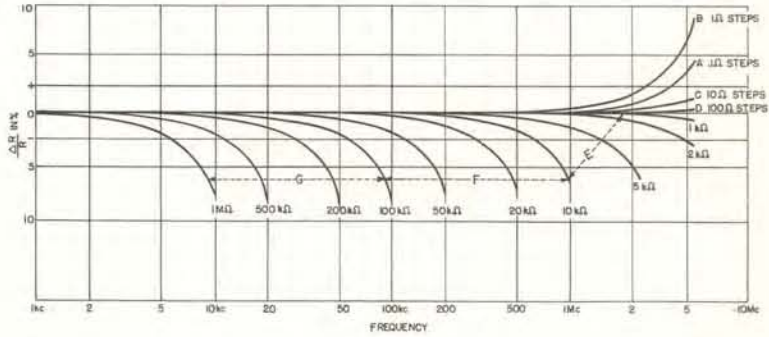

TABLE I

Type	Resistance per Step (ΔR) Ohms	Accuracy	Maximum Current $40^\circ C$ Rise	Power per Step watts	ΔL μh	C^* μf	L_0 μh
510-AA	0.01	$\pm 2\%$	4 a	.16	0.01	7.7-4.5	0.023
510-A	0.1	$\pm 0.5\%$	1.6 a	.25	0.014	7.7-4.5	0.023
510-B	1	$\pm 0.15\%$	800 ma	.6	0.056	7.7-4.5	0.023
510-C	10	$\pm 0.05\%$	250 ma	.6	0.11	7.7-4.5	0.023
510-D	100	$\pm 0.05\%$	80 ma	.6	0.29	7.7-4.5	0.023
510-E	1,000	$\pm 0.05\%$	23 ma	.5	3.3	7.7-4.5	0.023
510-F	10,000	$\pm 0.05\%$	7 ma	.5	9.5	7.7-4.5	0.023
510-G	100,000	$\pm 0.05\%$	2.3 ma	.5	—	7.7-4.5	0.023

*The larger capacitance occurs at the lowest setting of the decade. The values given are for units without the shield cans in place. With the shield cans in place, the shunt capacitance is from 10 to 20 μf greater than indicated here, depending on whether the shield is tied to the switch or to the zero end of the decade.

Mounting: Each decade is complete with dial plate and knob and can be mounted on any panel between $\frac{1}{4}$ inch and $\frac{3}{8}$ inch in thickness. A template is furnished with each unit. Thinner panels can be accommodated by the use of shorter mounting screws.

Dimensions: Over-all diameter, $3\frac{1}{16}$ inches; depth behind panel, $3\frac{3}{16}$ inches; template and dimension sketch mailed on request.

Net Weight: TYPE 510 Units, 11 ounces; TYPE 510-P3, $9\frac{1}{2}$ ounces.

Type	Resistance		Code Word	Price
	Total	Per Step		
510-AA	0.1 ohm	0.01 ohm	EASEL	\$19.50
510-A	1 ohm	0.1 ohm	ELATE	14.00
510-B	10 ohms	1 ohm	ELDER	20.00
510-C	100 ohms	10 ohms	ELEGY	20.00
510-D	1,000 ohms	100 ohms	ELBOW	21.00
510-E	10,000 ohms	1,000 ohms	ELECT	22.50
510-F	100,000 ohms	10,000 ohms	ELVAN	26.00
510-G	1,000,000 ohms	100,000 ohms	ENTER	35.00
510-R	100,000 ohms	Decade Steps, i.e., 0.1, 1, 10, 100, 1,000, 10,000, 100,000 ohms		
510-P3	Switch only (Black Phenolic Frame)		EAGER	27.00
510-P3L	Switch only (Low-Loss Phenolic Frame)		ENVOY	8.50
			ESTOP	9.50



Interior views of (left) TYPE 510-A, (center) TYPE 510-D, and (right) TYPE 510-E.





TYPE 1450 DECADIC ATTENUATOR

USES: The TYPE 1450 Decade Attenuator is useful in power-level measurements, transmission-efficiency tests, and in gain or loss measurements on transformers, filters, amplifiers and similar equipment. It can also be used as a power-level control in circuits not equipped with other volume controls.

DESCRIPTION: The resistors used in each decade are mounted in compartments in a cast aluminum housing, which is completely shielded by the addition of aluminum covers. Each decade consists of four T-pads series-connected by cam-operated switches, arranged with positive detents. All cams are mounted on a control shaft which is provided with ball bearings. Each pad is completely shielded, and a shield is interposed between the input and output elements of each pad. Each decade has eleven positions, 0 to 10 inclusive, so the decades overlap.

The assembly of decades is mounted in a cast aluminum cabinet.

FEATURES:

- Wide range of attenuation values in small steps.
- Accuracy is maintained even at low radio frequencies.
- Decade-type switches make the boxes convenient to use. There are no stops on the 0.1- and 1-db-per-step decades, facilitating quick return from full to zero attenuation when making adjustments. Switches are arranged for break-before-make operation to prevent "blasting" and meter damage. They can be adjusted for make-before-break operation if requested at time of ordering.
- An etched plate is attached to the case, indicating mismatch loss for terminations other than 600 ohms.

SPECIFICATIONS

Attenuation Range: 110 or 111 decibels in steps of 1 or 0.1 decibel, respectively.

Terminal Impedance: 600 ohms in either direction. An etched plate on the cabinet indicates the mismatch loss for other than 600-ohm circuits.

Accuracy: Each individual resistor is adjusted within $\pm 0.25\%$ of its correct value. The low-frequency error in attenuation is less than plus 0.004 db (TA), or 0.006 db (TB) $\pm 0.25\%$ of the indicated db value, provided the attenuator is terminated by a pure resistance of 600 ohms. When properly terminated, the input impedance is 600 ± 3 ohms.

Frequency Discrimination: Less than 0.1 db $\pm 1\%$ of the indicated value at frequencies below 200 kc.

Maximum Input Power: 1 watt.

Switches: Cam-type switches are used with twelve positions covering 360° . The dials are numbered from "0" to "10" inclusive and the twelfth point is also connected to "0". Stops are provided in the switch mechanism for

the 100-db decade. No stops are provided to prevent complete rotation of the 10- and 1-db decades, but spacers, which are provided, can be used under the mounting screws to act as stops for the knob.

Characteristic Impedance: 600 ohms both directions. Either end can be used as input.

Mounting: The decade units are mounted on an aluminum panel in a metal cabinet. Each decade is individually shielded, and all shields are connected to the panel and the "G" terminal. Relay-rack mounting is available on special order at an additional charge. See price list below.

Terminals: Jack-top binding posts with $\frac{3}{4}$ -inch spacing; common terminal of T units grounded to chassis; ground terminal provided.

Dimensions: 1450-TA, $10 \times 5\frac{3}{4} \times 12\frac{1}{4}$ inches, over-all; 1450-TB, $12 \times 5\frac{3}{4} \times 12\frac{1}{4}$ inches, over-all.

Net Weight: 1450-TA, $10\frac{3}{4}$ pounds; 1450-TB, $14\frac{1}{2}$ pounds.

Type	Range	Impedance	Type of Section	Code Word	Price
1450-TA	110 db in steps of 1 db	600 ohms	T	NETWORKTAM	\$240.00
1450-TB	111 db in steps of 0.1 db	600 ohms	T	NETWORKTUB	340.00

For 19-inch relay-rack mounting add \$10.00 to price and add R to type number (TYPE 1450-TAR, -TBR).



TYPE 1454 DECADE VOLTAGE DIVIDER



USES: The TYPE 1454 Decade Voltage Dividers provide accurately known voltage ratios for use in determining voltage transmission ratios by direct comparison or by null methods. It is particularly valuable in linearity measurements and meter calibration.

Their high input impedance, high resolution, and high accuracy make them widely used laboratory accessories for both d-c and audio-frequency measurements.

DESCRIPTION: The decade voltage division is accomplished by the use of the Kelvin-Varley circuit. Four resistor decades are connected

in such a manner that their settings are additive, while maintaining a constant input resistance.

FEATURES:

- High accuracy.
- Constant input resistance.
- Separate ground terminal provided.
- Voltage ratios between 1.0000 and .0001 in steps of .0001.
- Negligible thermal emf.
- Effect of switch contact resistance is balanced out.

SPECIFICATIONS

Voltage Ratio: .0001 to 1.0000 in steps of .0001.
Accuracy: $\pm 0.04\%$ of indicated ratio, for input voltages below 120. The voltage drop in switch contacts and wiring is balanced out so that full accuracy is maintained down to the lowest setting, 0.0001.
Linearity: $\pm 0.02\%$ of full scale setting.
Frequency Characteristics: If the external capacitance placed across the output terminals of TYPE 1454-A is less than 50 μf , the frequency error is less than 0.1% to 20 kc for any setting. For the TYPE 1454-AH, the frequency limit is 2 kc for the same capacitance.
Input Resistance: TYPE 1454-A, 10,000 ohms; TYPE 1454-AH, 100,000 ohms.
Output Resistance: Varies with output setting, depending primarily on the setting of the highest decade in use.
Maximum Input Voltage: 250 volts rms (or dc) for 40° C rise of the resistors of the input decade. Input voltage should be limited to 120 for maximum accuracy. At maximum rated voltage the total error can approach $\pm 0.1\%$.
Resistance Units: TYPE 510 (see page 157).
Temperature Coefficient: Of the individual resistors, less than $\pm 0.002\%$ per degree. Since the voltage ratios are determined by resistors of similar construction, ambient temperature effects are very small.
Terminals: Jack top binding posts with standard $\frac{3}{4}$ -inch spacing at input and output. A separate ground post is

provided, so that the divider circuit can be used grounded or ungrounded, with the shield grounded.
Mounting: Aluminum panel and cabinet.
Dimensions: (Length) $15\frac{3}{4}$ \times (width) $5\frac{1}{4}$ \times (height) 5 inches, over-all. **Net Weight:** $7\frac{1}{4}$ pounds.

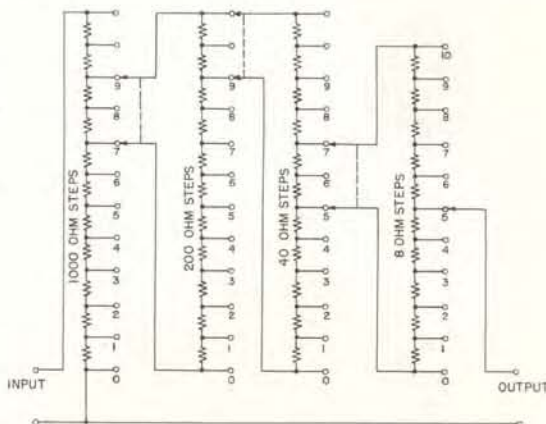

Type	Code Word	Price
1454-A	Decade Voltage Divider (10,000 ohms)	ABACK \$145.00
1454-AH	Decade Voltage Divider (100,000 ohms)	ABASH 145.00





TYPE 500 RESISTOR

The TYPE 500 Resistors are particularly recommended as resistance standards for use in impedance bridges and as secondary standards for laboratory use. The plug-type terminals make them readily interchangeable in experimental equipment. Screw terminals are also supplied for more permanent installations. Resistors are similar in construction to those used in TYPE 510 decades. (Page 157.)

This resistor is an accurately adjusted resistance unit wax-sealed in a phenolic case to exclude moisture and to provide protection from mechanical damage.

FEATURES:

- Convenient and accurate.
- Negligible thermal emf to copper.
- Low temperature coefficient of resistance.
- Excellent high-frequency characteristics.
- Standard plug-in terminals.



SPECIFICATIONS

Accuracy of Adjustment: $\pm 0.05\%$ at the terminals, except for the 1-ohm unit, which is adjusted within $\pm 0.15\%$.

Frequency Characteristics: Similar to those of the TYPE 510 Decade-Resistance Units for resistance values up to 600 ohms; somewhat better for higher resistances, because of the relatively small shunt capacitance of an isolated resistor.

Maximum Power and Current: All units will dissipate one watt for a temperature rise of 40° Centigrade. The value of current for this rise is given in the table below and is engraved on each unit.

Temperature Coefficient: Less than $\pm 0.002\%$ per degree Centigrade at normal room temperature.

Type of Winding: Less than 500 ohms, Ayrton-Perry; 500 ohms and higher, unifilar on thin mica cards. TYPES 500-V, W, and X are made up of multiple mica cards in series.

Terminals: Both terminal screws and plugs are supplied. Each terminal stud is recessed as a jack to accommodate a plug. Standard $\frac{3}{4}$ -inch spacing is used. High terminal is marked H.

Mounting: Black molded phenolic case is used for all units having a resistance of less than 1000 ohms. For units having a resistance value of 1000 ohms or higher, a low-loss mica-filled phenolic case is used. Both types are sealed with a high-melting point wax. TYPES 500-A through -V are in small case; TYPES 500-W and -X in large case.

Dimensions: Small case, (length) $2\frac{3}{4}$ \times (width) $1\frac{1}{16}$ inches. Two mounting holes, spaced $2\frac{1}{4}$ inches, No. 16 drill. Large case, (length) $3\frac{1}{16}$ \times (width) $2\frac{1}{8}$ inches. Two mounting holes, spaced $3\frac{1}{8}$ inches, No. 2 drill.

Net Weight: 2 ounces.

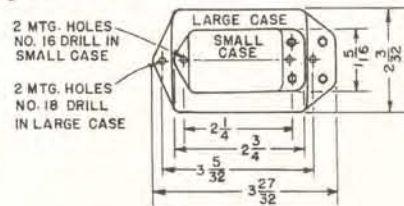

Type	Resistance in Ohms	Maximum Current	Code Word	Price
500-A	1	1.0 a	RESISTBIRD	\$ 5.50
500-B	10	310 ma	RESISTDESK	5.50
500-K	20	220 ma	RESISTFILM	5.50
500-C	50	140 ma	RESISTFORD	5.50
500-D	100	100 ma	RESISTFROG	5.50
500-E	200	70 ma	RESISTGIRL	5.50
500-F	500	45 ma	RESISTGOAT	5.50
500-G	600	40 ma	RESISTGOOD	5.50
500-H	1000	30 ma	RESISTHYMN	5.50
500-L	2000	22 ma	RESISTBELL	5.50
500-M	5000	14 ma	RESISTPIPE	5.50
500-J	10,000	10 ma	RESISTMILK	5.50
500-R	20,000	7 ma	RESISTBARN	5.50
500-T	50,000	4.5 ma	RESISTGULL	5.50
500-U	100,000	3 ma	RESISTROLL	5.50
500-V	200,000	2.2 ma	RESISTVOTE	7.50
500-W	500,000	1.4 ma	RESISTWALL	15.00
500-X	1 Megohm	1.0 ma	RESISTHULL	24.00

POTENTIOMETERS. General Radio 970-series potentiometers are listed on page 229.





STANDARD CAPACITORS

AIR-DIELECTRIC CAPACITORS Two-Terminal Types

The characteristics of a properly designed air capacitor approach very closely those of an ideal circuit element. Whether the capacitor is fixed or variable, a low temperature coefficient of capacitance, low losses, and a high degree of stability can be achieved.

For many measurements, and over a wide range of frequency, such a capacitor can be considered as having a terminal impedance defined solely by its electrostatic capacitance. However, for the most accurate measurements at audio frequencies or for measurements at radio frequencies, the small deviations from ideal performance must be examined and evaluated.

Figure 1 is a lumped constant equivalent circuit showing the residual parameters which cause the deviations from ideal performance. R represents the metallic resistance in the leads, stack supports and plates. L represents the series inductance of the structure and C the low frequency air dielectric capacitance. The capacitance C_0 represents the capacitance of the dielectric supporting structure. The conductance G represents (a) the dielectric losses in the supports, (b) the losses in the air dielectric and on the surface of the plates (significant only at very high humidities), and (c) the d-c leakage conductance.

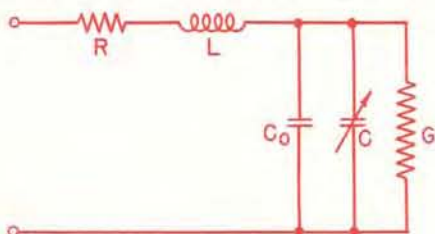

FIGURE 1. The equivalent circuit of a variable air capacitor.

At low frequencies the capacitance at the terminals is $C + C_0$ and only the component G need be considered in evaluating the dissipation factor. The effect of the leakage conductance is negligible at frequencies above a few cycles, and is ordinarily of importance only when the capacitor is used at dc, i.e., for charge storage. The losses in the air dielectric are negligible under conditions of moderate humidity and temperature.

At audio frequencies then, the dominant component of conductance is that contributed by dielectric losses in the insulating structure. Good quality, low-loss materials such as quartz, ceramics, and polystyrene used for supports in air capacitors are characterized by a dissipation factor that is nearly constant with frequency. This corresponds to a conductance component that varies approximately linearly with frequency.

The dissipation factor of the equivalent circuit, at low frequencies, can be written as

$$D = \frac{G}{\omega(C + C_0)} = \frac{D_0 C_0}{C + C_0}$$

D is thus inversely proportional to the terminal total capacitance, for a variable capacitor. The quantity

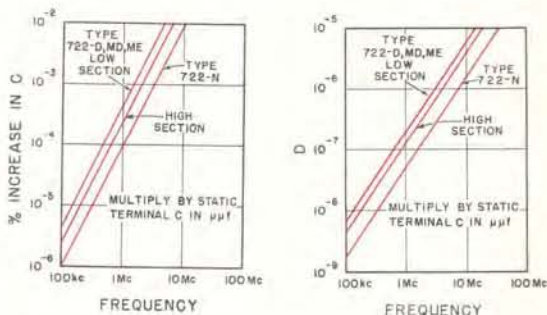

FIGURE 2. Variation of effective capacitance and D with frequency for TYPE 722 Precision Capacitors.

$D_0 C_0 = \frac{G}{\omega}$ is very nearly independent both of frequency and setting and as such is a convenient figure of merit for the capacitor. Since D_0 is dimensionless, $D_0 C_0$ can be expressed in $\mu\mu f$.

As frequency is progressively increased, the impedances of R and L become significant compared to the reactance of C and must be taken into account.

The resistance R ordinarily is not significant except at frequencies where skin effect is essentially complete, under which condition its value varies as the square root of frequency and may be expressed as $R_0 \sqrt{f}$, where R_0 is the resistance at one megacycle and f is the frequency in megacycles. The total dissipation factor of the capacitor when the resistance R is taken into account is

$$D = \frac{G}{\omega C} + R_0 \sqrt{f} \omega C \quad (2)$$

L represents the inductance of the current path between terminals. It is largely concentrated in the leads and supporting members, and, as a consequence, is nearly independent of setting in a variable capacitor. The variation in effective terminal capacitance caused by L is given by the expression

$$C_e = \frac{C}{1 - \omega^2 LC^2} \approx C + \omega^2 LC^2 \quad (3)$$

Variations of C_e and D for TYPE 722 Precision Capacitors are given in Figure 2 as a function of frequency, for various settings.

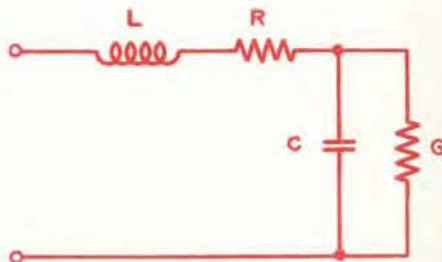

FIGURE 3. The equivalent circuit of a solid-dielectric capacitor.



► SOLID-DIELECTRIC CAPACITORS

A solid dielectric capacitor can be represented by the equivalent circuit of Figure 3, in which C is the electrostatic capacitance, and G is the parallel conductance. R is the equivalent series resistance, and L is the equivalent series inductance of the complete metallic structure including the leads.

The conductance G includes both the conductance due to dielectric losses and the d-c leakage conductance. The dissipation factor, D , which at low frequencies is determined mainly by G , at high frequencies is also dependent upon the series metallic resistance, R .

(Left) FIGURE 4. Capacitance versus frequency of a fixed solid-dielectric capacitor. (Right) FIGURE 5. Dissipation versus frequency of same capacitor.

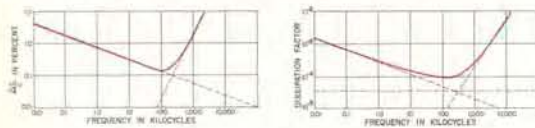

The series inductance, L , acts to increase the capacitance as the resonant frequency of the LC combination is approached. At low frequencies, principally below the audio range, the capacitance increases as a result of dielectric absorption caused by interfacial polarizations in the dielectric. Although these polarizations occur at frequencies of the order of 10^{-3} to 10^{-6} cycles per second, their effects are measurable in the working frequency range of the capacitor. The magnitude of the effect varies with the dielectric material.

Figure 4 shows the fractional change in capacitance as a function of frequency for a $0.001 \mu\text{f}$ mica dielectric capacitor. The dashed line slanting downward to the right is the capacitance characteristic resulting from interfacial polarization; that slanting upward to the right shows the effect of resonance with the effective series inductance, L , which causes the fractional change in capacitance to increase as the square of frequency. The solid curve is the sum of these two effects and is the over-all frequency characteristic.

The solid curve of Figure 5 shows the behavior of dissipation factor as a function of frequency for the same capacitor. Three components contribute to this characteristic: (1) a constant dissipation factor caused by a residual polarization shown by the horizontal dashed line, (2) the loss caused by interfacial polarizations, shown by the dashed line slanting downward to the right, and (3) ohmic loss in the leads and electrodes, which causes the dissipation factor to increase as the $\frac{3}{2}$ power of the frequency, shown by the dashed line slanting upward to the right. The d-c leakage conductance also contributes to the over-all dissipation factor, but for good dielectrics its effect is negligible in comparison with the other factors. If shown, it would be a line slanting downward to the right at 45° .

Fractional change in capacitance and absolute value of dissipation factor each have a minimum value, which occurs at a frequency that varies inversely with capacitance and that can be as low as 1 kc and as high as 1 Mc for capacitance values in the range from $1 \mu\text{f}$ to $100 \mu\text{f}$.

In the following pages are described fixed, solid-dielectric capacitors of various materials assembled in decade combinations. The TYPE 1419-K Decade Capacitor and the TYPES 980-F, -G, and -H Decade Capacitor Units use TYPE 505 Capacitors with silvered mica as the dielectric material. High-dielectric strength, low dielectric loss, and high dimensional stability make high-quality mica the best

available solid dielectric for alternating-current standard capacitors. Silvered mica sheets with soft metallic foil interposed between sheets insure intimate and stable contact between electrodes and the dielectric, as well as low series resistance.

For use at d-c or extremely low frequencies, mica dielectric is at some disadvantage because of the relatively large increase in capacitance over the audio-frequency value. This increase is caused by interfacial polarizations having extremely long relaxation times.

Polystyrene exhibits the desirable property of having dielectric constant and dissipation factor very nearly invariant with frequency, the total increase in d-c dielectric constant over the audio-frequency value being only a small fraction of a percent (in contrast, mica may exhibit a rise of the order of 3%). The TYPE 1419-A Decade Capacitor and the TYPE 980-A, -B, -C and -D Decade Capacitor Units use hermetically sealed capacitors, wound and connected non-inductively, with carefully processed polystyrene film.

The TYPE 980-M and -N Decade Capacitors use molded silvered-mica capacitors, and the TYPE 980-L has paper dielectric. These three decades, assembled into a single cabinet, form the TYPE 219-M Decade Capacitor. While not as accurate in calibration, nor as low in dissipation factor as the all-mica and the polystyrene units, this decade has many uses in the electronics laboratory.

When capacitors are assembled into decades, as in the TYPE 980 Decade Capacitor Units, the residual impedances are increased by the switch and wiring. The assembling of several decades into a TYPE 219 or 1419 Decade Capacitor adds more series residuals and more terminal capacitance.

► THREE-TERMINAL CAPACITORS

Any physically realizable capacitor is composed of at least three separate capacitances, which form a closed loop, or delta. In addition to the main, direct capacitance, connected between two terminals, each terminal has a capacitance (called terminal capacitance) to surrounding objects, such as shield, case, or ground. In the 2-terminal capacitor, one of the terminals is grounded to case, or shield, which puts the other terminal capacitance across the direct capacitance. The calibrated value of a 2-terminal capacitor includes therefore, the sum of the two.

FIGURE 6. Schematic representation of a 3-terminal capacitor.

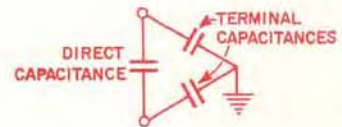

There are, however, many measurements where it is desirable to have a 3-terminal Standard. An obvious advantage is the relative freedom from the effects of capacitance from the connecting leads to ground, which cannot affect the direct capacitance. The capacitance between leads can be eliminated by shielding.

Losses are lower in 3-terminal air capacitors than in 2-terminal, because the dielectric losses appear in the terminal-to-ground capacitances.

For standards whose capacitance is a fraction of a micromicrofarad, the 3-terminal arrangement is the best practical construction.

Three models of TYPE 722 Precision Capacitors are available with 3-terminal construction; and accuracy specifications for fixed, solid-dielectric, and decade capacitors are given for both methods of connection.

TYPE 722 PRECISION CAPACITOR



TYPE 722-D



TYPE 722-CB

USES: The TYPE 722 Precision Capacitor is a stable and precise variable air capacitor intended for use as a standard of capacitance.

It is widely used in ac bridges, both as built-in standard and as an external standard for substitution measurements. It is also used as a tuning capacitor in oscillators and frequency meters, and as a standard in electronic gauges, calibrators and other instruments. Where highest accuracy and stability are important, it is the standard of the industry.

Both 2-terminal and 3-terminal models are available.

DESCRIPTION: The capacitor assembly is mounted in a cast frame, which gives the unit rigidity. The frame, spacers, stator rods, and rotor shaft are made of the best available alloys of aluminum, which combine the high mechanical strength of brass with the low weight of aluminum. The plates are also of aluminum, so that all parts have the same temperature coefficient of linear expansion.

A worm drive is used to obtain the desired high precision of setting. In order to avoid the slight eccentricity that may occur when a worm gear is mounted on a shaft, the shaft and the worm are accurately machined as one piece. The dial end of this worm shaft runs in a self-aligning ball bearing, while the other end is supported by an adjustable spring mounting. Sealed, self-lubricating ball bearings, lightly stressed, are used at the ends of the rotor shaft. Electrical connection to the

rotor is made by means of a silver alloy brush bearing on a silver overlay drum to assure a positive electrical contact.

The preliminary assembly of the frame, shaft, and gears is motor driven to grind in the gears before final assembly to improve smoothness and concentricity.

TYPE 722-N is intended for use at high frequencies and has connection made at the centers of both stator and rotor stacks to minimize residual inductance and resistance.

Two of the three-terminal models, TYPES 722-CC and -CD, differ radically from conventional construction. Two sets of stator plates are interleaved and insulated from each other and from ground. The capacitance between these two stator stacks is varied by a set of grounded rotor plates, with annular windows, interposed between the stators. The direct capacitance between stator stacks is directly proportional to the area exposed through the annular opening and, hence, to the angle of rotation of the rotor. This construction yields extremely low losses and a high degree of linearity.

FEATURES:

- High stability.
- High precision of setting—one part in 25,000 of full scale; scale length is 20 feet.
- High accuracy.
- Low backlash.
- Low temperature coefficient of capacitance.
- Low dielectric losses.



SPECIFICATIONS

Types Available:

722-D; two section, direct reading in total capacitance.
722-N; single section, direct reading in total capacitance; for use at radio frequencies.

722-MD and -ME; two section, direct reading in

capacitance removed; for use in substitution measurements.
722-CB and -CC; single section, three-terminal construction direct reading in total capacitance.

722-CD; two section three-terminal construction, direct reading in total capacitance.

Type	Capacitance Range, μf	Direct-Reading Accuracy	Approx. Cap. at Zero Scale Setting	Terminals	Series Inductance μh	Series Resistance in ohms at 1 Mc	Dielectric Losses,	
							D_0 Steatite	C_0 Quartz
722-D	100 to 1150	$\pm 0.1\%$ or $\pm 1 \mu\text{f}^*$	1140 μf	2	0.06	.02	$.03 \times 10^{-12}$	$.003 \times 10^{-12}$
	25 to 115	$\pm 0.1\%$ or $\pm 0.2 \mu\text{f}^*$						
722-MD	0 to 1050	$\pm 0.1\%$ or $\pm 1 \mu\text{f}^*$	135	2	0.06	.02	$.03 \times 10^{-12}$	$.003 \times 10^{-12}$
	0 to 105	$\pm 0.1\%$ or $\pm 0.2 \mu\text{f}^*$						
722-ME	0 to 105	$\pm 0.1\%$ or $\pm 0.2 \mu\text{f}^*$	145	2	0.06	.02	$.03 \times 10^{-12}$	$.003 \times 10^{-12}$
	0 to 10.5	$\pm 0.1\%$ or $\pm 0.05 \mu\text{f}^*$						
722-N	100 to 1150	$\pm 0.1\%$ or $\pm 1 \mu\text{f}$		2	0.024	.008	$.04 \times 10^{-12}$	$.004 \times 10^{-12}$
722-CB	50 to 1100	$\pm 0.1\%$ or $\pm 1 \mu\text{f}$		3			Not applicable. Dissipation Factor not greater than	
722-CC†	5 to 110	$\pm 0.1\%$ or $\pm 0.2 \mu\text{f}$	0	3			50 $\times 10^{-6}$ for -CB, 10 $\times 10^{-6}$ for -CC, -CD.	
722-CD†	0.5 to 11 0.05 to 1.1	$\pm 0.1\%$ or $\pm 0.04 \mu\text{f}$ $\pm 0.008 \mu\text{f}$	0	3				

* Whichever is greater.

† These models have brass plates.

Overall Usable Accuracy: The accuracies stated above can be attained for the 722-D and 722-N in practice only if an acceptable standard technique is used by the operator to connect the capacitor into a measuring circuit. Otherwise, the usable accuracy at the capacitor terminals may

be limited to approximately $\pm 1 \mu\text{f}$.

Correction Chart: A correction chart is supplied giving corrections at multiples of 1, 10 or 100 μf , depending on the total capacitance of the capacitor. Accuracies obtainable through the use of these charts are as follows:

Type	Range, μf	Accuracy after correction is applied	
		Total Capacitance	Capacitance Differences
722-D	{ 100 to 1150 25 to 115	$\pm 0.1\%$ or $\pm 0.4 \mu\text{f}^*$	$\pm 0.1\%$ or $\pm 0.8 \mu\text{f}^*$
		$\pm 0.1\%$ or $\pm 0.08 \mu\text{f}^*$	$\pm 0.1\%$ or $\pm 0.16 \mu\text{f}^*$
722-MD	{ 0 to 1050 0 to 105	$\pm 0.1\%$ or $\pm 0.4 \mu\text{f}^*$	$\pm 0.1\%$ or $\pm 0.8 \mu\text{f}^*$
		$\pm 0.1\%$ or $\pm 0.08 \mu\text{f}^*$	$\pm 0.1\%$ or $\pm 0.16 \mu\text{f}^*$
722-ME	{ 0 to 105 0 to 10.5	$\pm 0.1\%$ or $\pm 0.08 \mu\text{f}^*$	$\pm 0.1\%$ or $\pm 0.16 \mu\text{f}^*$
		$\pm 0.1\%$ or $\pm 0.02 \mu\text{f}^*$	$\pm 0.1\%$ or $\pm 0.04 \mu\text{f}^*$
722-N	100 to 1150	$\pm 0.1\%$ or $\pm 0.4 \mu\text{f}^*$	$\pm 0.1\%$ or $\pm 0.8 \mu\text{f}^*$
722-CB	50 to 1100	$\pm 0.1\%$ or $\pm 0.4 \mu\text{f}^*$	$\pm 0.1\%$ or $\pm 0.8 \mu\text{f}^*$
722-CC	5 to 110	$\pm 0.1\%$ or $\pm 0.08 \mu\text{f}^*$	$\pm 0.1\%$ or $\pm 0.16 \mu\text{f}^*$
722-CD	{ 0.5 to 11 0.05 to 1.1	$\pm 0.1\%$ or $\pm 0.02 \mu\text{f}^*$	$\pm 0.1\%$ or $\pm 0.04 \mu\text{f}^*$
		$\pm 0.1\%$ or $\pm 0.003 \mu\text{f}^*$	$\pm 0.1\%$ or $\pm 0.006 \mu\text{f}^*$

† When differences are taken from any zero worm-dial setting.

* Whichever is greater.

Worm Correction Calibration: Corrections for the slight residual eccentricity of the worm drive can be supplied for all models at an extra charge indicated in the price

list. Mounted charts are supplied, which give the corrections to at least one more figure than the guaranteed accuracies, which are stated below.

Type	Range, μf	Accuracy after worm correction is applied	
		Total Capacitance	Capacitance Differences
722-D	{ 100 to 1150 25 to 115	$\pm 0.1\%$ or $\pm 0.1 \mu\text{f}^*$	$\pm 0.1\%$ or $\pm 0.2 \mu\text{f}^*$
		$\pm 0.1\%$ or $\pm 0.02 \mu\text{f}^*$	$\pm 0.1\%$ or $\pm 0.04 \mu\text{f}^*$
722-MD	{ 0 to 1050 0 to 105	$\pm 0.1\%$ or $\pm 0.1 \mu\text{f}^*$	$\pm 0.1\%$ or $\pm 0.2 \mu\text{f}^*$
		$\pm 0.1\%$ or $\pm 0.02 \mu\text{f}^*$	$\pm 0.1\%$ or $\pm 0.04 \mu\text{f}^*$
722-ME	{ 0 to 105 0 to 10.5	$\pm 0.1\%$ or $\pm 0.02 \mu\text{f}^*$	$\pm 0.1\%$ or $\pm 0.04 \mu\text{f}^*$
		$\pm 0.1\%$ or $\pm 0.004 \mu\text{f}^*$	$\pm 0.1\%$ or $\pm 0.008 \mu\text{f}^*$
722-N	100 to 1150	$\pm 0.1\%$ or $\pm 0.1 \mu\text{f}^*$	$\pm 0.1\%$ or $\pm 0.2 \mu\text{f}^*$
722-CB	50 to 1100	$\pm 0.1\%$ or $\pm 0.1 \mu\text{f}^*$	$\pm 0.1\%$ or $\pm 0.2 \mu\text{f}^*$
722-CC	5 to 110	$\pm 0.1\%$ or $\pm 0.02 \mu\text{f}^*$	$\pm 0.1\%$ or $\pm 0.04 \mu\text{f}^*$
722-CD	{ 0.5 to 11 0.05 to 1.1	$\pm 0.1\%$ or $\pm 0.004 \mu\text{f}^*$	$\pm 0.1\%$ or $\pm 0.008 \mu\text{f}^*$
		$\pm 0.1\%$ or $\pm 0.001 \mu\text{f}^*$	$\pm 0.1\%$ or $\pm 0.002 \mu\text{f}^*$

† When differences are taken from any zero worm-dial setting.

* Whichever is greater.





Maximum Voltage: All models, 1000 volts, peak.
Dielectric Supports: Low loss steatite and polystyrene. Quartz bars, treated to prevent formation of water films, can be supplied instead of steatite on special order (see price list).
Insulation Resistance: Under standard conditions (23° C, 50% RH) greater than 10¹² ohms.
Residual Parameters: The series resistance varies as the square root of the frequency above 100 kc. Its effect is negligible below this frequency.
Frequency Characteristic: See Figure 2, page 162, for plot of variation of capacitance with frequency.
Temperature Coefficient of Capacitance: Approximately +0.002% per degree Centigrade, for small temperature changes.

Backlash: Less than one-half division, corresponding to 0.01% of full scale value. If the desired setting is always approached in the direction of increasing scale reading, no error from this cause will result.
Terminals: Jack-top binding posts are provided on 2-terminal models; Standard 3/4-inch spacing is used. The rotor terminal is connected to the panel and shield. TYPE 874 Coaxial Connectors are used on 3-terminal models.
Accessories Supplied: 2 TYPE 874-C58 Cable Connectors with all 3-terminal models.
Mounting: The capacitor is mounted on an aluminum panel finished in crackle and enclosed in a shielded hardwood cabinet. A wooden storage case with carrying handle is supplied (weight 9 1/4 pounds).
Dimensions: Panel, 8 x 9 1/8 inches; depth, 8 1/8 inches.

Type		Net Weight	Code Word	Price
722-D	Precision Capacitor.....	10 1/2 pounds	CRUEL	\$235.00
722-MD	Precision Capacitor.....	10 1/2 pounds	CYNIC	225.00
722-ME	Precision Capacitor.....	10 1/2 pounds	COUPE	225.00
722-N	Precision Capacitor.....	11 1/4 pounds	BOXER	210.00
722-CB	Precision Capacitor.....	9 1/2 pounds	CARON	205.00
722-CC	Precision Capacitor.....	12 3/4 pounds	CHAOS	265.00
722-CD	Precision Capacitor.....	10 1/2 pounds	COFIN	265.00

WORM-CORRECTION CALIBRATION

Capacitor Type		Code Word*	Price
722-D	Worm Correction	WORMY	\$ 90.00
722-MD	Worm Correction	WORMY	90.00
722-ME	Worm Correction	WORMY	110.00
722-N	Worm Correction	WORMY	50.00
722-CB	Worm Correction	WORMY	55.00
722-CC	Worm Correction	WORMY	55.00
722-CD	Worm Correction	WORMY	165.00

*When ordering capacitor with worm correction, use compound code word, CRUELWORMY, CYNICWORMY, etc.

QUARTZ INSULATION

The following TYPE 722 Precision Capacitors can be obtained with quartz insulation.

Type		Code Word	Price
722-DQ	TYPE 722-D with Quartz Insulators.....	CRUELQUATZ	\$330.00
722-MDQ	TYPE 722-MD with Quartz Insulators.....	CYNICQUATZ	315.00
722-MEQ	TYPE 722-ME with Quartz Insulators.....	COUPEQUATZ	320.00
722-NQ	TYPE 722-N with Quartz Insulators.....	BOXERQUATZ	290.00

TYPE 722-CC



TYPE 722-CD



TYPE 722-ME





STANDARD AIR CAPACITORS

These fixed, air-dielectric capacitance standards supplement the TYPE 1409 fixed mica standards, providing stable, low-loss standards of measurement in low-capacitance values.

TYPE 1401 STANDARD AIR CAPACITOR (TWO TERMINAL)

The two-terminal TYPE 1401 units consist of plate assemblies supported by a quartz insulating plate, attached to an aluminum casting. With the cylindrical aluminum case, this arrangement provides a dust-free enclosure and a complete electrostatic shield. All plates, rods, and spacers are aluminum to minimize thermal stresses.



TYPE 1401



TYPE 1403

SPECIFICATIONS

Terminals: TYPE 274 Plugs spaced $\frac{3}{4}$ inch on centers. These will plug into a pair of jack-top binding posts, such as the TYPE 938. The calibrated capacitance is the "insertion" capacitance added to a circuit when the capacitor is thus connected.

Calibration: A certificate of calibration is supplied with each unit, giving the individually measured capacitance to an accuracy of 0.1%.

Dimensions: $\frac{3}{4}$ (dia.) by $4\frac{1}{4}$ inches, over-all.

Net Weight: One pound, 2 ounces.

Type	Insertion Capacitance	Adjustment Accuracy	Max. Volts	Dissipation Factor	Code Word	Price
1401-A	100 μf	0.2%	1500	100×10^{-6}	HABIT	\$45.00
1401-B	200 μf	0.15%	1200	50×10^{-6}	HONOR	46.00
1401-C	500 μf	0.12%	900	20×10^{-6}	HOLLY	48.00
1401-D	1000 μf	0.1%	700	10×10^{-6}	HANDY	53.00

TYPE 1403 STANDARD AIR CAPACITORS (THREE TERMINAL)

The TYPE 1403 units are three-terminal capacitors. The three largest sizes are similar in construction to the TYPE 1401, except that neither terminal is grounded to the case. The smaller capacitance units are made up of two

plates with a grounded plate between them; an aperture in the grounded plate determines the magnitude of the direct capacitance. Dielectric losses are not detectable; there is no solid dielectric in the direct-capacitance field.

SPECIFICATIONS

Terminals: TYPE 874 Coaxial Connectors for complete shielding of leads.

Accessories Supplied: Two TYPE 874-C58 Cable Connectors.

Calibration: A certificate of calibration is supplied with

each unit, giving the individually measured capacitance to an accuracy of 0.1%.

Dimensions: Identical with those of TYPE 1401 (above).

Net Weight: One pound.

Type	Direct Capacitance	Adjustment Accuracy	Max. Volts	Dissipation Factor	Code Word	Price
1403-A	1000 μf	0.1%	700	10×10^{-6}	DABBY	\$60.00
1403-D	100 μf	0.1%	1500	10×10^{-6}	DAIRY	55.00
1403-G	10 μf	0.1%	1500	10×10^{-6}	DASHY	48.00
1403-K	1.0 μf	0.1%	1500	10×10^{-6}	DATUM	45.00
1403-N	0.1 μf	0.1%	1500	10×10^{-6}	DAUNT	45.00
1403-R	0.01 μf	0.3%	1500	10×10^{-6}	DAVIT	45.00





TYPE 505 CAPACITOR



The TYPE 505 Capacitors are used as secondary laboratory standards and as high-quality circuit elements.

The capacitor unit consists of a silvered-mica and foil pile, which is spring-held by a

heavy metal clamp for mechanical rigidity. This clamp is not connected to either capacitor terminal but is left floating. Both outside foils are connected together. After aging, the capacitor unit is placed in the low-loss phenolic case, with silica gel to provide continuous desiccation, with ground cork to absorb shock, and then sealed with wax.

FEATURES:

- Small, convenient, and accurate.
- Has both screw- and plug-type terminals.
- Low temperature coefficient of capacitance.
- Low-loss case to reduce dielectric loss and leakage conductance.

SPECIFICATIONS

Accuracy: $\pm 0.5\%$ or $\pm 3 \mu\text{f}$, whichever is the larger.
Temperature Coefficient: Approximately $+0.0035\%$ per degree Centigrade between 10° and 50° Centigrade. Calibration is made at 23°C. , at a frequency of 1 kc.
Dissipation Factor: 0.0003 for $1000 \mu\text{f}$ and higher; $500 \mu\text{f}$, 0.00035; $200 \mu\text{f}$, 0.0004; $100 \mu\text{f}$, 0.0006.

Frequency Characteristics: See plots below. Series inductance is approximately $0.055 \mu\text{h}$ for units in small case and $0.085 \mu\text{h}$ for large case. Series resistance at 1 Mc is approximately 0.03 ohm for small case and 0.05 ohm for large case, varying as square root of frequency above 100 kc.

Leakage Resistance: Greater than 100,000 megohms, when measured at 500 volts, except for the TYPES 505-U and 505-X, for which it is greater than 50,000 and 20,000 megohms, respectively.

Maximum Voltage: See table. At higher frequencies the allowable voltage decreases and is inversely proportional to the square root of the frequency. These limits corre-

spond to a temperature rise of 40° Centigrade for a power dissipation of 1 watt for the small case and 2.5 watts for the large case.

Terminals: Screw terminals spaced $\frac{3}{4}$ inch apart. Two TYPE 274-P Plugs are supplied with each capacitor. High terminal (inside foil) is marked H.

Mounting: Mica-filled, low-loss phenolic cases.

Dimensions: See sketch. Over-all height, $1\frac{5}{8}$ inches for large case, 1 inch for small case, exclusive of plugs.

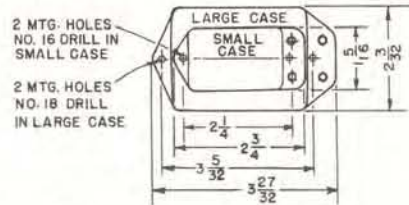

Type	Capacitance	Maximum Peak Volts	Frequency Limit for Max. Volts	Weight in Ounces	Code Word	Price
505-A	100 μf	700	2000kc	4	CONDENALLY	\$ 8.00
505-B	200 μf	700	1000	4	CONDENBELL	6.50
505-E	500 μf	500	1000	4	CONDENCOAT	6.00
505-F	0.001 μf	500	800	4	CONDENDRAM	6.00
505-G	0.002 μf	500	400	5	CONDENEYRE	6.50
505-K	0.005 μf	500	160	5	CONDENFACT	6.50
505-L	0.01 μf	500	80	5	CONDENGIRL	8.50
505-M	0.02 μf	500	40	6	CONDENHEAD	10.00
* 505-R	0.05 μf	500	40	11	CONDENCALM	13.50
* 505-T	0.1 μf	500	20	12	CONDENCROW	18.50
* 505-U	0.2 μf	500	10	13	CONDENWIPE	26.00
* 505-X	0.5 μf	500	4	15	CONDENWILT	55.00

* Mounted in large case.

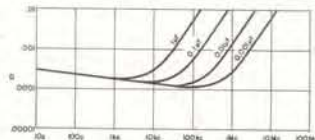
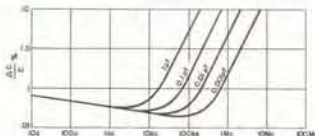

(Left) Change in capacitance as a function of frequency for TYPE 505 Capacitors. These changes are referred to the values which the capacitors would have if there were neither interfacial polarization nor series inductance. Since the capacitors are adjusted to their nominal values at 1 kc, the 1-kc value on the plot should be used as a basis of reference in estimating frequency errors. (Right) Dissipation factor as a function of frequency.





TYPE 1409 STANDARD CAPACITOR

USES: These capacitors are fixed standards for laboratory use. When they are used in conjunction with a TYPE 722-D or a TYPE 722-M Precision Capacitor in a parallel substitution method of measurement, precise measurements of capacitance up to several microfarads can be made. For the capacitance standardization laboratory, a set of TYPE 1409 Standard Capacitors, used with a TYPE 716-C Capacitance Bridge, is recommended.

DESCRIPTION: The TYPE 1409 Standard Capacitor uses a silvered mica and foil stack similar to that used in the TYPE 505; units are selected for low dissipation factor and are put through an additional aging process. The final accuracy and stability are thus exceptionally good. The units are mounted in cast aluminum cases, with silica gel to provide continuous desiccation, and are sealed with high-temperature potting wax. Jack-top binding posts including a ground terminal are provided.

A group of these capacitors observed over a 4-year period have shown random fluctuations of only $\pm 0.01\%$ in measured capacitance with



no evidence of systematic drift. This is an improvement of at least one order of magnitude over previous designs.

FEATURES:

- Stable within $\pm 0.01\%$.
- Calibrated for both 2-terminal and 3-terminal connections.
- Plug-in terminals permit several units to be stacked one upon the other without the use of leads and without cumulative error.

SPECIFICATIONS

Accuracy of Adjustment: Within $\pm 0.05\%$ of the nominal capacitance value marked on the case.

Calibration: Measured values of capacitance for both the two-terminal and the three-terminal connections at a specified room temperature are entered in the calibration certificate. These values are obtained by direct comparison, to a precision of better than 0.01% , with a like standard periodically certified by the National Bureau of Standards to an accuracy of $\pm 0.03\%$ in absolute capacitance.

Temperature Coefficient of Capacitance: $+ 35 \pm 10$ ppm per degree Centigrade between 10° and 70° C.

Dissipation Factor: Less than 0.0003 at 1 kc and 23° C. See curves on preceding page.

Frequency Characteristics: See curves on preceding page. Values of series inductance and series resistance at 1 Mc

are given in the table below. This resistance varies as the square root of the frequency for frequencies above 100 kc.

Leakage Resistance: 5,000 megohm-microfarads or 100,000 megohms, whichever is the lesser.

Maximum Voltage: 500 volts peak at frequencies below the limiting frequencies tabulated below. At higher frequencies the allowable voltage decreases and is inversely proportional to the frequency, approximately. These limits correspond to a temperature rise of 40° Centigrade for a power dissipation of 5, 6, and 7.5 watts respectively, for the three case sizes.

Mounting: Cast aluminum cases with rubber feet.

Terminals: Two insulated jack-top terminals, plus jack-top terminal and ground strap.

Dimensions: Small case, $3\frac{1}{4} \times 4 \times 2$ inches; medium case, $3\frac{1}{4} \times 4 \times 2\frac{1}{16}$ inches; large case, $3\frac{1}{4} \times 5\frac{5}{8} \times 2\frac{1}{16}$ inches.

Type	Capacitance in μf	Maximum Peak Volts	Frequency Limit for Max. Volts	Series Inductance in μh	Resistance in Ohms at 1 Mc	Weight in Pounds	Code Word	Price
1409-F	0.001	500	4.0 Mc	0.050	0.02	$1\frac{1}{4}$	GOODCONBOY	\$ 32.00
1409-G	0.002	500	2.3 Mc	0.050	0.02	$1\frac{1}{4}$	GOODCONBUG	32.00
1409-K	0.005	500	1.1 Mc	0.050	0.02	$1\frac{1}{4}$	GOODCONCAT	34.00
1409-L	0.01	500	640 Kc	0.050	0.02	$1\frac{1}{4}$	GOODCONDGG	34.00
1409-M	0.02	500	370 Kc	0.050	0.02	$1\frac{1}{4}$	GOODCONEYE	36.00
1409-R	0.05	500	175 Kc	0.055	0.02	$1\frac{1}{4}$	GOODCONPIG	39.00
1409-T	0.1	500	100 Kc	0.055	0.02	$1\frac{1}{4}$	GOODCONROD	42.00
1409-U	0.2	500	50 Kc	0.055	0.02	$1\frac{1}{4}$	GOODCONSIN	50.00
1409-X*	0.5	500	20 Kc	0.055	0.02	$1\frac{3}{4}$	GOODCONSUM	80.00
1409-Y†	1.0	500	10 Kc	0.070	0.03	$2\frac{1}{2}$	GOODCONTOP	130.00

*Mounted in medium case.

†Mounted in large case.



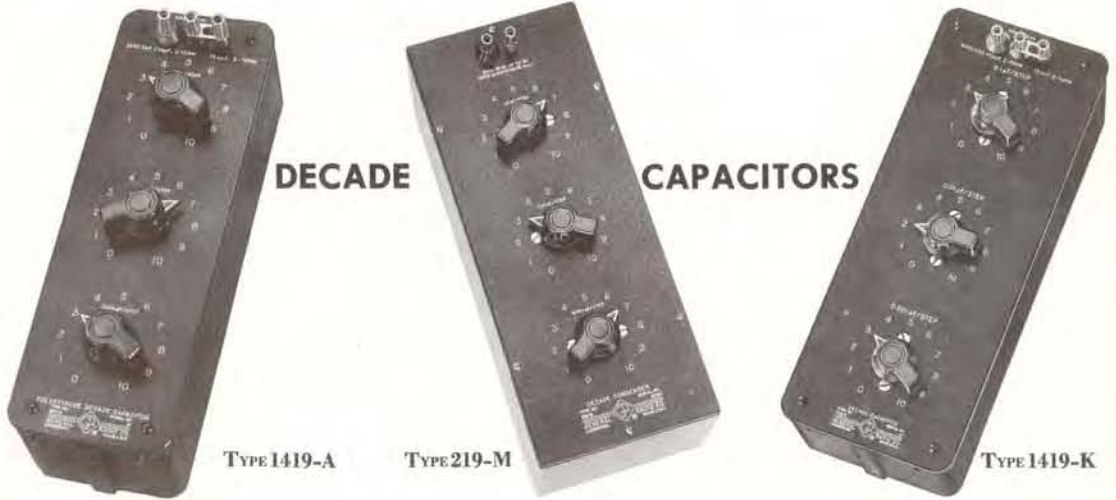

General Radio Decade Capacitors are assemblies of three TYPE 980 Decade Capacitors in shielded cabinets. All models have a multiplicity of uses in the electronics laboratory, as circuit elements in resonant circuits, bridges, filters, and experimental equipment. Each individual model has also its own specialized applications, by virtue of its design and construction features. Each model is described below with complete specifications.

TYPE 1419-A POLYSTYRENE DECADE CAPACITOR

USES: Owing to its very low dielectric absorption, the TYPE 1419-A Polystyrene Decade Capacitor is particularly useful in research and development work on computer and integrator circuits and on low-level amplifiers. Its constancy of capacitance and dissipation factor as a function of frequency also makes it extremely useful in measurement circuits and as a component in filters and tuned circuits. High insulation resistance and low dielectric absorption make it a nearly ideal capacitor for d-c work.

DESCRIPTION: This decade capacitor is based on development work and manufacturing experience at General Radio since 1940. The individual capacitor units, TYPES 980-A, -B, and -C, are designed to be essentially non-inductive and are heat-stabilized, so that their long-time stability approaches that of the best silvered-mica capacitors.

The capacitors are wound in spool form from continuous interleaved tapes of polystyrene and metal foil. The foils projecting at each end of the roll are soldered together to minimize

inductance and series resistance.

The tape used for the dielectric is specially prepared of purified high-molecular-weight polystyrene, having very high resistance and freedom from polarization. Hermetic sealing with Teflon feed-through insulators assures high performance even under adverse humidity conditions.

Terminals are provided for both 2-terminal and 3-terminal connections.

FEATURES:

- High insulation resistance.
- Low dielectric absorption.
- Low dielectric loss.
- Capacitance and dissipation factor vary only slightly with frequency from dc through the audio frequency range.
- Completely shielded and hermetically sealed.
- All insulation of highest available quality.
- Three-terminal construction.

TYPE 1419-K DECADE CAPACITOR

USES: This high-quality decade capacitor finds uses in every laboratory: in tuned circuits, impedance bridges, filters, or in any circuit where an accurate and stable variable capacitor is necessary.

Mica dielectric is used throughout, which permits operation at higher temperatures than do polystyrene types.

DESCRIPTION: The TYPE 1419-K Decade Capacitor is an assembly of TYPE 980-F, -G, and -H Decade Capacitor Units mounted in a shielded cabinet. The individual capacitors are General Radio TYPE 505 units, which are





assembled from selected sheets of silvered mica.

FEATURES:

- High stability.
- 0.5% accuracy.
- Low temperature coefficient.
- 3-Terminal construction.
- Low dissipation factor.
- Shielded case.

TYPE 219-M DECADE CONDENSER

USES: The TYPE 219-M Decade Condenser is a general purpose capacitor adjustable in

0.001- μ f steps up to 1.110 μ f. In experimental circuits where dissipation factor is not critical it offers excellent performance at moderate cost. It is designed for two-terminal use only.

DESCRIPTION: The capacitor decades used in this box are TYPES 980-L, -M, and -N. The TYPES 980-M and 980-N use molded, characteristic-C, silvered-mica capacitors. The highest capacitance decade, TYPE 980-L, uses stabilized paper-dielectric units. These are wound in spool form in the same manner as the polystyrene units of the TYPE 1419-A and, in addition, are impregnated with microcrystalline wax, which provides an effective seal against moisture.

SPECIFICATIONS

TYPE NO.		1419-A			1419-K			219-M		
<i>Type 980 Decades Used</i>		A	B	C	F	G	H	L	M	N
<i>Capacitance per Step (μf)</i>		0.1	0.01	0.001	0.1	0.01	0.001	0.1	0.01	0.001
<i>Dielectric</i>		Polystyrene			Mica			Paper	Mica	Mica
<i>Maximum Capacitance of Box (μf)</i>		1.110			1.110			1.110		
<i>Zero Capacitance (μf)</i>	<i>2-terminal</i>	37			41			35		
	<i>3-terminal</i>	15			13			Two-terminal only		
<i>Accuracy¹</i>	<i>2-terminal</i>	$\pm 1\%$	$\pm 1\%$	$\pm 1\%$	$\pm 0.5\%$	$\pm 0.5\%$	$\pm 0.5\%$	$\pm 2\%$	$\pm 1\%$	$\pm 1\%$
	<i>3-terminal</i>	$\pm 1\%$	$\pm 1\%$	$\pm 1.5\%$	$\pm 0.5\%$	$\pm 0.5\%$	$\pm 1\%$	Two-terminal only		
<i>Dissipation Factor at 1 kc</i>		<0.0002			<0.0003			<0.01	<0.001	<0.001
<i>Insulation Resistance in ohms at 100 v, 23° C, 50% RH</i>		>10 ¹²			>3.5 × 10 ⁹			>10 ⁸		
<i>Temperature Coefficient of Capacitance (ppm/° C)</i>		-140, nominal			+35 ± 10			—		
<i>Maximum Operating Temperature (°C)</i>		65			90			65		
<i>Maximum Operating Voltage (DC or peak)</i>		500			500			300	500	500
<i>Frequency Characteristic</i>		Similar to those for the TYPE 980 Decade Capacitance Units, modified by the additional inductance and resistance at the box terminals and wiring.								
<i>D-C cap</i>		<1.001			Typically 1.03					
<i>1-kc cap</i>										
<i>Dielectric Absorption</i>		See Voltage Recovery								
<i>Voltage Recovery²</i>		<0.1%			<3%					
<i>Terminals</i>		3 TYPE 938 Binding Posts with grounding link			3 TYPE 938 Binding Posts with grounding link			2 TYPE 938 Binding Posts		
<i>Mounting</i>		Aluminum Panel and Cabinet			Aluminum Panel and Cabinet			Aluminum Panel and Shielded Hardwood Cabinet		
<i>Over-all Dimensions (Inches)</i>		13 × 4-5/16 × 5			14-1/8 × 5-1/2 × 6			13-3/4 × 5-1/2 × 5-7/8		
<i>Net Weight (Pounds)</i>		8-3/8			11-1/4			5-5/8		
<i>Code Word</i>		BIGOT			CREEK			BRIER		
<i>Price</i>		\$205.00			\$270.00			\$135.00		

¹Capacitance increments from zero position are within this percentage of the indicated value for any setting.

²% of original charging voltage after a charging period of one hour and a 10-second discharge through a resistance equal to one ohm per volt of charging.





TYPE 980 DECADE CAPACITOR UNIT



TYPE 980-F



TYPE 980-C



TYPE 980-L



USES: The TYPE 980 Decade Capacitor Units are compact, convenient assemblies of high-grade capacitors mounted on an eleven-point switch to give a total capacitance variation of 10:1 in ten equal increments. They can be built into tuned circuits, wave filters, oscillators, analyzers, amplifiers, equalizers, and other permanent or experimental equipment.

Decades are available in three different dielectric materials: paper, for uses where dissipation factor is not critical; silvered mica for better dissipation factor and use in higher ambient temperatures; and polystyrene, for applications requiring very low dielectric absorption and constancy of both capacitance and dissipation factor as a function of frequency.

DESCRIPTION: Each decade consists of four capacitors of magnitudes in the ratio of 1, 2, 2, 5. The switch selects parallel combinations to give all integral values between 1 and 10.

The switch is rigidly constructed and includes a detent mechanism for positive location of position. The switch dielectric, includ-

ing the shaft, is heat-resistant, cross-linked polystyrene. Contacts are made by cams bearing on phosphor-bronze springs, the whole contact structure being heavily silver plated.

Units are furnished complete with knob, photo etched dial plate, and switch stops. The switch, with dial plate and knobs, is available separately (see price list).

FEATURES:

- All component capacitors are carefully selected and aged for maximum stability with time.
- Paper-dielectric units are thoroughly impregnated with microcrystalline wax, one of the most effective sealers against moisture. Winding is non-inductive with the foil projecting at each end of the roll, which minimizes dissipation factor and residual inductance.
- Mica-dielectric decades use silvered mica molded elements for TYPES 980-M and -N and TYPE 505 units for the TYPES 980-F, G, and H.
- Polystyrene decades have high insulation resistance, low dielectric absorption and low losses.

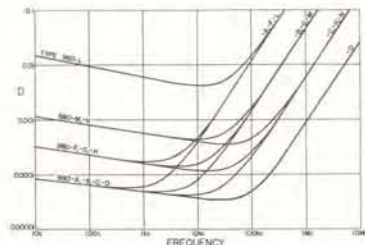
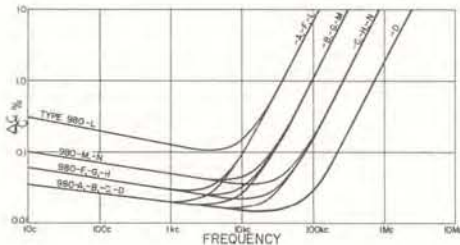

(Left) Typical plot of change in capacitance at maximum setting of each decade as a function of frequency. The capacitance curves are referred to the value the capacitor would have if there were no interfacial polarization and no series inductance. Since the capacitors are adjusted to their rated accuracy at 1 kc, the 1-ke value on the plots should be used as a basis of reference in estimating the frequency error. (Right) Typical plot of dissipation factor as a function of frequency.



Panel space and mounting dimensions of Type 980 Decade-Capacitor Units.

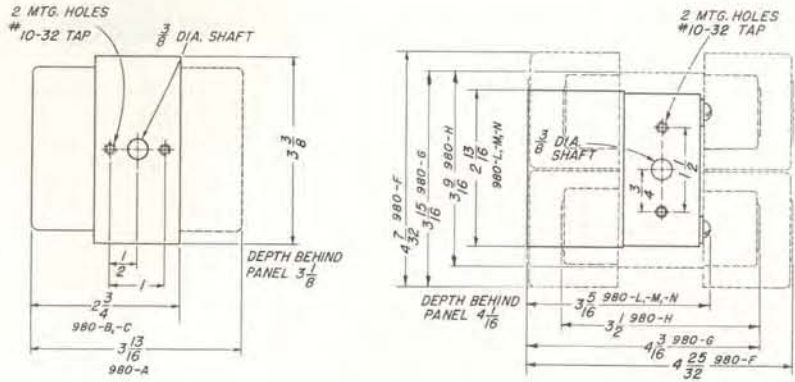

SPECIFICATIONS

TYPE	980-A	980-B	980-C	980-D	980-F	980-G	980-H	980-L	980-M	980-N
Maximum Capacitance (μf)	1.0	0.1	0.01	0.001	1.0	0.1	0.01	1.0	0.1	0.01
Capacitance per Step (μf)	0.1	0.01	0.001	0.0001	0.1	0.01	0.001	0.1	0.01	0.001
Zero Capacitance	2-terminal connection									
	Approximately 11 μf									
Dielectric	3-terminal connection									
	<1 μf									
Accuracy ¹	Polystyrene				Silvered Mica (General Radio Type 505)			Paper	Characteristic -C Silvered Mica (Molded)	
	2-terminal connection ²	$\pm 1\%$		$\pm (1\% + 2\mu\text{f})$	$\pm 0.5\%$			$\pm 2\%$	$\pm 1\%$	
Dissipation Factor	3-terminal connection	$\pm 1\%$	$\pm 1\%$	$\pm 1.5\%$	$\pm 1\%$	$\pm 0.5\%$	$\pm 0.5\%$	$\pm 1\%$	$\pm 2\%$	$\pm 1\%$
		<0.0002				<0.0003			<0.01	<0.001
Insulation Resistance at 100 v, 25°C, 50% RH (ohms)	-140 nominal				+35 \pm 10			EIA Characteristic C		
	500				500			300	500	
Temperature Coefficient of Capacitance ppm/°C	10 kc	100 kc	1 Mc	10 Mc	10 kc	100 kc	1 Mc	1 ke	100 kc	1 Mc
	See Figure 4									
Maximum Operating Voltage ³ (DC or peak)	65				90			65	90	
	See Voltage Recovery				See Voltage Recovery			See Voltage Recovery		
Frequency Limit for Maximum Voltage ³	<0.1%				<3%			—		
	Flexible leads									
Frequency Characteristic	Machine screws are furnished									
Maximum Operating Temperature (°C)	See sketch									
Dielectric Absorption	$2 \frac{1}{8}$				$3 \frac{3}{4}$	2	$1 \frac{5}{8}$	$1 \frac{5}{8}$	$1 \frac{1}{2}$	$1 \frac{1}{2}$
Voltage Recovery ⁴	AVAST	AVERT	AVOID	ALIEN	ACUTE	AVOWD	AWAIT	ADAGE	ADDER	ADDLE
Terminals	\$66.00	\$51.00	\$57.00	\$57.00	\$132.00	\$60.00	\$45.00	\$36.00	\$42.00	\$32.00
Mounting Hardware										
Dimensions										
Net Weight (Pounds)										
Code Word										
Price										

¹Capacitance increments from zero position are within this percentage of the indicated value for any setting.

²Units are checked with switch mechanism high, electrically, and the common lead and case grounded.

³At frequencies above the indicated maximum, the allowable voltage decreases and is (approximately) inversely proportional to frequency. These limits correspond to a temperature of 40°C for a power dissipation of 2.5 watts for Type 980-F, one watt for Types 980-G and -H, and 3.5 watts for all other units.

⁴% of original charging voltage after a charging period of one hour and a 10-second discharge through a resistance equal to one ohm per volt of charging.



TYPE 1429-A FUEL-GAGE TESTER



USES: The TYPE 1429-A Fuel-Gage Tester meets the need for an accurate device for calibrating modern capacitance-type fuel-gage systems. It meets the requirements for testing and calibrating the gages in both reciprocating-engine and jet-engine planes.

DESCRIPTION: This tester fulfills the same function as the military TYPE MD-1 Tester,

but has smaller dimensions and lower weight. It contains two 3-terminal, 200- μf - ΔC air capacitors, one to simulate the jet fuel compensator, the other in conjunction with fixed mica capacitors to simulate the main sensing capacitor of the fuel gage. Both air capacitors have brass rotor and stator plates soldered into their supports, then nickel-plated and mounted in a rigid, five-sided, cast-aluminum frame. The capacitor worm drive is individually ground in to fit the one-piece, spring-pressed worm and shaft to the precision worm wheel.

The main capacitor is extended in value to 6200 μf by two sets of switched, solder-sealed, precision, silvered-mica, fixed capacitors, one having five steps of 200 μf , the other five steps of 1000 μf .

External connections are made through keyed coaxial connectors. Cables and adaptors as required by specification MIL T-8579 (USAF) are stowed in a separate compartment at the right end of the transit case.

FEATURES:

- Protected from moisture and vibration.
- High precision of setting—one part in 25,000 of full scale; scale length is 19.2 feet.
- High accuracy.
- Low backlash.
- Low temperature coefficient of capacitance.
- Low dielectric losses.
- Direct reading in capacitance.
- Fulfills functions and environmental requirements of military MD-1 Tester.

SPECIFICATIONS

Capacitance Range: Main capacitor continuously variable linearly from 20 to 220 μf , thence by switched steps of 200 μf to 6220 μf . Compensating capacitor continuously variable linearly from 10 to 210 μf .

Accuracy: Capacitance of the main variable air capacitor is indicated by dial reading within $\pm 0.5\%$ or $\pm 0.75 \mu\text{f}$, whichever is greater. Corresponding figures for the compensating variable air capacitor are $\pm 1.5\%$ or $\pm 0.5 \mu\text{f}$, whichever is greater. Switched capacitors are accurate to $\pm 0.5\%$.

Correction Chart: A correction chart laminated between plastic sheets for mechanical and climatic protection is supplied, giving corrections at multiples of 10 μf for the variable capacitors and at each switch position for the stepped capacitors. When these corrections are applied, the capacitance is correct to plus or minus 0.1% or 0.15 μf , whichever is greater.

Maximum Voltage: 500 volts peak.

Dielectric Supports: Plates of low-loss steatite support the stator assembly, glass-bonded-mica washers, the rotor.

Dielectric Losses: Almost negligible for the air capacitors, since solid insulation is largely outside the electric field. Not over 0.001 for the switched silvered-mica capacitors.

Temperature Coefficient of Capacitance: For small temperature changes, approximately $+0.002\%$ per degree Centigrade for air capacitors, $+0.0035\%$ for mica ones.

Backlash: Less than one-third division (out of 2000), corresponding to 0.02% of full-scale value. If the desired setting is always approached in the direction of increasing scale reading, no error from this cause will result.

Terminals: Three special, keyed, coaxial connectors, the center one of which is connected to both rotors.

Mounting: All capacitors and a renewable desiccant cartridge are mounted on an aluminum panel and enclosed in a moisture-sealed aluminum cabinet. The latter is shock mounted in an aluminum transit case with carrying handle, which also contains a compartment to hold nine connecting cables and three tee adaptors.

Dimensions: (Height) $10\frac{1}{2}$ (width) $17\frac{1}{2}$ (depth) $10\frac{1}{2}$ inches, over-all.

Weight: $28\frac{3}{4}$ pounds.

Type	Code Word	Price
1429-A Fuel-Gage Tester.....	GAGER	On Request



STANDARD INDUCTORS



The desirable attributes of any inductor to be used as a laboratory standard include:

- (1) High stability of inductance value.
- (2) Small variation of inductance with frequency.
- (3) Small variation of inductance with current.
- (4) High Q at the desired operating frequency.
- (5) Low temperature coefficient.
- (6) Reasonable physical size.
- (7) High degree of astaticism.

On the following pages are described a number of both fixed and variable inductors representing different economic compromises among the above factors.

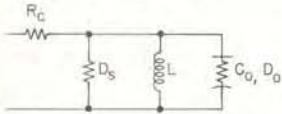

FIGURE 1. Equivalent circuit of an air-cored inductor L .

▶ AIR-CORED INDUCTORS

High stability, low temperature coefficient, and negligible variation of inductance with current are best met by toroidal air-cored inductors, as exemplified by the TYPE 1482 Standard Inductors, whose symmetrical and rigid coil construction has proved to be stable over several years to better than 0.02 percent. The variation of series inductance, L , with frequency is a dual phenomenon that gives a minimum L somewhere between 200 c and 2 kc. At frequencies so low that Q is less than unity the effect of eddy currents predominates, and causes a decrease in L with increasing f . At higher frequencies, where Q exceeds unity, the effect of the distributed capacitance, C_0 , of the coil predominates which causes L to increase with f . For frequencies well below the resonant f_0 value the fractional increase in L due to C_0 is approximately

$$\frac{\Delta L}{L} = \left(\frac{f}{f_0}\right)^2 = \omega^2 L C_0.$$

No variation of inductance with current occurs, and an air-cored inductor can be considered as an ideally linear circuit element.

The losses in an air-cored inductor are (a) an "ohmic" or $I^2 R_c$ loss from the series resistance of the winding, (b) a loss in the copper caused by eddy currents, and (c) dielectric losses in the insulation. An equivalent circuit taking these losses into account is shown in Figure 1.

The effects of the various loss components are most easily represented by the plot of dissipation factor against frequency, Figure 2. In logarithmic coordinates, the three dissipation-factor components of an air-core inductor can all be represented by straight lines as shown. The component, D_e , caused by the d-c resistance of the winding, varies inversely with frequency, while D_s due to eddy-current loss in the copper (and associated with skin-effect), is directly proportional to the frequency. The dissipation factor, D_0 , of the distributed capacitance of the winding produces D_d , which is proportional to the square of the frequency within the significant range where D_0 is independent of frequency. Note that D_d reaches the value D_0 at f_0 . The total dissipation factor, D , is the sum of these three components and has a minimum value which occurs well below the natural frequency, f_0 , of the inductor.

It will be observed that at low frequencies the dissipation factor, D , is determined entirely by series resistance, while at high frequencies the eddy current and dielectric losses predominate.

The minimum value of dissipation factor obtainable depends upon the geometry of the coil and upon the diameter of the wire. Insulated stranded wire (Litzendraht) is frequently employed to reduce D , by using small individual wire diameters.

▶ IRON-CORED INDUCTORS

A larger inductance can be obtained in a given volume, or with a given amount of copper, if a core material of high permeability is used. The term "iron" is used loosely and generically to identify such ferromagnetic materials, although these materials are highly developed special alloys, in sheet, strip, or bonded granular form.

The economy in coil construction resulting from the use of "iron" cores is obtained with some sacrifice of performance in an inductor used as a calibrated standard. Stability is ordinarily reduced, since the inductance depends not only on geometry but also on the permeability of the core material. This permeability will vary somewhat with current, because of its inherent change with magnetizing force, and may also be subject to a slight aging. By proper design and choice of core material, as exemplified by the TYPES 940, 1490, and 1481, inductors satisfactory as secondary standards and as adjustable decade elements can be realized.

In an iron-cored inductor, lower values of D_e and D_s can be obtained, due to the increase of effective permeability, while D_0 remains unchanged and f_0 is reduced somewhat. Three other linear core components of dissipation factor must be added to the winding components shown in Figure 2. Eddy currents in the core produce a component, D_e , which, like D_s , is directly proportional to the frequency and which is minimized in a dust core made by molding fine iron powder in an insulating binder. However, by the use of fine wire, D_e can be made negligible compared to D_s . The hysteresis component of dissipation factor, D_h , is independent of frequency but, since it is proportional to the magnetizing force, it becomes vanishingly small as the operating level approaches zero (initial permeability). The relatively small component, D_r , caused by residual losses in the iron is constant with frequency and, like D_h , would be represented by a horizontal line in Figure 2.

FIGURE 2. Dissipation factor variation with frequency showing the relative contributions of the several loss components.

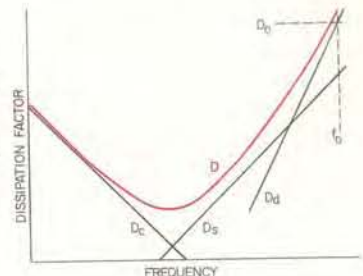



TYPE 1482 STANDARD INDUCTOR



USES: The TYPE 1482 Standard Inductor is an accurate and highly stable standard of self-inductance for use as a primary standard in the laboratory and as a precise working standard at low audio frequencies.

DESCRIPTION: Each inductor is a uniformly wound toroid on a ceramic core. It has a negligible external magnetic field and essentially no pick-up from external fields. The inductor is resiliently supported in a mixture

of ground cork and silica gel, after which the whole assembly is cast with a potting compound into a cubical aluminum case.

Three terminals are provided, two for the inductor leads and the third connected to the case to afford either a two- or three-terminal standard. Prior to calibration these inductors are thermally aged to equalize winding strains. Calibrations are made with the low terminal of the winding grounded to case by a metal link between the two binding posts. Calibrations are made at 100 c in terms of a similar inductor, certified by the National Bureau of Standards. An individual calibration certificate gives corrections applicable at 200 c, 500 c and 1 kc.

FEATURES:

- High stability of inductance.
- Free from mounting strains and humidity errors.
- Inductance independent of voltage.
- Precisely adjusted and accurately calibrated at specified room temperature.
- Highly astatic, and electrostatically shielded.
- Low and known temperature coefficient.

SPECIFICATIONS

Inductance Range: See price table.

Temperature Coefficient of Inductance: Approximately +30 ppm per degree C. Minute temperature corrections may be computed from d-c resistance.

Accuracy: Nominal limits of adjustment, see table. Limits of measured certificate value, referred to National Bureau of Standards certification, see table.

D-C Resistance: See table for representative values.

Low-Frequency Dissipation Factor: At low frequencies, the dissipation factor (essentially from d-c resistance) is given approximately by $D = K/f$. See table for K.

Resonant Frequency: See table.

Maximum Input Power: For 20° C. rise, 3 watts.

For precise work, 1.5° C. rise, 200 milliwatts. See table for corresponding current limitations.

Mounting: Aluminum cabinet with carrying handle and rubber feet.

Terminals: Two insulated jack-top terminals, plus jack-top ground terminal and strap.

Dimensions: 6½" x 6½" x 8" height over-all.

Weight: 11½ pounds.

Type	Nominal Inductance	Nominal Limits at 100 cps %	Limits of 100 cps Certificate Value %	*Resonant Frequency Kc	*D-C Resistance Ohms	*K Values	Milliamperes		Code Word	Price
							rms for 200 mw	3w		
1482-B	100 μh	±0.25	±0.10	3020	0.17	277	1090	4200	INDUCTOTAG	\$105.00
1482-C	200 μh	±0.25	±0.05	1880	0.23	186	930	3600	INDUCTOTED	105.00
1482-D	500 μh	±0.1	±0.05	1090	0.42	132	690	2670	INDUCTOTIM	105.00
1482-E	1 mh	±0.1	±0.03	815	0.89	142	475	1830	INDUCTOTOP	105.00
1482-F	2 mh	±0.1	±0.03	590	1.56	124	360	1390	INDUCTOTUB	105.00
1482-G	5 mh	±0.1	±0.03	350	3.82	122	230	890	INDUCTOVAT	105.00
1482-H	10 mh	±0.1	±0.03	230	8.4	134	154	600	INDUCTOVEX	105.00
1482-J	20 mh	±0.1	±0.03	150	14.9	119	116	450	INDUCTOWAD	105.00
1482-K	50 mh	±0.1	±0.03	90	38.5	122	72	280	INDUCTOWET	105.00
1482-L	100 mh	±0.1	±0.03	60	67	107	55	210	INDUCTOWIG	105.00
1482-M	200 mh	±0.1	±0.03	41	110	87	42	165	INDUCTOWOW	105.00
1482-N	500 mh	±0.1	±0.03	25	270	86	27	105	INDUCTOYAK	105.00
1482-P	1 h	±0.1	±0.03	16.6	475	75	21	80	INDUCTOYES	110.00
1482-Q	2 h	±0.1	±0.03	11.0	1090	87	13.5	52	INDUCTOBUG	130.00
1482-R	5 h	±0.1	±0.03	7.9	3550	113	7.5	29	INDUCTOBIN	160.00
1482-T	10 h	±0.1	±0.03	5.8	7980	127	5.0	19	INDUCTOBAL	210.00

*Representative values. Actual values given on certificate.





USES: The TYPE 1481 Inductors have higher low-frequency values of storage factor *Q* than the TYPE 1482 Standard Inductors. They are useful at audio frequencies as standards of self-inductance, although their accuracy of adjustment is not so high as that of the TYPE 1482 Inductors, and, for some uses, allowance must be made for their current coefficient of inductance.

DESCRIPTION: These inductors are uniformly wound toroidal units on stabilized molybdenum-permalloy dust cores, identical in construction with the toroids used in TYPE 940 Decade Inductor Units.

TYPE 1481 STANDARD INDUCTOR



FEATURES:

- Inherently astatic.
- Electrostatically shielded.
- High storage factor, *Q*—between 230 and 300, maximum.
- *Q* is greater than 1 down to 6 cycles.

SPECIFICATIONS

Accuracy: See table below. Accuracy of adjustment is limited to the change produced by a single turn of the winding. Nominal value of inductance, with tolerance limits, and current for 0.25% change in inductance, are engraved on the case. Calibration is at initial permeability. **Storage Factor, *Q*:** Maximum initial *Q* is between 230 and 300. The plot of Figure 1 shows the variation of dissipation factor ($D = \frac{1}{Q}$) as a function of frequency for initial permeability, i.e., with no hysteresis loss. Hysteresis loss for an r-m-s current *I* in terms of *I*₁ (see table) will add approximately .001 $\frac{I}{I_1}$ directly to *D*.

Current Coefficient of Inductance: Per cent change in inductance as a function of $\frac{I}{I_1}$ is given in Figure 1, page 180, where *I* is the r-m-s operating current and *I*₁ the current that would produce a 0.25% linear increase in *L*.

Incremental Inductance: D-C bias will reduce the initial inductance as shown in Figure 1, page 180.

Frequency Characteristics: Per cent change in inductance with frequency is plotted in Figure 2, below.

Temperature Coefficient of Inductance: Approximately -25 ppm per degree C. between 16° and 32°C.

Safe Operating Limits: (1) Maximum terminal voltage, 500 volts, r-m-s or (2) maximum r-m-s current = 70 *I*₁, whichever limit is pertinent.

Distributed Capacitance: Between 28 μf for the 1-mh unit and 33 μf for the 5-h unit.

Mounting: Aluminum case.

Terminals: Jack-top binding posts, one grounded to case. A pair of double-ended plugs is furnished, for connection to jack-top binding posts.

Dimensions: Case (height) 3 $\frac{1}{8}$ x (width) 3 $\frac{1}{8}$ x (depth) 1 $\frac{5}{8}$ inches; over-all height, including terminals, 4 $\frac{5}{8}$ inches.

Net Weight: 14 ounces.

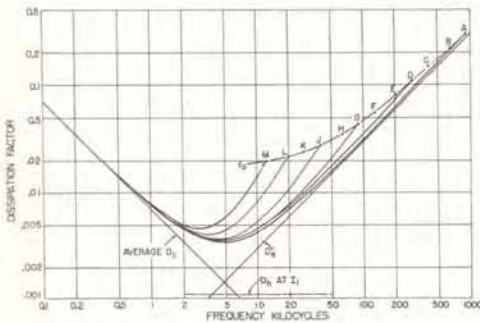

(Left) FIGURE 1. Initial *D* versus frequency for typical units (*D*_h = 0).

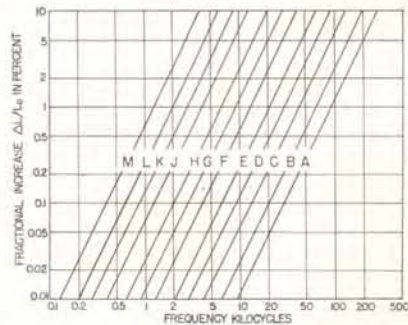

(Right) FIGURE 2. Percent increase in *L*₀ with frequency.

Type Inductor	Nominal Inductance <i>L</i>	Accuracy %	R-M-S Current, <i>I</i> ₁ , for 0.25% increase in <i>L</i> ₀ ma	Resonant Frequency <i>f</i> ₀ kc	Approx. D-C Resistance Ω	Code Word	Price
1481-A	1 mh	±1	24	940	0.043	INDUCTOSAP	\$32.50
1481-B	2 mh	±1	17	660	0.098	INDUCTOSET	32.50
1481-C	5 mh	±1	11	420	0.25	INDUCTOSIG	32.50
1481-D	10 mh	±0.5	7.6	300	0.44	INDUCTOSOT	32.50
1481-E	20 mh	±0.5	5.4	210	0.95	INDUCTOSUM	32.50
1481-F	50 mh	±0.5	3.4	130	2.31	INDUCTOPAL	32.50
1481-G	100 mh	±0.25	2.4	91	4.3	INDUCTOPEG	35.00
1481-H	200 mh	±0.25	1.7	64	7.2	INDUCTOPIT	35.00
1481-J	500 mh	±0.25	1.1	40	22	INDUCTOPOD	35.00
1481-K	1 h	±0.25	0.76	28	40	INDUCTOPUB	35.00
1481-L	2 h	±0.25	0.54	20	91	INDUCTORAM	37.50
1481-M	5 h	±0.25	0.34	12.5	230	INDUCTORED	40.00





TYPE 107 VARIABLE INDUCTOR



USES: The TYPE 107 Variable Inductors find their greatest uses in the laboratory as adjustable standards of moderate accuracy for measurements of self and mutual inductance, and as circuit elements in bridges, oscillators, and similar equipment.

DESCRIPTION: Two coils, a rotor and a stator,

are mounted concentrically. As the position of the rotor is changed, the coupling between the two coils and the inductance, hence, changes.

In most models stranded wire is used, in which the separate strands are insulated from one another. The coils are impregnated and baked in a high-melting-point material before being securely mounted to the phenolic panel.

Direct reading in inductance for the series connection of the coils. Inductance for the parallel connection is exactly one-fourth the value shown by the dial.

FEATURES:

- Continuous adjustment of self or mutual inductance.
- Rotor and stator may be quickly connected in either series or parallel as a self-inductor, or used separately as a mutual inductor.
- Rotor and stator inductances have been equalized so that losses are not appreciably increased by circulating currents when the parallel connection is used.

SPECIFICATIONS

Self-Inductance Range: See table below.

Mutual Inductance: See table below. Either positive or negative values of mutual inductance can be obtained. The exact formula for the mutual inductance is engraved on each individual instrument.

Calibration: The inductance for the series connection, measured at 1 kc and accurate within $\pm 1\%$ of full-scale reading, is engraved on the dial. The inductance for the parallel connection is one-fourth of the series inductance within $\pm 0.1\%$.

The mutual inductance accuracy is $\pm 2.5\%$ of the maximum mutual inductance value.

Frequency Error: The fractional increase in inductance with frequency will be f^2/f_0^2 where f is the operating frequency and f_0 the natural frequency, which can be

calculated from $f_0 = \frac{1}{2\pi\sqrt{LC_0}}$ Values of C_0 are tabu-

lated below. See plot for change in dissipation factor with frequency.

Maximum Power and Current: Current for 15 watts maximum dissipation, corresponding to a 40° C temperature rise, is given in the table below and is engraved on the nameplate.

D-C Resistance: See table below. These series connection values are engraved on the nameplate. For parallel

connections the resistance is closely $\frac{1}{4}$ the tabulated values.

Terminals: Standard $\frac{3}{4}$ -inch spacing, jack-top binding posts are provided which allow separate connections to rotor and stator. Connecting links are supplied so that either a series or parallel connection of the rotor and stator can be made available at a third pair of binding posts.

Mounting: All units are mounted on phenolic panels and enclosed in non-shielded hardwood cabinets.

Dimensions: $6\frac{1}{2} \times 6\frac{1}{2} \times 8\frac{3}{4}$ inches high, over-all

Net Weight: 5 pounds, all ranges.

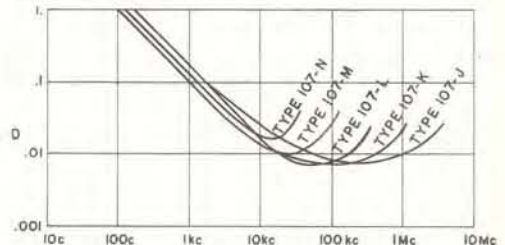

Dissipation factor ($D = 1/Q$) versus frequency at full-scale, series connection.

Type	Self-Inductance		Mutual Inductance	Typical C_0 Values		D-C Resistance Ω	Maximum Current a	Code Word	Price
	Series	Parallel		Series	Parallel				
107-J	9- 50 μh	2.25-12.5 μh	0-10.8 μh	35 μf	57 μf	0.05	16.	HAREM	\$85.00
107-K	90-500 μh	22.5-125 μh	0-110 μh	40 μf	72 μf	0.38	6.	HARPY	85.00
107-L	0.9- 5 mh	0.225-1.25 mh	0-1.1 mh	39 μf	73 μf	4.6	1.7	HARRY	90.00
107-M	9- 50 mh	2.25-12.5 mh	0-11 mh	34 μf	41 μf	32	0.65	HOTEL	95.00
107-N	90-500 mh	22.5-125 mh	0-110 mh	34 μf	41 μf	440	0.18	HOVER	95.00





USES: These boxes are particularly useful in circuit development and experimental filters, equalizers, and other networks.

DESCRIPTION: The TYPE 1490 Decade Inductor is an assembly of three or four TYPE 940 Decade-Inductor Units (described below) in a single metal cabinet. The units have no electrical connection to the panel, but a separate ground terminal is provided which can be connected to the adjacent "low" terminal, which leads to the smallest decade.



**TYPE 1490
DECADE
INDUCTOR**

SPECIFICATIONS

Frequency Characteristics: By vertical interpolation in the accompanying plot the percentage increase in effective series inductance (above the geometric value when $f = 0$) may be obtained for any setting of the highest-valued decade used, when the LOW terminal is grounded to the cabinet.

Zero Inductance: Approximately 1 μ h.

Terminals: Jack-top binding posts.

Mounting: The decades are mounted on an aluminum panel in a metal cabinet.

Dimensions: 1490-C 12 $\frac{3}{4}$ \times 8 $\frac{1}{2}$ \times 5 $\frac{1}{2}$ inches over-all height. 1490-D 16 $\frac{3}{4}$ \times 8 $\frac{1}{2}$ \times 5 $\frac{1}{2}$ inches over-all height.

Net Weight: TYPE 1490-C, 16 $\frac{3}{4}$ pounds; TYPE 1490-D, 21 $\frac{3}{4}$ pounds.

Other specifications are identical with those for the TYPE 940 Decade-Inductor Units.

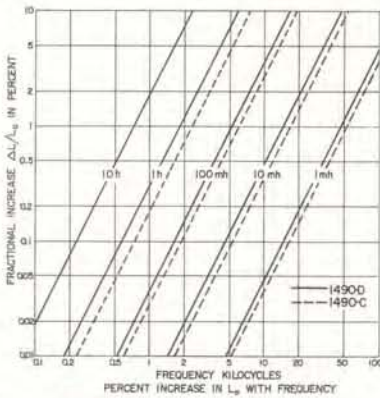

Type		Code Word	Price
1490-C	1.11 h, total, in steps of 0.001 h	CLUMP	\$330.00
1490-D	11.11 h, total, in steps of 0.001 h	COACH	440.00

Note: The TYPE 1432 Decade Resistor and the TYPE 1419 Decade Capacitor can be found on pages 150 and 170 respectively.

TYPE 940 DECADE-INDUCTOR UNIT



USES: The TYPE 940 Decade-Inductor Units are convenient elements for use in wave filters, equalizers, and tuned circuits throughout the range of audio and low-radio frequencies. As components in oscillators, analyzers, and similar equipment, they are especially useful during the preliminary design period when the ability to vary circuit elements over relatively wide ranges is necessary to determine optimum operating values. As moderately precise standards of inductance they have values of low-frequency storage factor, Q , which are much larger than those of air-cored coils.

DESCRIPTION: Each unit is an assembly of four toroids (relative values 1, 2, 2.5) wound on molybdenum-permalloy dust cores, which are combined by switching to give the eleven successive values from 0 to 10. The decade switch has high-quality, ceramic stator-and-rotor members and utilizes a well-defined ball-and-socket detent. All contacts are made of a solid-silver alloy and have a positive wiping action.

FEATURES:

- High values of storage factor Q are obtained in all models, with maximum values above 200.
- Toroidal construction minimizes external magnetic fields, so that the coils can be stacked without errors from mutual inductance. The toroids are nearly astatic to external magnetic fields.
- Aluminum covers provide electrostatic shielding and mechanical protection.
- Wax impregnation keeps out moisture.
- The switch is inherently reliable in extensive use and should not require bothersome cleaning or adjustment in service.





SPECIFICATIONS

Accuracy: Each unit is adjusted so that its inductance at zero frequency and initial permeability will be the nominal value within the accuracy tolerance given in the following table:

Inductance per step	1 mh	10 mh	100 mh	1 h
Accuracy	±2%	±1%	±0.5%	±0.25%

Frequency Characteristics: For any specific operating frequency, Figure 2 shows the percentage increase in effective series inductance (above the geometric value when $f = 0$) which is encountered with the extreme settings of each of the four Decade Inductor Units when the chassis is floating. Vertical interpolation may be used for intermediate settings.

FIGURE 1. Percent change in normal and incremental inductance with a-c and bias current. Incremental curve is limited to an a-c excitation less than I_1 .

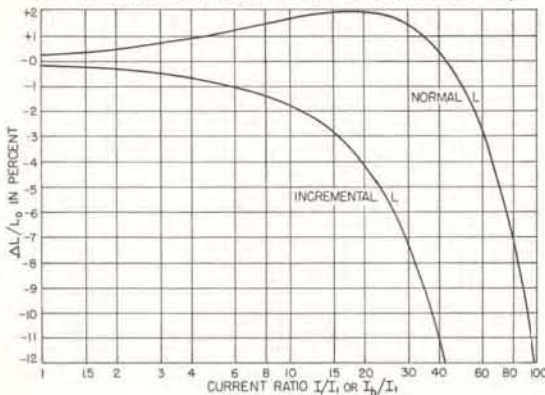

Change in Inductance with Current: Fractional change in initial inductance with a-c current for each size of toroid is shown in the normal curve, Figure 1, in terms of the ratio of the operating current I , to I_1 , the current for 0.25% change. For ratios below unity, inductance change is directly proportional to current. Values of I_1 listed below are approximate and are based on the largest inductor in circuit for each setting.

Switch Setting	RMS I_1 (ma) for 0.25% Increase			
	940-E	940-F	940-G	940-H
1	24	7.6	2.4	0.76
2, 3, 4	17	5.4	1.7	0.54
5, 6, 7, 8, 9, 10	11	3.4	1.1	0.34

Incremental Inductance: D-C bias current I_b will reduce the initial inductance as shown in the incremental curve, Figure 1.

Type	Inductance	Code Word	Price
940-E	0.01 h in 0.001 h steps.....	INDUCTOANT	\$100.00
940-F	0.1 h in 0.01 h steps.....	INDUCTOBOY	100.00
940-G	1 h in 0.1 h steps.....	INDUCTOCAT	100.00
940-H	10 h in 1 h steps.....	INDUCTODOG	110.00

Note: decade-resistor units and decade-capacitor units are listed on pages 157 and 172 respectively.

FIGURE 2. Percent increase in L_0 with frequency.

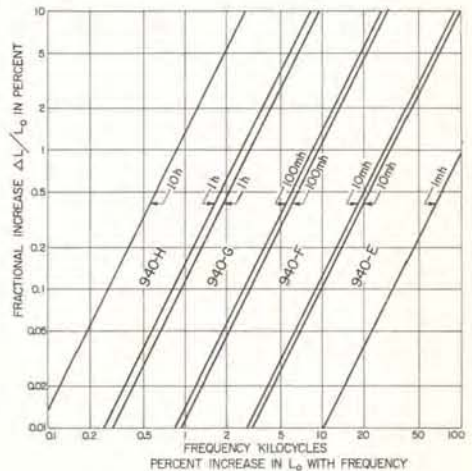

Dissipation Factor: See Figure 3.

D-C Resistance: Approximately 45 ohms per henry.

Temperature Coefficient: Approximately -25 ppm per degree C between 16 and 32° C.

Maximum Voltage: 500 volts rms. The switch will break the circuit at 500 volts if turned rapidly to the new setting, but voltages above 150 may cause destructive arcing if the switch is set between detent positions.

Maximum Current: 70 times the pertinent I_1 value.

Terminals: Soldering lugs are provided. Circuit insulated from chassis.

Mounting: Each decade is complete with dial plate, knob, and mounting screws.

Dimensions: (Width) 8 × (height) 3½ × (depth behind panel) 3¼ inches, over-all.

Net Weight: 3½ pounds.

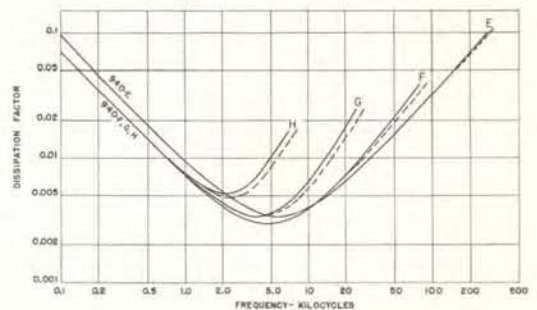

FIGURE 3. Variation of dissipation factor for the full value of each inductor. Dashed curves correspond to use with chassis floating.





INSTRUMENTS FOR THE MEASUREMENT OF SOUND AND VIBRATION

Measurement is an essential element in the efficient evaluation and control of noise and vibration. The necessary measurements are made possible by General Radio's comprehensive line of instruments.

These instruments are a result of a continuing development program since 1933, when General Radio announced its first noise meter. The standard sound-level meter, which succeeded the noise meter, is the basic sound-measuring instrument and has been improved in each successive model in performance, in convenience, and in versatility, culminating in the TYPE 1551-B Sound-Level Meter.

This instrument conforms to the American Standard on Sound-Level Meters.* An excellent, general-purpose microphone is supplied as standard equipment; but other transducer systems are available for specialized measurements. Their characteristics are tabulated on the next page.

The TYPE 1555-A Sound-Survey Meter is a simplified version of the sound-level meter, particularly designed for convenience in use, small-size, and low cost, and it is widely used when a single measuring instrument is satisfactory.

Either one of these instruments can be used to measure over-all level, and this value is the first important measure of a noise. A frequency analysis is also desirable in order to track down the source of the noise and to determine efficient control measures. For that reason the TYPE 1551-B Sound-Level Meter is designed to provide an output that is the amplified electrical replica of the acoustic signal at the microphone. This output signal can then be analyzed to determine its frequency spectrum by one or more of the General Radio analyzers listed on the next page. These include narrow band and broad-band types. The new TYPE 1554-A Sound and Vibration Analyzer has both narrow-band and third-octave responses. The characteristics of these and other analyzers are tabulated on page 222.

Satisfactory noise measurements depend on the use of measuring equipment that is kept in proper operating condition. Although the instruments are inherently reliable and stable, after long periods of use their performance may change. In order to insure that important changes will be discovered and corrected, the

TYPE 1552-B Sound-Level Calibrator has been developed. It provides a calibration of the over-all system at 400 cps. When driven by a 400-cycle oscillator at a 2-volt level and mounted on any of the microphones listed below, it supplies a known acoustic signal to the microphone. The TYPE 1307-A Transistor Oscillator is a convenient 400-cycle source.

The measurement of impact noise, which has previously required extensive instrumentation including a cathode-ray oscillograph, is now possible with a simple setup, consisting of the TYPE 1551-B Sound-Level Meter and the TYPE 1556-A Impact Noise Analyzer.

With these instruments, one can make the measurements that are necessary for evaluating practically any industrial noise problem. They can be used by non-technical personnel and are designed for long life and trouble-free operation. The use of these and other noise-measuring instruments is discussed thoroughly in the *Handbook of Noise Measurement*, published by the General Radio Company, and available at one dollar a copy, postpaid. A *Primer of Noise Measurement*, an elementary treatise, is free on request.

Vibration measuring equipment includes the TYPE 761-A Vibration Meter to measure acceleration, velocity, and displacement of a vibrating element; the TYPE 762-B Vibration Analyzer (or the TYPE 1554-A Sound and Vibration Analyzer) to analyze the vibration into its components; and the TYPE 759-P35 Vibration Pickup to convert the sound-level meter to a vibration meter.

The Graphic Recorder, TYPE 1521-A, can be used to record the level and spectral distribution of sound and vibration, operating from the output of the Sound-Level Meter, the Vibration Meter, or one of the analyzers.

Another important group of vibration instruments are stroboscopes, (see page 196) which permit vibrating objects to be viewed intermittently and produce the optical effect of slowing down or stopping a periodic vibration.

A section of the *Handbook of Noise Measurement* discusses the use of these instruments in typical vibration measurements.

*American Standard for Sound-Level Meters for the Measurement of Noise and Other Sounds (Z24.3-1944); American Standards Association, 70 East 45th St., New York 17, N. Y.





INSTRUMENTS

Type	Instrument	Application	Page
1551-B	Sound-Level Meter	Accurate measurement of noise level; measurement where analysis is required; measurements for conformity to noise test codes.	184
1555-A	Sound-Survey Meter	Preliminary noise surveys; routine checks; quick tests where an inconspicuous meter or extreme portability is desired.	183
1550-A	Octave-Band Analyzer	Analysis of wide-band noises; evaluation of speech-interference level and loudness.	190
760-B	Sound Analyzer	Analysis of pitched sounds, where a knowledge of individual frequency components is desirable.	193
1554-A	Sound and Vibration Analyzer	Analysis of both pitched and broad-band noises.	192
736-A	Wave Analyzer	Accurate measurement of individual frequency components of definite and stable pitch.	223
1556-A	Impact Noise Analyzer	Analysis of impact-type sounds and vibrations. Measurement of peak amplitude and duration of impulse-type signals.	191
1552-B	Sound-Level Calibrator	Over-all acoustic check of calibration of sound-level meters, sound-survey meters, and analyzers and for establishing reference levels.	189
761-A	Vibration Meter	Vibration measurements down to 2 cps.	194
762-B	Vibration Analyzer	Analysis of frequency components of vibration down to 2.5 cps.	193
1307-A	Transistor Oscillator	Test-tone source for TYPE 1552-B Sound-Level Calibrator.	107
1521-A	Recorder	Recording of sound-level spectrum components, transducer characteristics, etc.	147

TRANSDUCERS USED WITH SOUND-LEVEL METER

Type	Name	Uses	Sensitivity db re 1 volt/ μbar	Useful Level Range db re 0.0002 μbar	Freq- Range Cycles/ Sec.	Maxi- mum Temper- ature, °C	Maxi- mum Humid- ity*, %	See Page No.
1560-P1	Rochelle-Salt Crystal Microphone	Supplied with TYPE 1551-B Sound-Level Meter, General purpose (not recommended for use with long cable)	-56 to -60	24 to 150	20-8000	45	80	
759-P25	Dynamic Microphone Assembly	Replaces 1560-P1 when long cable is needed, and when temperature or humidity prevent use of crystal microphone	-56 to -60	24 to 140	35-10,000	75	100	187
1551-P1L	Condenser Microphone System	Replaces 1560-P1 for wide-frequency-range measurements; can be used with long cable	-56 to -60	50 to 150	20-18,000	100	80	186
1551-P1H	High-Level Condenser Microphone System	Replaces 1560-P1 for high-level and wide-frequency-range measurements; can be used with long cable	-70 to -76	70 to 170	20-18,000	100	80	186
759-P35 and 759-P36	Vibration Pickup and Control Box (Rochelle Salt Crystal Acceler- ometer)	Replaces 1560-P1 for vibration measurements	800 mv/g to 1000 mv/g	0.3 to 3900 in./sec. ² 0.001 to 31 in./sec. 30μin. to 0.25 in.	20-1200	45	80	188

*Rochelle Salt Crystal Units may be permanently damaged if exposed to high humidity for long periods.

The condenser microphones will not be permanently damaged, but will become noisy and inoperative as moisture reduces the insulation resistance between the active plates of the condenser. Storing microphone in dessicator is recommended.



TYPE 1555-A SOUND-SURVEY METER

The TYPE 1555-A Sound-Survey Meter is an inexpensive, pocket-sized instrument for use in general survey measurements.

This handy, versatile meter can be used for:

- Measuring noise levels in homes, offices, factories, and outdoor locations.
- Measuring noise levels produced by appliances, office equipment, and machinery.
- Preliminary surveys of noisy areas for estimating the possibility of hearing damage.
- Measuring level and dispersion pattern of reproduced sound from public-address systems, theater, and home sound systems.
- Surveys by field engineers for acoustic material companies.
- Acoustic experiments in physics classes.
- Establishing satisfactory levels for speakers and singers, at rehearsal and in classes.
- Determining cross-over characteristics and dynamic range of high-fidelity music reproducing systems.
- Measuring the frequency-response characteristic of loud speakers and rooms.

DESCRIPTION: The TYPE 1555-A Sound-Survey Meter consists of a non-directional microphone, a continuously-adjustable, calibrated attenuator, a stable amplifier with three weighting networks, and an easily read indicating meter.

SPECIFICATIONS

Range: From 40 db to 136 db (re 0.0002 microbar). Sound-level is sum of attenuator and meter readings.

Frequency Characteristic: Three different frequency characteristics can be selected by the main control switch. In the *C* and *C+30* db weighting positions substantially equal response to all frequencies between 40 and 8000 cps is obtained.

The *B* weighting position follows the 70-db contour established as the standard of weighting for sound-level meters. The *A* weighting position follows approximately the 40-db contour established for sound-level-meter weighting. These weighted responses also permit one to estimate, by comparative measurements with different weighting characteristics, the relative importance of low-frequency components in the sound being measured.

Accuracy: The *B* and *C* weighting positions are in accordance with the standard for sound-level meters established by the American Standards Association when the tolerance of the standard is increased by 1 db. The gain of the amplifier is so set that the sensitivity of the instrument is correct at 1000 cps within ± 1 db.

Stability: The amplifier is stabilized by feedback to mini-



The entire assembly, including microphone and batteries, is housed in a rugged, two-piece, aluminum case. The attenuator and weighting-network selector are fingertip operated. This permits one-hand operation of the instrument.

FEATURES:

- Small enough to fit in pocket.
- Can be used when set on a table, when mounted on tripod, or when held in hand.
- Miniature in size, yet it uses standard and well-tested components.

mize the effect of changes in battery voltage. Temperature and humidity changes over the normal range of room conditions have no noticeable effect. The temperature coefficient of the sound-level indication is low and is in the order of 0.03 db per degree F.

Operating Limits: The maximum safe operating temperature of the instrument is 115° F. Temperatures above 130° F will permanently damage the Rochelle-salt crystal in the microphone.

Microphone: A crystal diaphragm-type microphone is mounted at the top of the instrument.

Batteries: One 1½-volt size C flashlight battery (Rayovac LLP or equivalent) and one 30-volt hearing-aid battery (Eveready 413E or equivalent) are supplied.

Tube Complement: Two Raytheon CK-512-AX and two Raytheon CK-533-AX tubes.

Cabinet: Aluminum, finished in crackle and has a standard ¼-20 threaded tripod mount. A leather "ever-ready" carrying case is available, which permits operation of the instrument without removal from the case.

Dimensions: 6 × 3½ × 2½ inches, over-all.

Net Weight: 1 pound, 14 ounces, with batteries.

A Primer of Noise Measurement discusses sound and noise measurements with this instrument. Free copy on request.

Type		Code Word	Price
1555-A	Sound-Survey Meter	MISER	\$150.00
	Set of Replacement Batteries	MISERADBAT	1.95
1555-P2	Leather Carrying Case	CAGED	10.00

PATENT NOTICE: See Note 1, page x.

TYPE 1551-B SOUND-LEVEL METER

USES: This accurate, portable instrument measures the sound-pressure level at its microphone. In its *primary* function as a noise meter, this sound-level meter is the accepted instrument for the measurement of both product noise and environmental noise by industry, commercial laboratories, regulatory bodies, and noise-abatement groups.

Typical users include:

Machine and appliance manufacturers, in the development laboratory as well as on the production line. It provides a means of establishing noise standards and of accepting or rejecting products on the basis of noise tests.

Acoustical engineers and physicists, for the measurement of noise produced by machinery and for determining the acoustic properties of buildings, vehicles, and materials.

Industrial hygienists and psychologists, in surveys of the psychological and physiological effects of noise and for the determination of satisfactory noise environments in factories and offices.

Secondly, this sound-level meter constitutes with its accessories, a complete sound measuring system. The available accessories include spectrum analyzers, special-purpose microphones, and vibration pickups, as listed on the preceding page. Other accessories, such as graphic level recorders (see page 147) and tape recorders, can also be operated from the sound-level meter output.

In addition to its application in sound and noise measurement, this instrument can also be used as a portable amplifier, attenuator, and voltmeter for laboratory measurements in the audio-frequency range.

DESCRIPTION: The TYPE 1551-B Sound-Level Meter* consists of a non-directional microphone, a calibrated attenuator, an amplifier, standard weighting networks, and an indicating meter.

The complete instrument, including batteries, is mounted in an aluminum case. The microphone is mounted on a bracket, which per-



mits its use in either a vertical or a horizontal position. When not in use, the microphone folds down into a storage position, automatically disconnecting batteries. An ac power supply unit is available.

FEATURES:

- Small, compact, and easily portable—weighs less than 8 pounds with batteries.
- Simple to operate.
- Meets all standards of the American Standards Association, the American Institute of Electrical Engineers, and the Acoustical Society of America.
- Wide dynamic range.
- Output at terminals is well isolated from panel meter.
- Two-speed meter movement permits measurement of either steady or fluctuating sounds.
- Wide sound-level range—from 24 to 150 db.
- Sub-miniature tubes in negative-feedback amplifier circuits provide excellent stability.
- Batteries are readily available.
- Amplifiers and panel meter have wide frequency response, 20 cycles to 20 kilocycles.
- Low internal noise level.
- Internal calibration system for standardizing amplifier gain.
- Quasi-rms meter; indication is essentially rms for all waveforms except short impact pulses.

*For more detailed description consult *General Radio Experimenter* for October, 1958.



SPECIFICATIONS

Sound-Level Range: From 24 db to 150 db (re 0.0002 microbar).

Frequency Characteristics: Any one of four response characteristics, A, B, C, and 20 kc, can be selected by a panel switch.

The A, B, and C weighting positions are in accordance with American Standard Specification on sound-level meters (American Standards Association).

The C weighting provides uniform response to all frequencies within the range of the microphone. This characteristic is used for measuring high sound levels, for measuring sound-pressure levels, or when the instrument is used with an analyzer.

The 20 kc position allows the use of the complete frequency response of the sound-level meter's amplifier, which is flat from 20 c to 20 kc, so that complete use can be made of wide-range microphones such as the General Radio TYPE 1551-P1 Condenser Microphone Systems.

Microphone: The microphone is a high-quality Rochelle-salt-crystal diaphragm type. Condenser and dynamic microphones are available as accessories. See page 187.

Sound-Level Indication: The sound level is indicated by the sum of the readings of the meter and attenuator switch. The clearly marked, open-scale meter covers a span of 16 db with calibration from -6 to 10 db. The attenuator is calibrated in 10-db steps from 30 to 140 db above the standard reference level.

Output: An output of 1 volt across 20,000 ohms (when the panel meter is at full scale) is available at an output jack. The output can be used to drive frequency analyzers, recorders, and oscillographs.

Meter Damping: The panel meter is provided with two dif-

ferent damping characteristics, selected by a switch. In the FAST position, the meter ballistics agree with the current ASA standards. In the SLOW position, the meter is heavily damped and indicates, for easy reading, the average level of rapidly fluctuating sounds.

Calibration: Internal means are provided for standardizing the sensitivity of the electrical circuits in the sound-level meter. After standardization, the accuracy of sound-level measurements, as specified in ASA standards, is within ± 1 db for average machinery noise. The TYPE 1552-B Sound-Level Calibrator (page 189) is available for making periodic acoustic checks on the over-all calibration, including microphone.

Temperature and Humidity Effects: Readings are independent (within 1 db) of temperature and humidity over normal ranges of room conditions.

Power Supply: Two 1-1/2-volt size D flashlight cells (Rayovac 2LP or equivalent) and one 67 1/2-volt Burgess XX45 battery or equivalent, are supplied. The TYPE 1262-B Power Supply for ac operation is available.

Tube Complement: Four Raytheon CK-512-AX, two Raytheon CK-6418; one RCA 2N105 transistor.

Accessories Supplied: Telephone plug.

Accessories Available: See pages 186 to 191.

Cabinet: Shielded aluminum cabinet finished in gray crackle, which serves as a convenient and rugged carrying case. A leather carrying case is available, which permits operation of the instrument without removal from the case.

Dimensions: (height) 6 1/8 x (length) 9 1/4 x (width) 7 1/4 inches.

Net Weight: 7 pounds, 10 ounces with batteries; 9 pounds, 10 ounces including leather case.



The TYPE 1551-B Sound-Level Meter with the microphone in the storage position, and batteries automatically disconnected.



The Sound-Level Meter is being operated while in the leather carrying case and the microphone in the horizontal operating position.



The TYPE 1551-B Sound-Level Meter ac operated from the TYPE 1262-B Power Supply and the microphone in the vertical operating position.

Type		Code Word	Price
1551-B*	Sound-Level Meter	MIMIC	\$395.00
	Set of Replacement Batteries	MIMICADBAT	3.90
1262-B	Power Supply	MANLY	70.00
1551-P2	Leather Carrying Case	CALYX	20.00

*PATENT NOTICE. See Note 1, page x.





STANDARD ACCESSORIES FOR THE TYPE 1551-B SOUND-LEVEL METER

The following accessories are available for use with the TYPE 1551-B Sound-Level Meter to increase its field of application and to adapt

it for specialized types of measurement. These accessories can also be used with the older Sound-Level Meters, TYPES 759-B and 1551-A.

DYNAMIC MICROPHONE ASSEMBLY

TYPE 759-P25

For some measurements, particularly where a long cable must be used between microphone and meter, or where large ranges of temperature and humidity are encountered, a dynamic microphone is preferable. The TYPE 759-P25 Dynamic Microphone Assembly includes, in addition to the microphone, a 25-foot cable, an input transformer, and a tripod. The transformer plugs into the Sound-Level Meter in place of the standard microphone, and the microphone cable plugs into the transformer.

Microphone and transformer plug into the sound-level meter as shown.



SPECIFICATIONS

Sensitivity: Open-circuit output of typical microphone is 90 db below one volt per microbar, and of microphone plus transformer is 60 db below one volt per microbar. This sensitivity is satisfactory for use with the TYPE 1551-B, the TYPE 1551-A, and the TYPE 759-B Sound-Level Meters.

Direct Use with Analyzers: Microphone output can be supplied directly to the TYPE 1550-A Octave-Band

Noise Analyzer and the TYPE 760-B Sound Analyzer provided the level of the measured components is above 70 db (re 0.0002 μ bar), or to the TYPE 1554-A Sound and Vibration Analyzer, provided the level of measured components is above 50 db. (A TYPE 1552-B Sound-Level Calibrator is necessary to obtain absolute level.)

Maximum Safe Sound-Pressure Level: Sound-pressure levels above 140 db can damage the microphone.

Calibration: Output level is checked in our laboratories at several frequencies against a standard microphone that is calibrated periodically. The level at 400 cycles is supplied.

Cable Correction: No correction is necessary for the 25-foot cable supplied or the TYPE 759-P22 100-foot cable.

Accessories Supplied: One TYPE 1560-P94 Adaptor Cable Assembly.

Net Weight: 4 $\frac{5}{8}$ pounds.

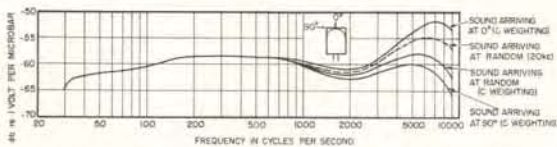

Typical response curves of TYPE 1551-B Sound-Level Meter with TYPE 759-P25 Dynamic Microphone Assembly.

Type		Code Word	Price
759-P25	Dynamic Microphone Assembly	NABOR	\$194.25
759-P22	Extra 100-foot cable	NASAL	30.00

Users who wish to replace the Sound Level Meter in their measuring systems with the TYPE 1551-B will need the TYPE 1560-P91 or

TYPE 1560-P94 Adaptor Assembly to connect their present accessory microphones to the new meter.

Type		For Use With	Code Word	Price
1560-P91	Adaptor Assembly	759-P35	ADAPTORANT	\$7.00
1560-P94	Adaptor Cable Assembly	759-P25 1551-P1L 1551-P1H	ADAPTORDOG	7.00



TYPE 1551-P1 CONDENSER MICROPHONE SYSTEMS

The TYPE 1551-P1L (for normal-level measurement) and the TYPE 1551-P1H (for high-level measurement) are condenser microphone systems designed for use with the TYPE 1551-B Sound-Level Meter for measuring sounds over wide frequency ranges. These microphones are not damaged by high sound levels or by high temperatures.

Applications include:

- Measurement of high-frequency, high-level noises produced by air streams, wood- and metal-working machinery, turbines, and jet engines.
- General-purpose sound-level measurements in locations where ambient conditions (temperature, sound-level) are severe.
- Measurements on high-fidelity sound reproduction systems over the full audio spectrum.

DESCRIPTION: TYPE 1551-P1L Condenser Microphone System uses a 21-BR-150 microphone and measures sound pressure level up to 155 db; TYPE 1551-P1H, which uses a 21-BR-180 microphone, measures levels up to 170 db.

The microphone base houses a subminiature



pre-amplifier tube. A battery-operated power supply, which fastens to the end of the Sound-Level Meter, provides pre-amplifier filament and plate power and polarizing voltage for the microphone. An extension cable, a tripod, and a leather carrying case are supplied.

SPECIFICATIONS

Frequency Response: 20 cycles to 18 kilocycles with either microphone. A typical response curve is shown below.

Calibration: The output level as a function of frequency is measured in our laboratory by comparison with a standard microphone that is calibrated periodically. The measured level at 400 cycles is supplied.

Direct Use with Analyzers: These assemblies can supply a signal directly to the TYPE 1550-A Octave-Band Noise Analyzer or the TYPE 760-B Sound Analyzer, provided that the level of the measured components is above 70 db (re 0.0002 microbar) for TYPE 1551-P1L, and 85 db for TYPE 1551-P1H, or to the TYPE 1554-A Sound and Vibration Analyzer, provided that the level of the measured components is above 50 db for TYPE 1551-P1L, and 65 db for TYPE 1551-P1H. (A TYPE 1552-B Sound-Level Calibrator is necessary for absolute level calibration.) An output is provided for this connection.

Maximum Sound-Pressure Level:

For the TYPE 1551-P1L Condenser Microphone Assembly, non-linear distortion is below 1% at levels up to 135 db, and less than 10% at 155 db.

For the TYPE 1551-P1H High-Level Microphone Assembly, non-linear distortion is below 1% up to 150 db and below 10% up to 170 db.

Minimum Measurable Sound-Pressure Level:

For the TYPE 1551-P1L: 50 db (re 0.0002 microbar).

For the TYPE 1551-P1H: 65 db (re 0.0002 microbar).

Temperature and Humidity: Maximum recommended operating temperature of the microphone in its probe is 212° F. The microphone is not damaged by exposure to high

humidity, but prolonged exposure may cause electrical leakage and render it temporarily inoperative.

Batteries: One 1½-volt size D flashlight cell (Rayovac 2LP or equivalent) and one 300-volt B battery (Eveready 493 or Burgess V-200) are supplied.

Tube Complement: Two Raytheon TYPE CK-512-AX.

Mounting: The microphone on its base plugs into one end of a 10-foot cable, which has a fitting with standard ¼-20 tripod thread. The other end of the cable is connected to the power supply unit, which fastens to one end of the Sound-Level Meter.

Accessories Supplied: One TYPE 1560-P94 Adaptor Cable Assembly.

Dimensions: Leather carrying case is approximately (height) 7 × (length) 5½ × (width) 8½ inches.

Net Weight: Complete in carrying case, 7 pounds, 6 ounces.

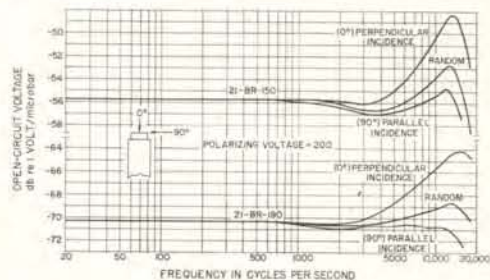

Type		Code Word	Price
1551-P1L	Condenser Microphone System	NONAL	\$340.00
1551-P1H	High-Level Microphone Assembly	NATAL	340.00
	Set of Replacement Batteries	NONALADBAT	11.20



VIBRATION PICKUP AND CONTROL BOX

The vibration pickup and control box plug into the sound-level meter in place of the microphone, as shown in the photograph above.

SPECIFICATIONS

Calibration: The db readings of the sound-level meter can be converted into absolute values of displacement, velocity, or acceleration by means of calibration data supplied.
Range: The range of measurement of the pickup and control box when used with the TYPE 1551-B, TYPE 1551-A or the TYPE 759-B Sound-Level Meter is approximately as follows:

Rms Displacement—30 micro-inches (minimum).

Rms Velocity—1000 micro-inches per second (minimum). The upper limit of velocity and displacement measurements is dependent on the frequency and is determined by the maximum acceleration permissible before non-linearity occurs (10 g).

Rms Acceleration—0.3 to 3900 in./sec/sec (10 g).

Accessories Supplied: One TYPE 1560-P91 Adaptor Assembly.
Net Weight: TYPE 759-P35 Vibration Pickup, 8 ounces (pickup only); pickup plus 7-foot cable and tips, 1 pound; TYPE 759-P36 Control Box, 1 pound, 13 ounces.

The TYPE 759-P35 Vibration Pickup is an inertia-operated crystal device which generates a voltage proportional to the acceleration of the vibrating body. By means of integrating networks in the control box, voltages proportional to velocity and displacement can also be delivered to the sound-level meter. The desired response is selected by means of a three-point switch on the control box.

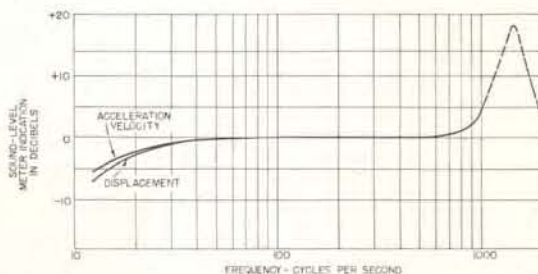

Over-all frequency response characteristic of the vibration pickup, control box, and sound-level meter for constant applied acceleration, velocity, and displacement, respectively.

Type		Code Word	Price
759-P35	Vibration Pickup	NOSEY	\$45.00
759-P36	Control Box	NANNY	65.00

TRIPOD AND EXTENSION CABLE

For measurements where the microphone must be located at a distance from the meter, the TYPE 759-P25 Dynamic Microphone is recommended (see page 187). However, a 25-foot extension cable and tripod for

mounting the Rochelle-salt crystal microphone can be supplied. With this cable a correction curve is furnished, giving the cable correction as a function of temperature of the microphone.

Type		Code Word	Price
1560-P34	Tripod and Extension Cable	KABLE	\$25.00

HANDBOOK

The *Handbook of Noise Measurement*, published by General Radio Company, covers thoroughly the measurement of noise and other airborne sounds. Authors are Dr. A. P. G. Peterson of the General Radio Engineering Staff and Dr. Leo L. Beranek, Lecturer at the Massachusetts Institute of Technology.

General Radio Engineering Staff, this section discusses vibration, its measurement, and analysis.

Copies of this handbook are available from the General Radio Company at a price of \$1.00 each, postpaid, in the United States and Canada.

A section of this handbook is entitled *The Measurement of Vibration*. Written by Ervin E. Gross, Jr., of the

A Primer of Noise Measurement presents a simpler discussion of sound measurement. Free copy available on request.





TYPE 1552-B SOUND-LEVEL CALIBRATOR

USES: The TYPE 1552-B Sound-Level Calibrator supplies a known acoustic signal for checking the over-all performance of sound-level meters, including the microphone. The calibrator is designed to fit over a number of microphones (see listing under specifications) and can also be used to calibrate the TYPE 1550-A Octave-Band Noise Analyzer, the TYPE 1554-A Sound and Vibration Analyzer, or the TYPE 760-B Sound Analyzer when they are used directly with these microphones. It can be used to supply an acoustic reference level for audio systems, provided one of the microphones listed or its equivalent is used.

The TYPE 1307-A Transistor Oscillator is designed to operate with the Sound-Level Calibrator and serves as both oscillator and level indicator.

DESCRIPTION: The calibrator has a small, stable loudspeaker mounted in one end of a cylindrical enclosure; the other end is open and fits over the microphone. Acoustical coupling between the speaker and the microphone is fixed by chamber and microphone dimensions. The calibrator provides acoustical shielding as well as a high test level to reduce effects of ambient noise during calibration. These conditions make calibration checks accurate and readily repeatable.

Calibrator fits over microphone as shown at right. At left is the TYPE 1307-A Transistor Oscillator.



SPECIFICATIONS

Input: 2.0 volts at 400 cycles across 600Ω; harmonic content must be 5% or less.

Microphones: The calibrator can be used on the following microphones without the need of special adaptors.

Shure Brothers, TYPE 98B99 (General Radio TYPE 1560-P1, supplied on TYPE 1551-B Sound-Level Meter).

Shure Brothers, TYPE 9898 (Supplied on 1551-A and 759-B Sound-Level Meters).

TYPE 1555-A Sound Survey Meter.

GR TYPE 759-P25.

GR TYPE 1551-P1L and GR TYPE 1551-P1H.

Western Electric TYPE 640-AA.

Kellogg Microphone.

Terminals: Input terminals are TYPE 938 Binding Posts spaced 3/4-inch to fit TYPE 274-MB Double Plug.

Accessories Required: A 400-cycle source, with output control and voltmeter. The TYPE 1307-A Transistor Os-

illator, a battery-operated device with self-contained voltmeter, is recommended (see page 107).

Dimensions: (length) 4 1/2 (diameter) 2 1/2 inches, over-all. **Net Weight:** 14 ounces.

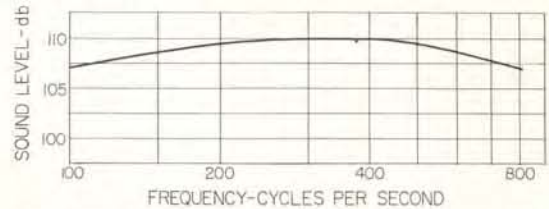

Frequency characteristic of the TYPE 1552-B Sound-Level Calibrator.

Type		Code Word	Price
1552-B	Sound-Level Calibrator	NATTY	\$52.50
1307-A	Transistor Oscillator (see page 107).....	OMEGA	85.00
1560-P31	Leather Carrying Case for calibrator and oscillator....	CANOE	10.00





TYPE 1550-A OCTAVE-BAND NOISE ANALYZER



USES: The Octave Band Noise Analyzer is used for the simple and rapid analysis of broad-band noises, where a knowledge of individual frequency components is not required.

It is particularly useful for:

- Noise measurements on aircraft, vehicles, and machinery;
- The analysis of environmental noise, as in offices and factories, where speech-interference level is important;
- Studies of environmental noise as related to hearing damage;
- Production testing and noise-level acceptance tests.

SPECIFICATIONS

Range: 20 cycles to 10,000 cycles in 8 bands,
 20 c to 75 c (low pass) 600 c to 1200 c
 75 c to 150 c 1200 c to 2400 c
 150 c to 300 c 2400 c to 4800 c
 300 c to 600 c 4800 c to 10,000 (high pass)

In addition, a band with a flat characteristic from 20 c to 10 kc is available at two switch positions for convenience in calibration against the sound-level meter.

Input Level: Between 1 and 10 volts for normal range. Levels below one volt reduce the range of reading; those higher than 10 volts overload the filters.

Input Impedance: 20,000 ohms. Input is isolated by a resistance pad, so that performance is independent of source if source impedance is constant over audio range or is small compared to 20,000 ohms.

Source: Sound-level meter supplying analyzer input must have low hum, low internal noise, and low distortion. The TYPE 1551-B Sound-Level Meter is recommended.

Direct Use with Microphone: The TYPE 1551-P1L and -P1H Condenser Microphone Systems or the TYPE 759-P25 Dynamic Microphone Assembly can be used if the band levels exceed 70 db, 85 db, and 70 db, respectively (re 0.0002 μ bar). A TYPE 1550-P1 Microphone Adaptor Plug

is also useful in studies of the acoustic characteristics of rooms and of materials.

DESCRIPTION: The Octave-Band Noise Analyzer is portable, battery-powered, and operates from the output of a sound-level meter, or, when the level is sufficiently high, directly from a microphone. It contains eight band-pass filters, any one of which can be selected by a switch; an attenuator; and an amplifier, which drives both an indicating meter and a monitoring output.

FEATURES:

- Movable reference dial on attenuator to facilitate reading.
- Monitoring output is provided.
- Meets A. S. A. standards.
- Operates from output of the TYPE 1551-B, the TYPE 1551-A or the TYPE 759-B Sound-Level Meter as well as other sound-level meters with outputs adequately free from noise and distortion.
- Can be used directly with microphone for high sound levels.
- Amplifier input jack permits amplifier to be used alone.
- A-C power supply can be substituted for batteries for laboratory use.
- Filters can be used alone for other types of measurements.

is required with the TYPE 759-P25 Dynamic Microphone Assembly.

Level Indication: Level is sum of meter and attenuator readings.

Attenuation: Except for the lowest and highest bands, at least 30-db attenuation is obtained at one-half the lower nominal cut-off frequency and twice the upper nominal cut-off frequency; at least 50-db attenuation is obtained at one-fourth the lower nominal cut-off frequency and at four times the upper nominal cut-off frequency. The 75-cycle low-pass filter has at least 30-db attenuation at 200 c and 50 db at 400 cycles. The 4800-cycle high-pass filter has at least 30-db attenuation at 2400 cycles and 50 db at 1200 cycles.

Accessories Supplied: Dial and dial clamp; shielded cable for connecting analyzer to sound-level meter.

Tube Complement: Three 1U4 and one 1T4.

Power Supply: Battery, Burgess 6TA60. Battery is included in price. For ac operation, TYPE 1261-A Power Supply (page 145) fits battery compartment.

Dimensions: (Width) 11 $\frac{5}{8}$ \times (height) 12 $\frac{1}{16}$ \times (depth) 9 inches, over-all.

Net Weight: 27 pounds including battery.

Type		Code Word	Price
1550-A	Octave-Band Noise Analyzer	ABEAM	\$535.00
	Replacement Battery for above	ABEAMADBAT	7.85
1550-P1	Microphone Adaptor Plug	MATOR	4.00
1261-A	A-C Power Supply	NUTTY	128.00





TYPE 1556-A IMPACT NOISE ANALYZER

The Impact Noise Analyzer evaluates the characteristics of impact-type sounds, which cannot be measured adequately by conventional noise-measuring equipment designed for steady-state measurements. Such noises include those produced by punch presses, forging hammers, fire-arms, pile drivers, office machinery and similar equipment. From the standpoint of hearing damage, these sounds constitute a serious problem for industry. They have hitherto been measurable only with complicated methods employing a cathode-ray oscillograph.

The two characteristics of impact sounds that seem most significant are the peak amplitude and the duration, or decay time. This analyzer measures both these quantities and, in addition, a quasi-peak value that is useful in determining the variation among peak values in repetitive impacts.

The Impact Noise Analyzer is designed to operate from the output of the TYPE 1551-B or the TYPE 1551-A Sound-Level Meter and, when the microphone on the sound-level meter is replaced by a vibration pickup (page 188), will evaluate the vibration impact characteristics of the device being studied.

DESCRIPTION: The Impact Noise Analyzer contains a battery-operated, degenerative, transistor amplifier, simultaneously driving



three ac voltmeter circuits, which consist of rectifiers, storage capacitors, and a common dc electronic voltmeter. The electrical storage system (a capacitor charged by a rectifier) makes it possible to measure three characteristics, the peak, quasi peak, and time average, of a single impact with only one indicating meter. Peak value is the maximum sound pressure level reached by the noise; quasi peak is a continuously indicating measure of the high sound-pressure levels reached just before the time of indication; and time average is a measure of the average level over a predetermined period of time, which, when subtracted from peak level is a measure of the time duration of the sound.

SPECIFICATIONS

Input: Any voltage between 1 and 10 volts for normal range. Inputs below 1 volt reduce the range of reading.

Input Impedance: Between 25,000 and 100,000 ohms, depending on the setting of the LEVEL control.

Frequency Range: 5 c to 20 kc.

Level Indication: Meter calibrated in decibels from -10 to +10. Attenuator switch increases range by 10 db.

Peak Reading: Rise time is less than 50 microseconds for a value within 1 db of peak value (for rectangular pulses). Storage time at normal room temperature is greater than 10 seconds for 1 db change in value.

Quasi Peak Reading: Rise time of less than $\frac{1}{4}$ millisecond and decay time of 600 ± 120 milliseconds for rectifier circuit.

Time Average Reading: Charge time of rectifier circuit selected by seven-position switch, having times of .002, .005, .01, .02, .05, .1, and .2 seconds for the resistance-capacitance time constant. Storage time at normal room temperature is greater than 1 minute for 1 db change in value.

Auxiliary Instruments Required: A sound-level meter or frequency analyzer to supply the analyzer input.

Input Terminals: Cord with phone plug at one end.

Batteries: One $1\frac{1}{2}$ -volt size D flashlight cell (Rayovac 2LP or equivalent) and one 45-volt B battery (Burgess XX30 or equivalent) are supplied.

Transistors: Three TYPE 2N105 or equivalents.

Tube Complement: One TYPE CK-6418.

Cabinet: Aluminum; carrying case supplied.

Mounting: May be fastened to one end of TYPE 1551-B Sound-Level Meter.

Dimensions: $7\frac{1}{2}$ inches (wide) \times $4\frac{1}{4}$ inches (deep) \times $6\frac{1}{2}$ inches (high).

Net Weight: $4\frac{1}{2}$ pounds; carrying case, 1 pound.

Photo at right shows how Impact Noise Analyzer attaches to Sound-Level Meter.



Type

1556-A | Impact Noise Analyzer

Code Word

MEDAL

Price

\$210.00

PATENT NOTICE. See Note 1, page x.





TYPE 1554-A SOUND AND VIBRATION ANALYZER



USES: The Sound and Vibration Analyzer is designed to measure the amplitude and frequency of the various frequency components in sounds or vibrations, in conjunction with a Sound-Level Meter or a Vibration Meter. It is useful for measurement not only of line (single-frequency) components but also continuous (noise) components of the spectrum. Its narrow bandwidth (8%, constant with frequency), is sufficient to embrace the frequency fluctuation arising from normal variations in speed of engines, machines, and appliances; the alternate, one-third-octave bandwidth (1.26:1) is used for the measurement of wide-band spectra. The TYPE 1521-A Graphic Level Recorder can be used to drive the analyzer dial and to record the spectrum of the input voltage wave.

Its high sensitivity, wide dynamic range, and 8% bandwidth make it also a useful general-purpose electric-wave analyzer for audio and sub-audio frequencies.

DESCRIPTION: The Sound and Vibration Analyzer is a tunable voltmeter whose bandwidth is a constant percentage of the center frequency. It is portable and battery powered. It consists of two RC-tuned selective ampli-

fiers, connected in cascade, and input and output circuits. The selective amplifiers can be synchronously or stagger-tuned to give "NARROW" or "ONE-THIRD OCTAVE" bandwidth respectively. They also can be switched to non-selective (ALL-PASS) operation for convenient measurement of the entire input signal before analysis into its components. The ac output signal is available at a jack on the panel for connection to headphones or to a recorder. A special chart, CTP-554 is available for use with the TYPE 1521-A Graphic Level Recorder for recording the output of the analyzer at frequencies above 25 c/s.

FEATURES:

- A Sound Analyzer and a Vibration Analyzer combined in one instrument.
- Wide frequency range, 2.5 to 25,000 cycles.
- 10 to 1 span on each range.
- Adjustable bandwidth: "NARROW", "ONE-THIRD OCTAVE", or "ALL-PASS".
- Adjustable decibel dial may be set so analyzer is direct-reading in sound-pressure level, one-third octave band level, etc.
- Portable and battery powered.
- Can be calibrated for amplitude using a 115-volt, 60-cycle power line.
- Output jack for connection to headphones or recorder.
- Response falls off far from selected frequency at 12-db per octave.
- "Trap door" provides easy access to batteries when replacement is necessary.
- NARROW bandwidth response is 8% wide, 3-db down, allowing easy measurement of signals having "wow", yet has 40-db discrimination at one octave from the selected frequency.

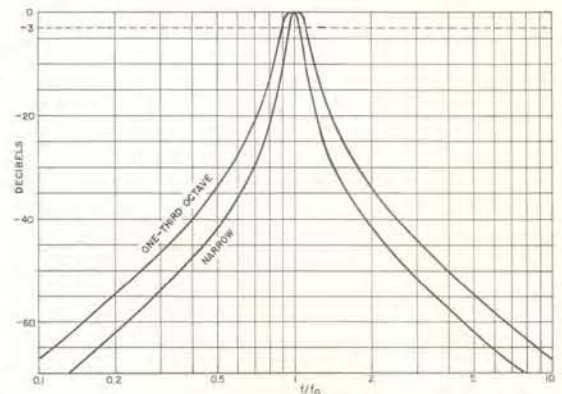

Typical bandwidth curves for the TYPE 1554-A Sound and Vibration Analyzer.





SPECIFICATIONS

Frequency Range: From 2.5 to 25,000 cycles in four ranges. The FREQUENCY dial is calibrated from 2.5 to 25 cycles; the FREQUENCY MULTIPLIER switch has four positions, 1, 10, 100, and 1000.

Frequency Calibration Accuracy: ±2% of the frequency dial settings.

Input Voltage Range: 100 microvolts to 30 volts for useful indication. Most sensitive range is 1 millivolt full scale.

Frequency Response: "NARROW": Maximum response is flat ±2 db over the entire tuning range. "ONE-THIRD OCTAVE": Maximum response is flat ±4 db over the entire tuning range. With respect to the "ALL-PASS" response, the effective bandwidth for noise is one-third octave ±2 db. "ALL-PASS": Flat from 2.5 cycles to 25 kilocycles ±2 db.

Bandwidth: "NARROW": (See plot) Response is down 3 db at ±4% of selected frequency. At one-half and twice selected frequency, response is down more than 40 db. "ONE-THIRD OCTAVE": (See plot) bandwidth is 1.26:1 at the 3 db points. At one-half and twice the selected frequency, the response is down more than 30 db. Input Impedance: 100 kilohms, unbalanced. Low input terminal grounded to case.

Direct use with Microphone:

Microphone Type Component Levels Must Exceed
759-P25* 50 db re 0.0002 microbar

1551-P1L 50 db re 0.0002 microbar
1551-P1H 65 db re 0.0002 microbar

Meter: Three ranges, -10 to +10 decibels, 0 to 3 volts, and 0 to 10 volts.

Attenuator: Adjustable in 10-db steps.

Output: Jack on front panel provides approximately 1 volt, open circuit, when meter indicates full scale. Output impedance, 5 kilohms.

Tubes: Four CK512AX and two CK526AX.

Transistors: Four 2N169A, five 2N321, and two 2N324.

Batteries: Four 1.5 volt (Eveready No. 935 Size C or equivalent), and two 67.5-volt (Eveready No. 467 or equivalent). Batteries are supplied with instrument. Life of batteries approximately 100 hours. A BATTERY CHECK position on the OFF-ON switch connects the panel meter to indicate when the batteries are satisfactory or need to be replaced.

Accessories Supplied: Shielded cable-and-plug assembly for connection to Sound-Level Meter. Plugs to fit input and output jacks. Cable-and-plug assembly for calibration using 115-volt line. Pouch for accessories. Airplane-luggage-type carrying case.

Dimensions: 10 5/8 x 15 3/8 x 11 1/2 inches, over-all.

Weight: 31 1/2 pounds without accessories or carrying case; 39 3/4 pounds with accessories and carrying case.

*Type 1550-P1 Adaptor Plug required (see page 190).

Table with 4 columns: Type, Description, Code Word, Price. Row 1: 1554-A, Sound and Vibration Analyzer, DRAMA, \$1060.00. Row 2: Set of Replacement Batteries, DRAMAADBAT, 7.80.

Available for delivery after September 1, 1959. In the meantime the analyzers listed below are still available.

TYPE 760-B SOUND ANALYZER

A continuous spectrum instrument with a constant percentage bandwidth, this analyzer is recommended for the analysis of pitched sounds. It is also a useful general-purpose wave analyzer. Consists of a 3-stage, direct-coupled amplifier with a tunable null circuit

in a negative feedback loop. Battery powered and portable.

Frequency Range: 25 to 7500 cps in five ranges.

Accuracy: ±1.5% or ±1.5 cps, whichever is larger.

Input: 1 mv to 10 volts into 20 to 30 kΩ.

Frequency Response: ±2 db over entire range.

Bandwidth: 2%; down 3 db at 1% off peak.

Dimensions: 18 x 10 x 11 1/2 inches, over-all.

Net Weight: 36 1/2 pounds, including batteries.



TYPE 762-B VIBRATION ANALYZER

Intended primarily for use with the Type 761-A Vibration Meter, but can also be used for general harmonic analysis of very-low-frequency voltages in the laboratory. Similar in performance, construction, operation, and appearance to the Type 760-B Sound Analyzer.

Frequency Range: 2.5 to 750 cps in five ranges.

Bandwidth: Sharp selectivity, down 3 db at 1% off peak.

Broad selectivity, down at least 3 db at 5% off peak.

Table with 4 columns: Type, Description, Code Word, Price. Row 1: 760-B, Sound Analyzer, ATTAR, \$520.00. Row 2: 762-B, Vibration Analyzer, AWARD, 585.00. Row 3: Set of Replacement Batteries, ATTARADBAT, 16.15.





TYPE 761-A VIBRATION METER

USES: Vibrations in machines and structures can be measured quickly and easily with this instrument. For the manufacturer of machinery and equipment, the TYPE 761-A Vibration Meter is extremely useful in research, design, and production testing. Maintenance engineers will find it useful for checking the operating condition of bearings, gear trains, and other mechanisms. Excessive vibrations due to improper adjustment or to structural resonances can be located and measured.

Its excellent low-frequency response permits the study of the operation of belt drives and of the effectiveness of mountings designed to reduce vibrations in adjacent structures.

A frequency analysis of the measured vibration can be made with the TYPE 1554-A Sound and Vibration Analyzer (page 192).

DESCRIPTION: The TYPE 761-A Vibration Meter consists of: an inertia-operated, Rochelle-salt, crystal pickup, which delivers a voltage proportional to the acceleration of the vibratory motion; an adjustable attenuator; an amplifier; and a direct-reading indicating meter. An integrating network can be switched to convert the output of the vibration pickup

to a voltage proportional to either displacement or velocity.

The Vibration Meter reads directly in root-mean-square inches, inches per second, and inches per second per second.

Accessories include various tips and an eight-inch metal probe for the pickup to facilitate measurements in normally inaccessible places. Available at additional cost is the TYPE MAP-2-S1 Permanent-Magnet Clamp, which replaces the probe or tip when measurements are taken under conditions where hand-held operation would not be satisfactory. The accompanying illustration shows the magnetic clamp in use.

FEATURES:

- Portable and self-contained.
- Easy to operate.
- Direct reading.
- Low-frequency response down to 2 cycles per second.
- Independent output system for panel meter and output jack.
- Semi-logarithmic meter scale permits wide range of measurement with a single multiplier setting.



SPECIFICATIONS

Ranges: The vibration meter is direct reading in the following ranges:

Displacement: 16 micro-inches to 30 inches, rms.
Velocity: 160 micro-inches per second to 300 inches per second, rms.

Acceleration: 0.160 inch per second per second to 3900 inches per second per second, rms. (0.0004g to 10g).

Response Characteristics: The response follows the theoretical curves shown below within the following tolerances.

Table with 4 columns: Quantity, Range, Tolerance, and Frequency Range. It lists specifications for Acceleration, Velocity, and Displacement across different frequency ranges.

Above 500 cps the error increases and may reach +30% at 1000 cps. This is caused by the differences in response of individual pickups near resonance.

Pickup Unit: Inertia-operated, Rochelle-salt-crystal type. Output of pickup is 0.800 volts per g. Non-linearity occurs at 10 g or 3900 inches per second per second.

Meter: Scale reads directly in the quantity being measured—root-mean-square micro-inches for displacement, root-mean-square micro-inches per second for velocity, and root-mean-square inches per second per second for acceleration.

Attenuators: A 10-step attenuator changes the meter scale range by a factor of 30,000 to 1. Additional multipliers indicate the correct units of measurement and multiplying factors for each response characteristic.

Calibration: Connection to any a-c power line makes it possible to check the over-all calibration excluding pickup.

Terminals: A jack is provided on the panel for plugging in a pair of head telephones in order to listen to the vibrations being measured, for connecting the TYPE 762-B Vibration Analyzer, or for connecting a cathode-ray oscillograph.

Tube Complement: Two CK-512-AX, two 1N5-GT and one 1D8-GT are required.

Battery: A single self-contained battery unit, (Burgess 6TA60 or equivalent), which supplies the necessary plate and filament voltages, is included.

Accessories Supplied: TYPE 761-P1 Vibration Pickup, power cable for calibration check, spare pilot lamp, and plug for output jack.

Case: Shielded carrying case of airplane-luggage construction.

Dimensions: (Height) 12 1/2 inches x (length) 13 1/2 inches x (width) 9 1/2 inches.

Net Weight: 22 3/4 pounds with battery; 17 1/4 pounds without battery.

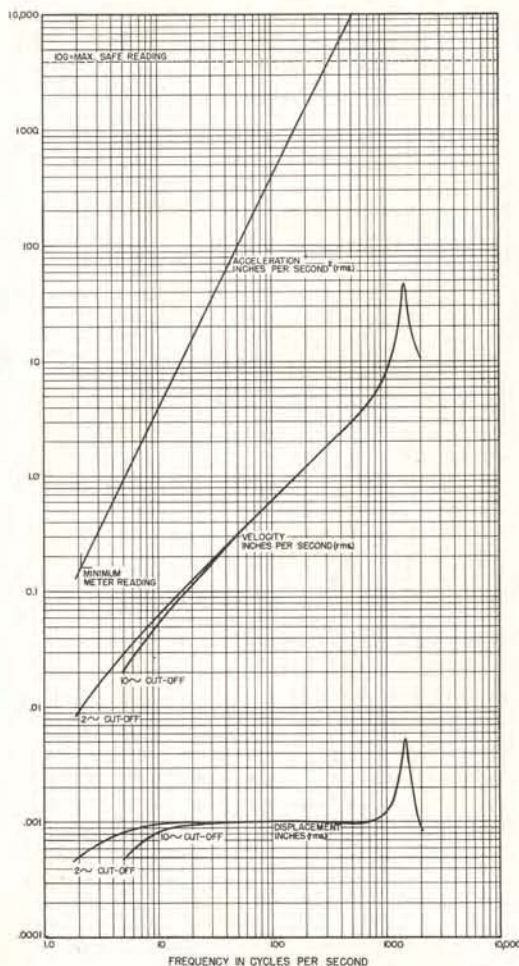

(Left) Vibration pickup held in place by the TYPE MAP-2-S1 Permanent-Magnet Clamp.

(Right) Readings of the Vibration Meter as a function of frequency for a constant displacement of 0.001 inch (rms).

Table with 4 columns: Type, Description, Code Word, and Price. It lists items like Vibration Meter, Replacement Pickup, Replacement Battery, and Permanent-Magnet Clamp with their respective code words and prices.

*Give instrument serial number when ordering.





STROBOSCOPES

THE STROBOSCOPE permits rotating or reciprocating objects to be viewed intermittently and produces the optical effect of slowing down or stopping motion. For instance, an electric fan revolving at 1800 rpm will apparently be stationary if viewed under a light that flashes uniformly 1800 times per minute. At 1799 flashes per minute, the fan will appear to rotate at 1 rpm, and, at 1801 flashes, it will appear to rotate backward at 1 rpm. Because the human eye retains images for an appreciable fraction of a second, no flicker is seen except at very low speeds. The apparent slow motion is an exact replica of the original higher-speed motion, so that the motion of a high-speed machine can be analyzed under normal operating conditions.

When the flashing rate of the light is adjustable, the control can be calibrated in flashes (or revolutions) per minute. The stationary image that is seen when the flashing rate of the lamp and the rotational rate of a shaft are equal permits very precise speed measurements to be made.

General Radio stroboscopes are electronic-flash devices, in which the flash duration is very short, of the order of a few millionths of a second, which allows very rapid motion to be arrested.

The STROBOTAC® is a compact, portable, stroboscopic tachometer that operates from the a-c power line, and is capable of speed measurements to better than 1%. It is equally useful for slow motion studies. Because there is no mechanical connection between tachometer and machine, no power is absorbed by the tachometer. Therefore, speed measurements can be made on very low-power mechanisms and on production equipment such as spindles on a textile spinning frame, motors, and other

machines. With the STROBOTAC, a number of such machines can be checked for uniform and correct speed, nearly as easily as one can aim an ordinary flashlight.

For applications where a brighter light is desired, the STROBOLUX® can be added. Its flashing rate is controlled by the STROBOTAC. Another auxiliary light source, the STROBOLUME, emits a very-high-intensity flash that is particularly useful for viewing low-speed machines, such as looms and printing presses. The STROBOLUME has sufficient brilliance for use in high-speed photography.

The Contactor is a device for attachment to a rotating shaft to flash a stroboscope once for each revolution. The Contactor permits absolute synchronism with a shaft which may be constantly varying in speed. A phasing control is provided to permit flashing of the light at any point in the 360° rotation of the shaft.

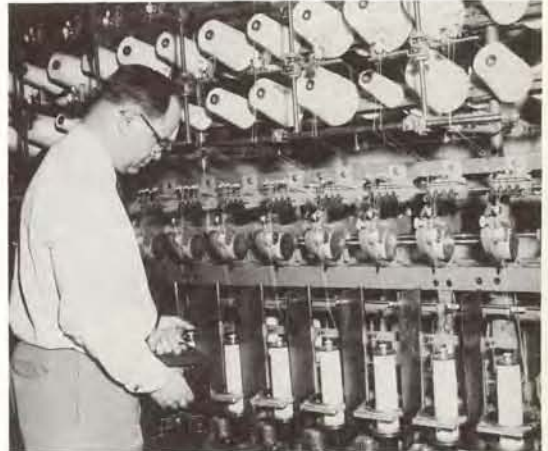

TYPE 631-BL Strobotac® used to compare actual spindle speed to calculated speed and to check any speed variation between spindles.

The characteristics of the light output from General Radio Stroboscopes are tabulated below:

<i>Instrument</i>	<i>Flashes per Second</i>	<i>Peak Light* Mega candlepower</i>	<i>Flash Duration** Microseconds</i>	<i>Beam Horizontal*** Candlepower seconds</i>	<i>Page</i>
Strobotac	50 to 240	0.02	10	0.2	197
	10 to 60	0.03	40	1.2	
Strobolux	10 to 100	.2	15	3.0	198
	1 to 60	.35	24	8.4	
	Single Flash	1.8	42	75.5	
Strobolume	10 to 50	0.14	10	1.4	199
	0 to 10	10	30	300	

*Approximate value for lowest frequency shown.

**Approximate value based 1/5 peak light value.

***Product of previous two columns.

Contactors—see page 200.





TYPE 631-BL STROBOTAC® STROBOSCOPIC TACHOMETER

USES: Wherever machines operate, there are uses for the STROBOTAC—in the design laboratory, in production maintenance, and in the repair shop. Use it:

- for the slow-motion observation of
 - Cams
 - Pulleys
 - Governors
 - Gears
 - Fans
 - Linkages
 - Pawls
 - Sprockets
 - Chains
- and other machine elements
- for the rapid alignment of close-tolerance mechanisms in production
 - for calibrating tachometers in aircraft
 - for measuring the speed of Motors
 - Production machines (textile spindles, etc.)
 - Small, low-power devices
 - Machines in underload and overload tests
 - Any repetitive motion that can be seen, even if mechanically inaccessible

DESCRIPTION: The STROBOTAC includes, in one compact unit, a strobotron lamp in a parabolic reflector, an electronic pulse generator to control the flashing rate, and a power supply operating from the a-c power line. The flashing rate is adjusted by a large knob (see photo), and the corresponding speed in rpm is indicated on an illuminated drum dial on the top face of the unit. The flashing rate can also be controlled from an external generator or contactor, or from the a-c power line.

The normal speed range is from 600 to 14,400 rpm. An additional low range extends down to 60 rpm. Speeds above 14,400 can be measured by using flashing rates that are simple submultiples of the speed to be measured.

At speeds of 600 rpm and below, flicker be-



comes pronounced, because the human eye cannot retain successive images long enough to create the illusion of continuous motion. This flicker, and the low average level of illumination, set 600 rpm as the lower limit of speeds for which the STROBOTAC is recommended for slow-motion studies. For lower speeds, use the STROBOTAC to flash the STROBOLUME, page 199, which produces a high-intensity flash.

For more light at speeds above 600 rpm, use the STROBOLUX.

FEATURES:

- Small, compact.
- Short flash—gives sharp images.
- High accuracy.
- Requires no contact with machine—absorbs no power.
- Easy to set—easy to read.

SPECIFICATIONS

Range: 600 to 14,400 rpm on dial in two ranges, 600 to 3600 rpm and 3600 to 14,400 rpm; useful at speeds up to 100,000 rpm. Additional low range of 60 to 1440 rpm (1/10 scale values) for flashing the STROBOLUME.

Accuracy: ±1% of scale reading above 900 rpm on normal (600 to 14,400) range when scale is standardized in terms of a frequency-controlled power line.

Flash Duration: 10 to 40 microseconds.

Peak Light: 0.02 to 0.03 megacandlepower.

Power Supply: TYPE 631-BL, 105 to 125 volts, 60 cycles. 50-cycle models are available as listed below.

Power input receptacle will accept either 2-wire (TYPE CAP-35) or 3-wire (TYPE CAP-15) power cord. Two-wire cord is supplied. For 3-wire, see page 237.

Power Input: 35 watts, maximum.

Tube Complement: One TYPE 631-P1 Strobotron, one 6X5-GT/G, and one 6N7-GT/G.

Accessories Supplied: TYPE CAP-35 seven-foot power cord, plug to fit contactor jack, spare fuses.

Mounting: Metal cabinet with handle.

Dimensions: 7 7/8 x 9 x 10 inches, over-all; lens dia., 5 inches.

Net Weight: 9 1/2 pounds.

Type		Power Supply	Code Word	Price
631-BL	Strobotac®	105-125 volts, 60 cycles	BRUIN	\$170.00
631-BLS3	Strobotac®	105-125 volts, 50 cycles	BRUINPASHA	180.00
631-BLS8	Strobotac®	210-250 volts, 50 cycles	BRUINREGAL	180.00
631-P1	Replacement Strobotron		SENNA	8.50

PATENT NOTICE. See Note 6, page x.





USES: The STROBOLUX is a white-light source for use with the STROBOTAC in applications

TYPE 648-A STROBOLUX®

AUXILIARY LIGHT SOURCE

where the areas to be illuminated are larger than the STROBOTAC can cover, or where greater light intensity is required. Although its flash is not so short as that of the STROBOLUX (page 199), it can be used as a light source for single-flash photography.

DESCRIPTION: TYPE 648-A STROBOLUX consists of a power supply and lamp, capable of producing brilliant light flashes at speeds up to 6000 per minute. The triggering source is a STROBOTAC, which can be externally controlled if desired.

The lamp furnishes a brilliant white light whose intensity is between ten and one hundred times that of the STROBOTAC.

SPECIFICATIONS

Range: From single flashes to 6000 per minute.
Duration of Flash: Between 15 and 50 microseconds, depending upon flashing speed and the setting of the SPEEDS range switch. The shorter flash is obtained at the higher speeds.
Peak Light: 1.8 megacandlepower at single flash; 0.2 Mcp at 6000 flashes per minute.
Guide Number: The guide number (distance in feet x aperture) for single flash photography is approximately 20 with a film speed of 100 (ASA).
Power Supply: 105 to 125 (or 210 to 250 volts), 50 to 60 cycles.
Power Input: 125 watts, maximum.

Tube Complement: One 5Z3 Rectifier and one TYPE 648-P1 Lamp.

Mounting: Sheet-metal case with black wrinkle finish. Lamp and its 9-inch reflector are mounted in one side of case, the power supply in the other. The removable lamp assembly has a 1/4 x 20 tripod thread and connects to power supply through a 9-foot cable.

Accessories Required: A STROBOTAC is necessary to operate the STROBOLUX.

Accessories Supplied: TYPE CAP-35 seven-foot power cord, cable for STROBOTAC connection, spare fuses.

Dimensions: 13 3/4 x 11 5/8 x 13 3/4 inches, over-all; lens diameter, 8 1/4 inches.

Net Weight: 31 3/4 pounds.

Type		Code Word	Price
648-A	Strobolux®	SCALY	\$300.00
648-P1	Replacement Lamp	SURLY	20.00

PATENT NOTICE. See Note 6, page x.

Light and compact, the STROBOTAC is easily held in one hand, while the flashing rate is adjusted by the other hand.



View of STROBOLUX and STROBOTAC. Cable for interconnections is furnished. STROBOLUX lamp is removable for use at end of a nine-foot cable.





TYPE 1532-B STROBOLUME HIGH-INTENSITY LIGHT SOURCE



USES: The STROBOLUME produces a brilliant, white, light flash that is well suited for studying motions of machines operating at relatively low speeds. Two important applications are the analysis and adjustment of shuttle motion in textile looms and of color register in printing.

The STROBOLUME is designed to be flashed from an external contactor, such as the TYPE 1535-B (page 200), and hence is particularly useful where the motion to be examined is related to angular position of a shaft, such as a crankshaft, camshaft, or countershaft, on one end of which a contactor is held or clamped. It can also be flashed from a STROBOTAC. It is adaptable as a light source for single- and multiple-flash photography in research projects, where the motion of the subject is often too fast to be stopped by conventional "speedlights."

DESCRIPTION: The elements of the STROBOLUME are a high-voltage transformer and rectifier; a capacitor, which is charged to about 2500 volts from the rectifier; and a lamp through which the capacitor is dis-

charged to produce the flash. The discharge is initiated by a special strobotron tripped by an external impulse. Either of two values of capacitance can be used, as selected by a switch. The larger is for flashing rates up to 1200 per minute with intense light for short periods, the smaller for rates up to 3000 with about 1/20th as much light. The entire assembly is mounted in a small metal case with handle.

FEATURES:

- Brilliant, high-intensity, short white flash.
- Overload breaker prevents overheating.
- Compact, light, portable assembly.
- Lamp assembly is removable and has a 14-foot extension cable.
- Lamp housing has tripod thread.
- Long-life sealed-beam lamp easily replaced.

SPECIFICATIONS

Flashing Speed Range: High intensity—continuous, 60 flashes per minute, maximum; intermittent, or for short periods, up to 1200 per minute. Low intensity—continuous up to approximately 3000 per minute.

Peak Light: 10 megacandlepower at 60 flashes per minute; 0.14 mcp at 3000 fpm.

Duration of Flash: Approximately 30 microseconds with intensity switch at HIGH; approximately 10 microseconds with switch at LOW.

Guide Number: The guide number (distance in feet x aperture) for HIGH intensity is approximately 25 with fast film speed of 100 (ASA).

Flashing Control: TYPE 1535-B Contactor or TYPE 631-BL Strobotac with TYPE 1532-P2 Transformer Cable.

Tube Complement:

- 1 Rectifier—TYPE 816
- 1 Strobotron—TYPE 0A5
- 1 Flash Lamp—TYPE 1532-P1 (GE TYPE FT-220)

Accessories Supplied: Power cord with ground terminal, flash control cord with push button, and a plug to which a contactor can be connected.

Other Accessories Required: None, if lamp is to be flashed manually by push button. For stroboscopic work, a TYPE 1535-B Contactor, or a TYPE 631-BL STROBOTAC with TYPE 1532-P2 Transformer Cable is needed.

Mounting: Metal case; lamp is removable; storage space for lamp cable is provided in case. Lamp housing has tripod socket with 1/4 x 20 thread.

Power Supply: 105 to 125 volts, 50 to 60 cycles or 210 to 230 volts, 50 to 60 cycles; see price list below.

Power Input: At HIGH intensity, 105 watts at 60 flashes per minute; 500 watts at 1200 flashes per minute. At LOW intensity, 120 watts at 3000 flashes per minute.

Dimensions: 13 x 7 1/2 x 11 1/2 inches, over-all; lamp unit, 6 inches diameter x 5 3/4 inches.

Net Weight: 18 1/2 pounds. Lamp unit, only, 2 pounds.

Type		Code Word	Price
1532-B	Strobolume, 105-125 volts, 50 to 60 cycles	TITLE	\$275.00
1532-P1	Replacement Lamp	TOWEL	25.00
1532-P2	Transformer-Cable (Length: 7 feet)	TULIP	15.00
1532-BQ18	Strobolume, 210-250 volts, 50 to 60 cycles	TITLEREPEL	300.00

PATENT NOTICE. See Note 6, page 8.





TYPE 1535-B CONTACTOR

USES: The TYPE 1535-B Contactor is a control and coupling device for synchronizing a stroboscope with a rotating shaft, so that motion can be observed as a function of shaft angle. It is particularly useful in the examination of relatively low-speed machinery with the TYPE 1532-B STROBOLUME, in such applications as the timing of loom shuttles and the adjustment of register in printing. It can be used equally well with the STROBOTAC or with the combination of STROBOTAC and STROBOLUX, at speeds up to 5000 rpm.

DESCRIPTION: The elements of the contactor are the electrical contacts, the phasing system, and the mechanical coupling system.

The electrical contact system comprises an accurately rotating cam and a low-inertia

breaker arm. One contact is made for each revolution of the drive shaft.

The phase-adjusting system permits a 360-degree adjustment of the contacts with respect to the rotating shaft. The relative position of the contacts is shown on a scale graduated in 5-degree intervals. The scale can be set to zero with no change in the contact setting. This is particularly useful for making timing studies. Two phasing adjustments are provided; one is located on the contactor body, and the other is at the end of a detachable ten-foot flexible shaft.

The mechanical coupling system consists of an 18-inch flexible shaft, whose free end terminates in a powerful, multipole, Alnico magnet with spring-loaded centering device, which assures positive drive from a centered steel or iron shaft without need for drilling and tapping the shaft.

The entire assembly is mounted on a sturdy four-foot rod secured in a sturdy, cast-iron base, 18 inches in diameter. The contactor may be located at any point on this rod and is locked in position by a thumbscrew.

FEATURES:

- Can be easily attached and removed from machine while in motion.
- Remote phase-control shaft is removable.
- Ball bearings are used on rotating parts.
- Flexible drive coupling shaft can be bent through 90° angle for work in crowded locations.
- Auxiliary coupling devices are furnished for permanent coupling to shaft, or where shaft is non-magnetic.
- Contactor can be removed from stand and mounted permanently on machine.

SPECIFICATIONS

- Speed Range: 0 to 5000 rpm.
- Contacts per Revolution: One
- Range of Phase Adjustment: 360°
- Range of Height Adjustment: 6 inches to 4 feet
- Diameter of Base: 18 inches
- Accessories Supplied: Auxiliary coupling devices for connection to shaft in which hole has been drilled.
- Other Accessories Required: When the contactor is used with a STROBOTAC, the TYPE 1535-P1 Adaptor Cable is needed for connection to the STROBOTAC.
- Net Weight: 19¾ pounds.

Type		Code Word	Price
1535-B	Contactor	CROOK	\$150.00
1535-P1	Adaptor Cable	CROOKCABLE	6.00

PATENT NOTICE. See Note 6, page x.



UNIT INSTRUMENTS



General Radio Unit Instruments are electronic building blocks for the laboratory. Their compact, rugged construction makes them equally useful for production-line testing. They are simple, inexpensive, high-quality, high-performance units that can be used individually or combined to form more elaborate systems.

Uniformity of cabinet and power supply design permit economies in manufacture, without sacrifice of performance, utility, or quality.

The purpose of the Unit line is to make available to laboratories at a reasonable price, simple, basic instruments that are needed for everyday work. These Units are particularly suitable for the educational laboratory,

where they are not only easy to fit into the budget, but help the student to see an elaborate system as a combination of simpler component apparatus.

FEATURES:

- Laboratory accuracy.
- Low cost.
- Reliable.
- Versatile, with 874 Coaxial Elements.
- Add-a-unit flexibility.
- Compact construction.
- Simple to operate.
- Can be relay-rack mounted.

OSCILLATORS



TYPE 1214-A



TYPE 1210-C with TYPE 1203-B



TYPE 1215-B



TYPE 1218-A

TYPE 1214 UNIT OSCILLATORS

Compact, efficient, single-frequency and two-frequency units, operating directly from the ac line—excellent as modulating oscillators and bridge generators. Four models: 120 c, 400 and 1000 c, 270 and 1000 c, 1 Mc. See page 112

TYPE 1210-C UNIT RC OSCILLATOR 20 c to 500 kc

General purpose—sine-wave outputs, 50 to 1250, and 14,000 ohms—square-wave output, 2500 ohms, 13 μ sec rise time—max. output, 2 watts—precision drive—requires Unit Power Supply. See page 110

HF, VHF, UHF OSCILLATORS

These six oscillators cover frequencies continuously from 0.5 to 2000 Mc. Compact, low-priced units of adequate power, with single-dial precision drive, they are equally useful in the laboratory and in production test-

ing. Coaxial output for 50-ohm loads. Designed for use with Unit Power Supplies. See pages 114 and 115

Type 1211-B Unit Oscillator	0.5–50 Mc
Type 1215-B Unit Oscillator	50–250 Mc
Type 1208-B Unit Oscillator	65–500 Mc
Type 1209-BL Unit Oscillator	180–600 Mc
Type 1209-B Unit Oscillator	250–920 Mc
Type 1218-A Unit Oscillator	900–2000 Mc

TYPE 1220-A UNIT KLYSTRON OSCILLATOR —2700 to 7425 Mc.

Power source for measurements—eight separate reflex klystron tubes with self-contained cavities to cover range—amplitude modulation: internal 1000-cycle square wave—square wave or pulse from TYPE 1210-C or TYPE 1217-A—frequency modulation or sweep: sine-wave from TYPE 1214-A, TYPE 1210-C, or 60 c line—operates from Unit Power Supply—75 mw, max. output. See page 116

PULSE AND STANDARD-FREQUENCY GENERATORS

TYPE 1213-C FREQUENCY/TIME CALIBRATOR

Secondary frequency standard—includes stable crystal, multivibrator, heterodyne detector, pulse amplifier—produces harmonics for calibration up to 1000 Mc—also pulses for scope calibration—requires Unit Power Supply. See page 86

TYPE 1217-A UNIT PULSER

Compact, versatile pulse generator—pulse duration 0.2 to 60,000 μ sec—rise time, 0.05 μ sec—internal repetition rates, 30 c to 100 kc—square waves at any frequency in range—output 20 volts—external drive, if desired—output impedance, 200 Ω for positive pulses, 1500 Ω for negative—requires Unit Power Supply. See page 122

TYPE 1213-C
with TYPE 1201-B



TYPE 1219-A UNIT PULSE AMPLIFIER

Over 500 ma load current available—output impedance, 50 to 150 Ω for positive pulses, 50 to 430 Ω for negative—driving voltage, 30 v negative, 2.5 v positive—max. pulse duration, negative drive, 2000 μ sec; positive, 10,000 μ sec—duty ratio 0.1 and 0.5—rise and decay time, 0.04 μ sec—built-in power supply. See page 123





AMPLIFIERS AND DETECTORS



TYPE 1206-B with TYPE 1203-B



TYPE 1216-A



TYPE 1212-A with TYPE 1203-B

TYPE 1206-B UNIT AMPLIFIER

Single-ended push-pull circuit—output 3 watts, 20 c to 50 kc; 1.5 watts 10 c to 100 kc; 0.5 watt at 250 kc—output impedance, 600 Ω—less than 1% harmonic distortion—dröop in 30-c square wave, 15% open circuit; rise time, 1 μsec, open circuit—max. gain 34 db—requires Unit Power Supply. See page 68

TYPE 1212-A UNIT NULL DETECTOR

Sensitive, wide-frequency range, logarithmic voltage indicator for use as null detector in ac bridge measurements—less than 40 μv for 1% deflection at 1 kc—range

30 c to 5 Mc—on-scale range of 120 db—requires Unit Power Supply. See page 63

TYPE 1216-A UNIT I-F AMPLIFIER

30-Mc i-f amplifier with 0.7 Mc pass band—2 μv sensitivity—accurately calibrated attenuator and meter—80 db range—for use with crystal mixer and Unit Oscillator, as indicator in heterodyne-type null detector from 50 Mc to 5000 Mc—also to measure relative signal levels, attenuation, TV transmitter harmonics, crosstalk, etc. Has own 115 v, 60 c power supply which can also supply companion Unit Oscillator. See page 65

POWER SUPPLIES



TYPE 1203-B



TYPE 1205-B

TYPE 1203-B UNIT POWER SUPPLY

Recommended for use with most Unit Instruments, unless more specialized uses require one of the other supplies—300 volt d-c, up to 50 ma—6.3 v a-c, 3 amp—operates from 115 v, 60 c. See page 143

TYPE 1201-B UNIT REGULATED POWER SUPPLY

Plugs into Unit Instrument—supplies 6.3 v ac at 3 amp; 300 volts regulated dc up to 50 ma—operates from 115 v, 50 to 60 c. See page 143

TYPE 1204-B UNIT VARIABLE POWER SUPPLY

Includes Variac® Autotransformer for adjusting plate voltage—panel meter indicates ac output voltage and current—0 to 300 v dc at 100 ma; 6.3 v ac at 3 amp—output available at binding posts as well as multipoint connector. See page 143

TYPE 1205-B ADJUSTABLE REGULATED POWER SUPPLY

DC output adjustable from 0 to 300 volts at 200 ma, max.—excellent regulation, low hum. Also supplies fixed, regulated bias voltage,—150 volts, 5 ma, and two unregulated, 6.3 volt, ac output at 5 amperes each. See page 142

RELAY-RACK ADAPTOR PANELS FOR UNIT INSTRUMENTS

Relay-rack adaptor panels provide still further flexibility of application for General Radio Unit Instruments. Panels are available for mounting each unit with power supply, except for the TYPE 1218-A Unit Oscillator which, because of its size, must be mounted separately.

TYPE 1217-A with TYPE 1203-B in relay-rack panel.



Panel Type	Height—inches	Fits Types—	Code Word	Price
480-P4U1	7	1201, 1203, 1214	UNIPANARCH	\$10.00
480-P4U2	7	1204, 1206, 1210, 1212, 1213, 1216, 1217, 1219, or 1220	UNIPANBOLT	10.00
480-P4U3	7	1204, 1206, 1210, 1212, 1213, 1217, or 1220 } and { 1201, 1203, or 1214	UNIPANCART	10.85
480-P5UC1	8¾	1211 or 1215 and 1201 or 1203	UNIPANGOLF	15.00
480-P4UC1	7	1208 and 1201 or 1203	UNIPANDOCK	12.00
480-P4UC2	7	1209 and 1201 or 1203	UNIPANFORT	12.00
480-P7U1	12¼	1218	UNIPANHUMP	15.00



VARIAC[®] AUTOTRANSFORMERS



General Radio's VARIAC[®] autotransformer gives smooth, continuous, manual control of ac voltage from zero to 17% above input line voltage. Available in single units and in combinations in ratings from 300 va to 25 kva, Variacs are designed for maximum efficiency, continuous service, long life, and minimum maintenance.

USES: A few of the countless applications of the Variac in the shop and in the laboratory are:

- Control of a-c voltage in testing and development work.
- Control of electric heaters and ovens in the laboratory, pilot plant, and production line.
- Overvoltage and undervoltage tests.
- Output voltage control in transformer-rectifier power supplies.
- Voltage control on racks for aging of lamps, vacuum tubes, and dry-disk rechargers.
- Lighting control in theaters, auditoriums, photographic studios, and darkrooms.
- Motor speed control.
- Voltage control in the calibration of voltmeters and ammeters.
- Phase-angle control in the calibration of wattmeters and power-factor meters.
- Variacs, although built for 115- and 230-volt circuits, can be used on circuits of higher or lower voltage in conjunction with fixed-ratio auxiliary transformers. Ganged units are available for parallel, series, and polyphase connections (see page 205).

DESCRIPTION: The Variac consists of a single-layer winding on a toroidal iron core. As the

dial is rotated a carbon brush contact traverses the winding, "tapping off" a portion of the total voltage across the winding. The brush is always in contact with the winding, and the voltage between turns is always less than 1 volt, even in the largest models, while in the smallest model it is only about 0.3 volt.

The voltage increments obtained as the dial is turned are always less than the voltage between turns; since the brush spans more than one turn, the change in voltage is practically continuous. The brush characteristics are such that excessive heating does not occur in the turns bridged by the brush.

DURATRAK: Variacs have brush tracks treated by the *Duratrak*^{*} process, which coats the brush-track surface with a uniform silver alloy, to prevent oxidation and brush-track deterioration. *Duratrak* makes the Variac as durable as a fixed-ratio autotransformer. *Duratrak* means long life; high overload capacity, and minimum maintenance requirements. With *Duratrak*, a Variac can stand a momentary overload of 1000 percent without damage.

FEATURES:

- High efficiency.
- Smooth control.
- Good voltage regulation.
- Negligible waveform distortion.
- Voltage varies linearly with dial rotation.
- Output voltage above line voltage.
- Adaptability to motor drive.

*Developed in the General Radio Laboratories.
PATENT NOTICE. See Note 8, page x.

Cutaway view of
W-model Variac





VARIAC TYPE NUMBERS

TYPE numbers for Variac® Autotransformers and their various combinations are made up of letters and numerals that indicate exactly what elements are included in each assembly. An example is shown at the right.

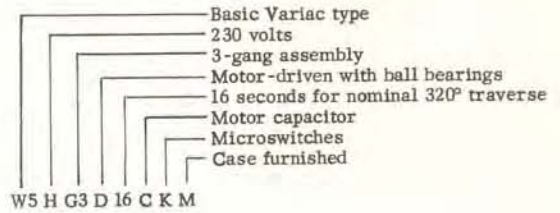

GENERAL SPECIFICATIONS

Dial: Dial plates are reversible; 0 to 115 volts on one side, 0-135 on the other. H-models have similar scales 0-230 and 0-270.

Protective Devices: MT and MTS models have built-in circuit breakers; TYPES W50, W50H, W20H, and W5L have built-in fuse-type protectors (see curves below).

Overload Ratings: Rated current may be safely exceeded for short-time overloads as indicated in the curves below. The shaded area shows the limits for those Variacs that have built-in fuse-type protectors (TYPES W5L, W20H, W50, W50H). For all other models, use the curve for Variac alone.

Frequency: Specifications of W-models are for 50- to 60-cycle service. Variacs can be operated at rated current and voltage at line frequencies from 50 to 400 cycles. For 25-cycle service, refer to page 213. For 400- to 1200-cycle service, refer to page 214.

Rated Current can be drawn from the Variac at any dial position. When the overvoltage connection is used, the load should not take more than rated current at maximum output voltage setting.

Maximum Current can be drawn at maximum voltage when the line-voltage connection is used. At any lower setting the Variac will control a constant-impedance load drawing no more than the maximum current at line voltage.

Output Voltage is the range of voltage available at the output terminals with rated input voltage.

Terminals: TYPE W2, W5, W10, and W20 have combined soldering and screw-type terminals. TYPE W50 models have self-locking terminals.

Line-Voltage or Overvoltage Output Connections: "Line Voltage Connection" refers to the connection for output voltage range of zero to line voltage. "Overvoltage connections" refers to the connection for output voltage range of zero to 17% above line voltage.

KVA Rating is the maximum current multiplied by normal input line voltage. A Variac can handle, at any lower setting, a constant-impedance load that draws at rated input voltage a current no greater than the maximum current.

Temperature Rise: Variac ratings are based on operation at ordinary room temperatures, with an average temperature rise of not more than 50°C. When ambient temperature exceeds 50°C, kva ratings should be decreased as shown in the chart on this page.

No-load Loss is measured at 60 cycles with rated input voltage. Losses are guaranteed not to exceed the values given in specifications.

Driving Torque is the torque required to turn the Variac shaft.

Panel Thickness is the maximum thickness of the panel on which the Variac can be mounted, with the shaft normally supplied.

Mounting: See photographs on following pages.

Dimensions: Over-all dimensions are given with the individual Variac descriptions. Complete dimensional sketches and drilling templates will be furnished on request.

Weight: See individual specifications.

For ambient temperatures above 50 deg. C, the VARIAC should be derated according to this curve.

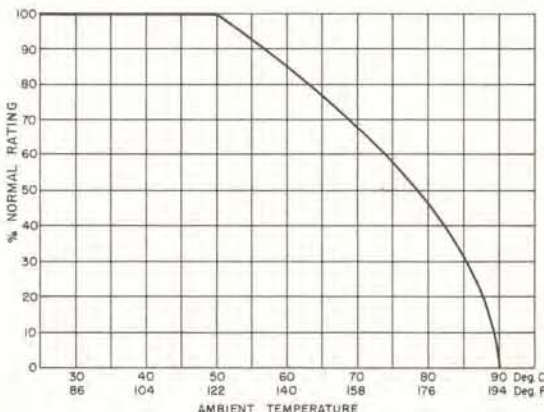

For use when high initial surge current may be expected (motor starting, incandescent lamp load, etc.) and for short-time overloads, the VARIAC rated current may be exceeded on a time-current basis as shown in this figure.

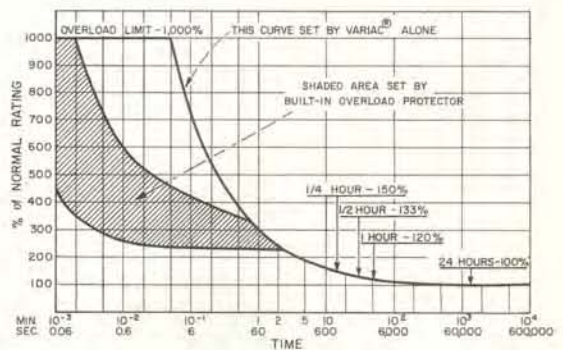



GANGED VARIAC® ASSEMBLIES

FOR PARALLEL, SERIES, AND THREE-PHASE OPERATION

The usefulness of the Variac is extended through two- and three-gang Variac assemblies, to the control of several circuits from a single knob, to the control of

Variacs connected in parallel or in series, or to the control of three-phase circuits, either wye or delta connected.

PARALLEL COMBINATIONS

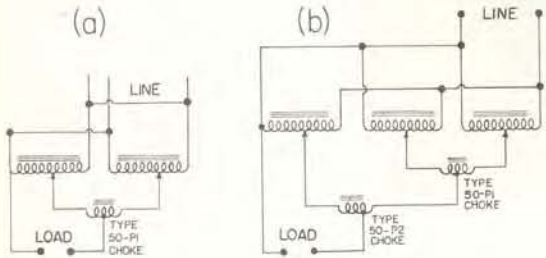

The larger-size VARIACS (TYPES W20 and W50) can be operated in parallel if a TYPE 50-P1 Choke is used to limit circulating current, as shown in circuit (a) at left. Load rating of two identical VARIACS in parallel is twice that of a single VARIAC. Parallel operation is not usually recommended for smaller VARIACS, because the use of the next larger size VARIAC is more economical. Where a load rating in excess of two TYPE W50 units is needed, a third unit can be added by using a TYPE 50-P2 Choke, as shown in circuit (b). Four-gang and six-gang units can also be paralleled. For the 4-gang parallel connection, three TYPE 50-P1 Chokes are needed; for the 6-gang, three TYPE 50-P1 and two TYPE 50-P2. See page 211 for prices of chokes.

THREE-PHASE COMBINATIONS

Open-Delta Connection: With this connection, two Variacs will control a three-phase load from a three-phase source. Maximum output voltage can be either line voltage or 17 percent above line voltage. The load rating of a two-gang open-delta circuit is 1.732 times that of a single Variac. With 230-volt models, output voltages of more than double the supply voltage can be obtained, although current and power ratings are halved.

Wye Connection: Wye-connected Variacs can be operated from three-phase lines of twice the Variac leg voltage rating. This is because the voltage across each leg of a wye-connected assembly equals line volts divided by $\sqrt{3}$, and because 115-volt Variacs are wound for a maximum of 135 volts and 230-volt Variacs are wound for a maximum of 270 volts. With the wye connection, the voltage across the Variac on a 460-volt line is 266 volts,

and on a 230-volt line, 133 volts. Although the over-voltage feature is sacrificed in this circuit, the kva rating is increased by the ratio 133:115. Load rating of a wye-connected assembly is 3.47 times that of a single unit.

As with single-phase assemblies, Variacs can also be paralleled on three-phase circuits. A 4-gang delta connection requires two TYPE 50-P1; a 6-gang, two TYPE 50-P1 and two TYPE 50-P2. A 6-gang wye requires three TYPE 50-P1.

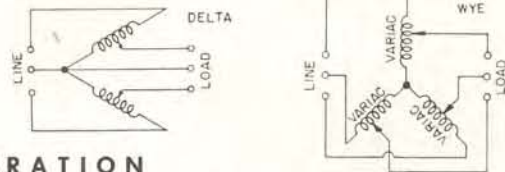

SERIES OPERATION

The series connection is useful in the operation of 115-volt units from 230-volt lines and 230-volt units from 460-volt lines. This circuit cannot be used, however, when a common connection between line and load is required, as, for instance, when the load is grounded.

Ganged Variacs are supplied completely assembled and ready for wiring and installation.

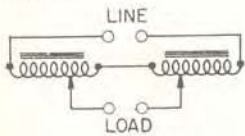

A three-gang, cased TYPE W5 Variac (TYPE W5G3M).



TYPE 50-P1 Choke for limiting circulating current in parallel combinations.

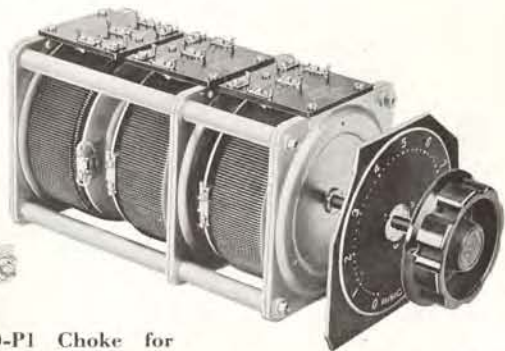

A three-gang TYPE W20 Variac (TYPE W20G3).





THE W-MODEL VARIAC



Portable model with convenient handle has overload protector and is available in 2- and 3-wire models.



Cased model for wall mounting has conduit knockouts.



Uncased model for panel mounting.

The W-model Variac is the latest result of a continuous development program that started over 20 years ago, when General Radio introduced the first commercial variable auto-transformer. The advent of the W-model is a major stride in this development. Design features include Underwriters Laboratory listing for the W2, W5, W20, and W50, military ruggedization, and counterbalanced rotating parts. The basic open units have square mounting bases for convenient installation. Cased models are totally enclosed for protection from dust, with ready access to the interior. Wall-mounted, cased models have conduit knockouts, for ganged assemblies as well as for individual units.

A portable model, which can be used in either a horizontal or a vertical position, has a built-in circuit breaker and is supplied with a carrying handle. This model is available with the new standardized three-wire grounded cord set and receptacle, as well as with the more usual two-wire arrangement.

W-model Variacs are interchangeable with comparable-size, older, V-models*, since mounting holes corresponding to those of V-models are provided on the W-model base.

The flexibility of the new design permits the manufacture of units incorporating many special modifications, such as the addition of ball bearings, motor drive, continuous 360-degree rotation, and two separate brush tracks. All W-models are *Duratrak* treated.

M-model Variacs for 400- to 1200- cycle service are similar in design to W-models (page 214).

*Some V-models are still available for those who find it inconvenient to change to the new W-models.

VARIAC INDEX

115-VOLT INPUT		
KVA	Type	Page
0.36	W2	207
0.9	W5	208
1.5	W10	209
3	W20	210
5.75	W50	211
6	W20G2	210
9	W20G3	210
11.50	W50G2	211
17.25	W50G3	211
230-VOLT INPUT		
SINGLE PHASE		
0.6	W5H	208
0.7	W2G2	207
1.2	W10H	209
1.8	W5G2	208
2.4	W20H	210
3	W10G2	209
4.8	W20HG2	210
6	W20G2	210
7.5	W50H	211
15	W50HG2	211
22.5	W50HG3	211
460-VOLT INPUT		
1.2	W5HG2	208
2.4	W10HG2	209
4.8	W20HG2	210
15	W50HG2	211
230-VOLT INPUT		
THREE PHASE		
1.0	W5HG2	208
1.25	W2G3	207
2.1	W10HG2	209
3.1	W5G3	208
4.1	W20HG2	210
5.2	W10G3	209
10.4	W20G3	210
13	W50HG2	211
20	W50HG3	211
460-VOLT INPUT		
2.1	W5HG3	208
4.1	W10HG3	209
8.2	W20HG3	210
26	W50HG3	211
Motor Drives		212
Specials		213
High-Frequency		
Units		214
25-cycle Ratings		213
Metered Models		215



Cover of cased model is easily removable for access to terminals, mounting holes, and brush.

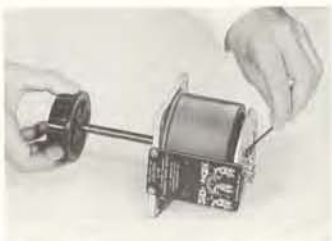

Shaft can be easily adjusted or replaced without disturbance to the rest of the assembly.



Overload protector, a new feature on portable models, is reset from front panel.





TYPE W2 VARIAC WITH DURATRAK

Type W2M

Cased Model, with Conduit Knockouts.

Case Dimensions: Width $4\frac{1}{8}$ in., Height: $5\frac{5}{16}$ in., Depth: $4\frac{1}{4}$ in.



Type W2MT, W2MT3

Portable Model.

For 2-Wire Service (Type W2MT3 for 3-Wire).

With Overload Protector, Carrying Handle, Cord, Plug, and Outlet.

Case Dimensions: same as for W2M.



Type W2

Uncased Model.

Mounting Base: $3\frac{1}{4}$ inches square.

Depth Behind Panel: $3\frac{1}{16}$ inches.

Four Mounting Holes on $2\frac{3}{4}$ -inch square, also 3 holes on $1\frac{1}{4}$ -inch radius.

Max. Panel: $\frac{3}{8}$ inch.

Complete dimension drawings furnished on request.

Type	Mounting	Input Voltage	Line-Voltage Connection			Overvoltage Connection			Driving torque ounce-inches	Net Weight—pounds	Code Word	Price
			Rated Output Current—amp.	Output Voltage	Maximum Current—amp.	Output kva	Output Voltage	Rated Output Current—amp.				
W2	Uncased	115	2.4	0-115	3.1	0.36	0-135	2.4	3.5	5-10	$3\frac{5}{8}$ BAGAL	\$13.50
W2M	With case	115	2	0-115	2.6	0.30	0-135	2	3.5	5-10	$4\frac{1}{8}$ BAGER	19.00
W2MT	Portable 2-wire	115	See Note ¹ Below				0-135	2	3.5	5-10	$4\frac{3}{4}$ BAGIC	24.00
W2MT3	Portable 3-wire	115	See Note ¹ Below				0-135	2	3.5	5-10	$4\frac{3}{4}$ BAGOM	26.00
VB-1	Replacement Brush											0.75

¹ MT models are shipped with overvoltage connections and corresponding dial scales, but can be supplied on special order with line-voltage connections and dial scales.

GANGED ASSEMBLIES

Dials for ganged assemblies are marked 0 to 10 on one side, 10 to 0 on the other. For ratings of gangs, see page 205. A set of right-angle mounting brackets is supplied. To determine ratings of gang for various classes of service, refer to page 205. For ball bearings and motor drive, refer to page 212.



TYPE W2G3M



TYPE W2G3

Type	Description	Net Weight pounds	Code Word	Price
W2G2	2-gang	$7\frac{1}{4}$	BAGALGANDU	\$32.00
W2G2M	2-gang cased	$8\frac{3}{4}$	BAGALBONDU	40.00
W2G3	3-gang	$10\frac{3}{4}$	BAGALGANTY	48.00
W2G3M	3-gang cased	$12\frac{1}{4}$	BAGALBONTY	56.00

Complete dimension drawings furnished on request.





TYPE W5 VARIAC WITH DURATRAK



Types W5, W5H
 Uncased Model.
 Mounting Base: 4½ inches square.
 Depth Behind Panel: 4 inches.
 4 Mounting Holes on 3¾ inch square;
 also 3 holes on 1¾-inch radius.
 Max. Panel: ¾ inch.

Types W5M, W5HM
 Cased Model, with Conduit Knockouts.
 Case Dimensions:
 Width 4⅞ in., Height 6⅞ in., Depth 4¼ in.



Types W5MT, W5HMT, W5MT3
 Portable Model.
 For 2-Wire Service (TYPE W5MT3 for 3-wire).
 With Overload Protector, Handle, Cord, Plug and Outlet.
 Case dimensions same as W5M.

Complete dimension drawings furnished on request.

Type	Mounting	Input Voltage	Line-Voltage Connection				Overvoltage Connection		60-cycle no-load loss—watts	Driving torque ounce-inches	Net Weight pounds	Code Word	Price
			Rated Output Current—amp.	Output Voltage	Maximum Current—amp.	Output Icc	Output Voltage	Rated Output Current—amp.					
W5	Uncased	115	6	0-115	7.8	0.9	0-135	6	9	10-20	6¾	COTAL	\$17.00
W5M	With case	115	5	0-115	6.5	0.75	0-135	5	9	10-20	7½	COTER	22.50
W5L	Uncased	115	8.5	0-115	11.	1.27	2	2	12	10-20	6½	COTUG	17.50
W5LM	With case	115	7.1	0-115	9.2	1.1	2	2	12	10-20	7¼	COTAT	23.00
W5MT	Portable 2-wire	115	See Note ¹ Below				0-135	5	9	10-20	8¼	COTIC	27.50
W5MT3	Portable 3-wire	115	See Note ¹ Below				0-135	5	9	10-20	8¼	COTOM	30.00
W5H	Uncased	230 115	2 1	0-230	2.6	.6	0-270 0-270	2 1	9	10-20	6½	JOBAL	20.50
W5HM	Cased	230 115	2 1	0-230	2.6	.6	0-270 0-270	2 1	9	10-20	7¼	JOBER	26.00
W5HMT	Portable 2-wire	230	See Note ¹ Below				0-270	2	9	10-20	8	JOBIC	31.00
VB-2	Replacement brush for W5, W5L											0.75	
VB-1	Replacement brush for W5H											0.75	

¹MT models are shipped with overvoltage connections and corresponding dial scales, but can be supplied on special order with line-voltage connections and dial scales.

²For 60-cycle use only; no overvoltage connection provided.

For 25-cycle operation, see page 213.

GANGED ASSEMBLIES

Type		Net Weight pounds	Code Word	Price	Type		Net Weight pounds	Code Word	Price
W5G2	2-gang	13¾	COTALGANDU	\$41.00	W5LG3*	3-gang	19½	COTUGGANTY	\$62.50
W5G2M	2-gang cased	14¼	COTALBONDU	49.00	W5LG3M*	3-gang cased	21½	COTUGBONTY	70.50
W5G3	3-gang	20½	COTALGANTY	61.00	W5HG2	2-gang	13¼	JOBALGANDU	48.00
W5G3M	3-gang cased	22¼	COTALBONTY	69.00	W5HG2M	2-gang cased	14½	JOBALBONDU	56.00
W5LG2*	2-gang	13¼	COTUGGANDU	42.00	W5HG3	3-gang	20¼	JOBALGANTY	71.50
W5LG2M*	2-gang cased	13¾	COTUGBONDU	50.00	W5HG3M	3-gang cased	22¼	JOBALBONTY	79.50

UL-CSA APPROVAL: TYPES W5, W5L, W5M, W5MT, and W5MT3 are listed under the Re-examination Service of the Underwriters' Laboratories. TYPES W5, W5M, W5H, W5HM, W5MT, W5HMT, and W5MT3 are approved by the Canadian Standards Association.

*Cannot be used in 230-volt, 3-phase, wye connection or single-phase overvoltage connection; can be used in wye connection on 208-volt, 3-phase line.





TYPE W10 VARIAC WITH DURATRAK

Type W10M, W10HM

Cased Model, with conduit knockouts.

Case Dimensions: (width) $6\frac{3}{4}$ × (height) $9\frac{1}{2}$ × (depth) $5\frac{1}{4}$ inches.

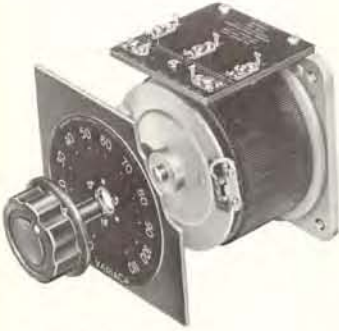

Type W10, W10H

Uncased Model.

Base: $5\frac{3}{4}$ inches square.

Depth behind panel: $4\frac{1}{16}$ inches.

Mounting holes on $4\frac{3}{4}$ -inch square; also 3 holes on $2\frac{3}{8}$ -inch radius.

Max. Panel: $\frac{1}{2}$ inch.



Type W10MT3, W10HMT3

Portable Model, for 3-wire service.

Has overload protector, carrying handle, cord, plug, and outlet. Case dimensions, same as for TYPE W10M.

Completed dimension drawings furnished on request.

Type	Mounting	Input Voltage	Line-Voltage Connection				Overvoltage Connection		60-cycle no-load loss—watts	Driving torque ounce-inches	Net Weight—pounds	Code Word	Price
			Rated Output Current—amp.	Output Voltage	Maximum Current—amp.	Output kva	Output Voltage	Rated Output Current—amp.					
W10	Open	115	10	0-115	13	1.5	0-135	10	17	15-30	12½	DOGAL	\$31.00
W10M	With case	115	10	0-115	13	1.5	0-135	10	17	15-30	15	DOGER	44.00
W10MT	Portable 2-wire	115	See Note ¹ Below				0-135	10	17	15-30	16	DOGIC	48.00
W10MT3	Portable 3-wire	115	See Note ¹ Below				0-135	10	17	15-30	16	DOGOM	51.00
W10H	Open	230 115	4 2	0-230	5.2	1.2	0-270 0-270	4 2	17	15-30	12	LUTAL	33.00
W10HM	With case	230 115	4 2	0-230	5.2	1.2	0-270 0-270	4 2	17	15-30	14½	LUTER	46.00
W10HMT	Portable 2-wire	230	See Note ¹ Below				0-270	4	17	15-30	15½	LUTIC	50.00
W10HMT3	Portable 3-wire	230	See Note ¹ Below				0-270	4	17	15-30	15½	LUTOM	53.00
VBT-10	Replacement Brush for TYPE W10											1.25	
VBT-11	Replacement Brush for TYPE W10H											1.25	

¹ MT and MT3 models have overvoltage connection and corresponding dial scales, but can be supplied on special order with line voltage connections and dial scales.

For 25-cycle operation, refer to page 213.

GANGED ASSEMBLIES

Dials for ganged assemblies are marked 0 to 10 on one side, 10 to 0 on the other. For ratings of gangs, see page 205. A set of right-angle mounting brackets is supplied. To determine

ratings of gang for various classes of service, refer to page 205. For ball bearings and motor drive, refer to page 212.



TYPE W10G2

Type	Description	Net Weight pounds	Code Word	Price
W10G2	2-gang	26½	DOGALGANDU	\$ 72.00
W10G2M	2-gang cased	30½	DOGALBONDU	93.00
W10G3	3-gang	39½	DOGALGANTY	105.00
W10G3M	3-gang cased	43½	DOGALBONTY	128.00
W10HG2	2-gang	25	LUTALGANDU	76.00
W10HG2M	2-gang cased	29	LUTALBONDU	97.00
W10HG3	3-gang	37	LUTALGANTY	111.00
W10HG3M	3-gang cased	42½	LUTALBONTY	134.00





TYPE W20 VARIAC WITH DURATRAK



Type W20M, W20HM
Cased Model, with conduit knock-outs.

Case Dimensions: (width) $8\frac{5}{8}$ × (height) $11\frac{1}{8}$ × (depth) $5\frac{3}{8}$ inches.

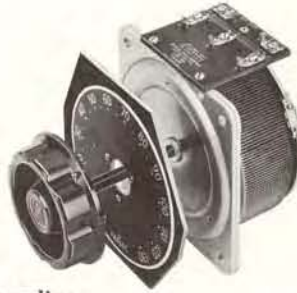

Type W20*, W20H*

Uncased Model.

Base: $7\frac{1}{2}$ inches square.

Depth behind panel: $4\frac{5}{8}$ inches.

4 Mounting holes on

$6\frac{1}{4}$ -inch square; also 3 holes on 3-inch radius.

Max. Panel: $\frac{3}{8}$ inch.

*Approved under re-examination service of the Underwriters' Laboratories.



Type W20MT3, W20HMT3
Portable Model, for 3-wire service.

Has overload protector, carrying handle, cord, plug, and outlet. Case dimensions, same as for TYPE W20M.

Type	Mounting	Input Volts	Line-Voltage Connection				Overvoltage Connection		60-cycle no-load core loss—watts	Driving torque ounce-inches	Net Weight Pounds	Code Word	Price
			Rated Output Amps.	Output Voltage	Max. Output Amps.	Output KVA	Output Volts	Rated Output Amps.					
W20	Uncased	115	20	0-115	26	3.0	0-135	20	27	45-90	21½	FEDAL	\$45.00
W20M	With case	115	20	0-115	26	3.0	0-135	20	27	45-90	24½	FEDER	58.00
W20MT3	Portable	115	See Note ¹ Below				0-135	20	27	45-90	28	FEDOM	87.00
W20H	Uncased	230	8	0-230	10.4	2.4	0-270	8	27	45-90	20½	MEPAL	47.00
		115	4				0-270	4					
W20HM	With case	230	8	0-230	10.4	2.4	0-270	8	27	45-90	23½	MEPER	60.00
		115	4				0-270	4					
W20HMT3	Portable	230	See Note ¹ Below				0-270	8	27	45-90	27	MEPOM	85.00
VBT-8	Replacement brushes for W20 models, per set											2.50	
VBT-12	Replacement brushes for W20H models, per set											2.50	

¹ MT3 models have overvoltage connections and corresponding dials, but can be supplied on special order with line-voltage connection and scales.

For 25-cycle operation, see page 213.

GANGED ASSEMBLIES

Dials for ganged assemblies are marked 0 to 10 on one side, 10 to 0 on the other. For ratings of gangs, see page 205. A set of right-angle mounting brackets is supplied. To determine

ratings of gang for various classes of service, refer to page 205. For ball bearings and motor drive, refer to page 212.

GANGED ASSEMBLIES

Type	Description	Net Weight pounds	Code Word	Price
W20G2	2-gang	44	FEDALGANDU	\$100.00
W20G2M	2-gang cased	48	FEDALBONDU	125.00
W20G3	3-gang	65	FEDALGANTY	147.00
W20G3M	3-gang cased	71	FEDALBONTY	175.00
W20HG2	2-gang	41	MEPALGANDU	104.00
W20HG2M	2-gang cased	45	MEPALBONDU	129.00
W20HG3	3-gang	61	MEPALGANTY	153.00
W20HG3M	3-gang cased	67	MEPALBONTY	181.00

TYPE W20G3M





TYPE W50 VARIAC WITH DURATRAK



TYPE W50, W50H



TYPE W50G3M



TYPE W50M, W50HM

Dimensions: Uncased models, base 12½ inches square; depth behind panel, 6¼ inches; four mounting holes on 10¾-inch square; also 3 holes on 4½-inch radius. Cased models with conduit knockouts; case, (height) 16½ × (width) 13¾ × (depth) 7½ inches. Complete dimension drawings on request.

UL and CSA APPROVED
TYPE W50 and W50H Variacs are listed under the re-examination service of the Underwriters' Laboratories, and are also approved by the Canadian Standards Association.

Type	Mounting	Input (50-60 cycles) Volts	Line-Voltage Connection				Overvoltage Connection			60-cycle no-load Loss—Watts	Driving Torque—ounce-inches	Net Weight—Pounds	Code Word	Price
			Rated Output Amperes	Output Volts	Max. Output Amperes	Output KV A	Output Volts	Rated Output Amperes						
W50	Uncased	115	50	0-115	50	5.75	0-135	50	50	150-300	50	GATAL	\$120.00	
W50M	Cased	115	40	0-115	45	5.18	0-135	40	50	150-300	57	GATER	145.00	
W50H	Uncased	230 115	25	0-230	32.5	7.5	0-270 0-270	25 12.5	50	150-300	53	NITAL	120.00	
W50HM	Cased	230 115	20	0-230	31	7.13	0-270 0-270	20 10	50	150-300	60	NITER	145.00	
VBT-6	Replacement brushes for W50, per set												5.50	
VBT-7	Replacement brushes for W50H, per set												5.50	

For 25-cycle operation, see page 213.

GANGED ASSEMBLIES

For series, parallel, or three phase connections, ganged W50 units can deliver up to 26 kva. See page 205 for calculation of ratings. Be sure to order chokes for the

parallel connection. Dials on ganged units read 0-10. Dimension drawings on request.

Type		Weight	Code Word	Price	Type	Weight	Code Word	Price	
W50G2	2-Gang	103lbs	GATALGANDU	\$260.00	W50G5BBM	5-Gang	295	GATALBONFO	\$735.00
W50G2M	2-Gang	115½	GATALBONDU	310.00	W50G6BB	6-Gang	325	GATALGANSA	800.00
W50G3	3-Gang	158	GATALGANTY	385.00	W50G6BBM	6-Gang	355	GATALBONSA	870.00
W50G3M	3-Gang	173½	GATALBONTY	440.00	W50HG4BB	4-Gang	230	NITALGANKA	540.00
W50HG2	2-Gang	109	NITALGANDU	260.00	W50HG4BBM	4-Gang	255	NITALBONKA	600.00
W50HG2M	2-Gang	121½	NITALBONDU	310.00	W50HG5BB	5-Gang	295	NITALGANFO	670.00
W50HG3	3-Gang	167	NITALGANTY	385.00	W50HG5BBM	5-Gang	320	NITALBONFO	735.00
W50HG3M	3-Gang	182½	NITALBONTY	440.00	W50HG6BB	6-Gang	355	NITALGANSA	800.00
W50G4BB	4-Gang	215	GATALGANKA	540.00	W50HG6BBM	6-Gang	385	NITALBONSA	870.00
W50G4BBM	4-Gang	240	GATALBONKA	600.00	50-P1	Choke	1¼	PARALLCHOK	16.00
W50G5BB	5-Gang	270	GATALGANFO	670.00	50-P2	Choke	1¼	TRIPLECHOK	16.00





BALL BEARINGS

W- and M-models can readily be supplied with ball bearings, which provide more precise alignment, and slightly lower and more nearly constant torque.

When ordering a Variac or gang equipped with ball bearings, add the suffix -BB to the type number and add the price shown in the accompanying table. For cutaway view of ball-bearing model, see page 203.

Ball bearings are standard equipment on all motor-driven Variacs and on all 4-, 5-, and 6-

gang W50 and W50H models and are included in the price.

SURCHARGE FOR BALL BEARINGS

Type	W2	W5, W5H, W5L, M5	W10, W10H, M10	W20, W20H, M20	W50, W50H
Single Unit	5.00	6.00	7.00	8.00	15.00
Two-Gang	7.00	8.00	9.00	10.00	20.00
Three-Gang	9.00	10.00	11.00	12.00	25.00

SPECIAL VARIACS

Special Variacs can be supplied to meet specific requirements, such as additional winding taps, fungicide treatment, special shaft lengths, or output voltages or voltage ranges different from those of standard models.

The General Radio Company welcomes in-

quiries on special Variacs, and is glad to furnish them when the quantities involved are sufficient to make production economically practicable.

Variacs can also be supplied on special order less knob, dial, etc., at lower net prices.

MOTOR-DRIVEN VARIACS

All Variac Autotransformers, both single units and gangs, can be furnished with motor drive. The motor mounting plate is attached to the Variac base by four posts, and the motor is geared to the Variac shaft. *All motor-driven models are equipped with ball bearings.*

Fully enclosed, two-phase, gear-reduction motors of the servo type, having very low moment of inertia, are used. Three basic speeds are available, which together with a selection of stocked, standard, coupling gears make possible the assembly of units having full traverse rates of 2, 4, 8, 16, 32, 64, and 128 seconds. The 2- and 4-second models are intended for high-speed servo applications, while the slower models are primarily intended for remote positioning applications, although they are used for slower-speed servo work. Motors are 115-volt, 50-to-60-cycle types.

The two-phase motor supply may be derived

from either (1) a servo amplifier or (2) from the 115-volt line, with a capacitor to produce the necessary phase shift. Capacitor is supplied.

Mechanical stops are adequate for the higher speeds, but electrical limit switches are necessary for the slower types. Limit switches can also be provided for the higher speeds, however, and are sometimes used for signaling purposes or to stop rotation at any desired point.

Cases similar to those on W gangs are available for motor-driven models, whether single units or gangs.

In the table on page 213, available combinations are listed for each size of Variac. When less than 5 units are ordered, the set-up charge must be included. All prices shown are to be added to the price of the Variac (single unit or gang) on which the drive is to be installed.

2-gang W5 motor-driven Variac, with case.



2-gang W2 motor-driven Variac.





Seconds for 320° Traverse ⁵	Microswitches Required ³	2	4	8	16	32	64	128	Unit ¹ Price in lots of 5 or more (add to price of Variac or gang)	Set-up Charge Prorated 1 to 4 units	Add for case
		No	No	No	No	Yes	Yes	Yes			
VARIAC TYPE W or M ⁴ 115 or 230 volts	2	X	X	X	X	X	X		\$ 80.00	\$6.00	\$12.00
	2G2	X	X	X	X	X	X		82.00	6.00	12.00
	2G3	X	X	X	X	X	X		84.00	6.00	12.00
	5	X	X	X	X	X	X		81.00	6.00	16.00
	5G2	X	X	X	X	X	X		83.00	6.00	16.00
	5G3	X	X	X	X	X	X		85.00	6.00	16.00
	10	X	X	X	X	X	X		97.00 ⁶	12.00	32.00
	10G2		X	X	X	X	X		99.00 ⁶	12.00	34.00
	10G3			X	X	X	X		101.00 ⁶	12.00	36.00
	20	X	X	X	X	X	X	X	103.00 ⁶	12.00	35.00
	20G2	X	X	X	X	X	X	X	105.00 ⁶	12.00	38.00
	20G3	X	X	X	X	X	X	X	107.00 ⁶	12.00	41.00
	50	X	X	X	X	X	X	X	133.00	12.00	55.00
	50G2		X	X	X	X	X	X	123.00	12.00	60.00
	50G3			X	X	X	X	X	128.00	12.00	65.00
	50G4	Note ²		X	X	X	X	X			
50G5				X	X	X	X				
50G6				X	X	X	X				

¹ For less than 5 units, prorate set-up charge over quantity ordered.² Models below heavy line are available on special order and are all supplied with microswitches. Prices on request.³ Add \$7.00 per unit for microswitches.⁴ 60-cycle motor on 400-cycle Variac.⁵ Nominal for 60-cycle supply. Actual speeds may vary ±20% from this value.⁶ Add \$8.00 per unit for M type Variacs.

VARIACS FOR 25-CYCLE SERVICE

230-volt Variacs, designed for 60-cycle service, can be used on 25-cycle supply at one-

half their 60-cycle voltage and load ratings, as listed in the table below.

Type	Rated Input-Volts	Line-Voltage Connection				Overvoltage Connection	
		Rated Output Current-Amperes	Output Voltage Range	Max. Output Current-Amperes	KVA at Max. Output Voltage	Output Voltage Range	Rated Output Current-Amperes
W5H, HM, HMT*	115	2	0-115	2.6	.3	0-135	2
W10H, HM, HMT*, HMT3*	115	4	0-115	5.2	.6	0-135	4
W20H, HM, HMT*, HMT3*	115	8	0-115	10.4	1.2	0-135	25
W50H	115	25	0-115	32.5	3.75	0-135	25
W50HM	115	20	0-115	31	3.5	0-135	20

For prices, code words, and other specifications see pages 208-211.

When ordering, please specify that VARIAC is for 25-cycle service, in order that proper dial may be furnished.

*HMT and HMT3 models are normally supplied for overvoltage connection and dial but can be supplied with line-voltage connection and dial on special order.





TYPE M VARIACS FOR 350- TO 1200-CYCLE SERVICE



Type M2
Dimensions identical with TYPE W2, except depth behind panel is 2½ inches.



Type M5
Dimensions identical with TYPE W5, except depth behind panel is 2¾ inches.



Type M10
Dimensions identical with TYPE W10, except depth behind panel is 3⅙ inches.

TYPE M Variacs are the high-frequency equivalents of the TYPES W2, W5, W10 and W20. Similar in design to the 60-cycle W-models, they are much smaller and lighter. TYPE M Variacs are especially useful with the 400-cycle power supplies that are used in airborne and marine equipment. They can be supplied with ball bearings and 60-cycle motor drives (page 212).

FEATURES:

- TYPE M Variacs are mechanically rugged, built to withstand a vibration test of 10 to 55 cycles, 1/32-inch amplitude, and a 1200-ft-lb shock test of MIL-T-945A.
- The coil bears solidly, through a thin insulator, against a cast aluminum base, which in turn has an annular mounting surface. Good thermal conductivity is thus achieved between

coil and base and between base and panel.

- Wiring diagram on terminal board.
- Usable from 350 to 1200 cycles per second.
- Duratrak contact surface provides extra factor of reliability under overload. Instantaneous peaks of ten times rated current can be handled.
- Brush track shows no significant wear after one million cycles of brush operation (0 to maximum and return).
- Two-ampere model (TYPE M2) has 400 turns, giving adequate resolution for many computing and control operations.
- Variac meets military corrosion, salt-spray, and fungus-resistance requirements.
- Four corner mounting holes provided for ganging and mounting, in addition to the three standard mounting holes used on earlier models.

Type	M2	M5	M10	M20†
Line Frequency	350-1200 cps	350-1200 cps	350-1200 cps	350-1200 cps
Input Voltage	115 v	115 v	115 v	115 v
Output Voltage	0-135 or 0-115 v	0-135 or 0-115 v	0-135 or 0-115 v	0-135 or 0-115 v
Rated Current	2.4 amp.	6 amp.	10 amp.	20 amp.
Maximum Current*	3.1 amp.	7.8 amp.	13 amp.	26 amp.
No-Load Loss at 400 c	3 w	6 w	14 w	27 w
No. of Turns on Winding	402	293	209	169
D-C Resistance of Winding	6.6Ω (approx)	1.3Ω (approx)	0.36Ω (approx)	0.15Ω (approx)
Driving Torque	5-10 oz-in.	10-20 oz-in.	15-30 oz-in.	45-90 oz-in.
Angle of Rotation	320 degrees	320 degrees	320 degrees	320 degrees
Replacement Brushes	VB-1: 75¢	VB-2: 75¢	VBT-10: \$1.25	VBT-8: \$2.50
Weight, pounds	1⅞	3¼	6⅝	13
Code Word	BAGGY	CANNY	CABIN	CAVIL
Price	\$14.50	\$18.50	\$30.00	\$48.00

*For line voltage connection only. For ganged models, refer to the following page.

† Dimensions identical with TYPE W20 except depth behind panel is 3⅙ inches.





GANGED TYPE M VARIACS FOR HIGH-FREQUENCY SERVICE



TYPE M10G2

TYPE M Variacs are available as two-gang assemblies for 115-volt, three-phase, open-delta connection (or for controlling two circuits from a single shaft), and as three-gang assemblies for 208- or 230-volt, three-phase, wye-

connection (or for controlling three circuits from a single shaft).

A TYPE 50-P1 Choke is recommended if a two-gang unit is to be operated in parallel; for three-gang units, a TYPE 50-P2 Choke is required in addition to the TYPE 50-P1.

Type	Description	Net Wt.		Code Word	Price
		Lbs.			
M-2G2	2-Gang M-2	3 ⁵ / ₈		BAGGYGANDU	\$33.00
M-2G3	3-Gang M-2	5 ¹ / ₂		BAGGYGANTY	49.50
M-5G2	2-Gang M-5	6 ³ / ₄		CANNYGANDU	41.00
M-5G3	3-Gang M-5	10 ¹ / ₄		CANNYGANTY	61.50
M-10G2	2-Gang M-10	12 ¹ / ₈		CABINGANDU	65.00
M-10G3	3-Gang M-10	19		CABINGANTY	97.00
M-20G2	2-Gang M-20	26 ¹ / ₂		CAVILGANDU	107.00
M-20G3	3-Gang M-20	38 ¹ / ₈		CAVILGANTY	155.00

METERED VARIACS

TYPE W5MT3A



TYPE W5MT3W



With the Metered Variacs, voltage, current, and power measurements can be made without the use of external meters. The TYPE W5MT3A Metered Variac reads load volts and amperes; the TYPE W5MT3W reads load volts and watts.

Each assembly consists of a TYPE W5 Variac, the meters, a current transformer, and the necessary switching and meter shielding. The shielding is sufficiently effective to reduce

the Variac stray field to a point permitting an over-all accuracy of 3% (full scale) with 2% meters. Three-wire power cords are used for both line and load. The ON-OFF switch disconnects both sides of the line. A make-before-break range switch permits switching under load the dual-scale ammeter (in TYPE W5MT3A) or the wattmeter (in TYPE W5MT3W). Load circuit is fused.

SPECIFICATIONS

Frequency: 50-60 cycles.
 Input Voltage: 115
 No Load Loss (60 cycles): 9 watts.
 Output Voltage: 0-135 (0-150 voltmeter)
 Output Current: (W5MT3A) Two ranges 0-1, 0-5 amperes.
 Output Watts: (W5MT3W) Two ranges—0-150, 0-750 watts.
 Meter Accuracies: ±3% of full scale.
 Switching: OFF-ON, two-pole switch disconnects assembly from line in "OFF" position.
 Meter RANGE, HIGH-LOW, make-before-break to permit switching under load.

Terminals: Line—3-wire cord and plug.
 Load—3-wire outlet receptacle (will accept parallel 2-wire plug).
 Fusing: W5MT3A—1 ampere, low range. 5 ampere, high range.
 W5MT3W—2 ampere, low range. 5 ampere, high range.
 Angle of Rotation: 325°
 Driving Torque: 30-60 oz-in.
 Case Dimensions: 9¹/₁₆ high, 6³/₄ wide, 6³/₈ deep and handle.
 Net Weight: 11³/₄ pounds.

Type	Description	Code Word	Price
W5MT3A	Metered Variac (voltmeter, ammeter)	CABAL	\$ 85.00
W5MT3W	Metered Variac (voltmeter, wattmeter)	CABOB	110.00



HANDLES ANY LOAD UP TO 6 KVA

TYPE 1570-A AUTOMATIC VOLTAGE REGULATOR

USES: The TYPE 1570-A Automatic Voltage Regulator is used in both laboratory and industrial applications where constant a-c line voltage is required. *It combines high accuracy for laboratory use with large capacity for industrial applications.* Typical applications for this instrument are: Laboratory power, computers, critical transmitter supply voltages, meter test benches, carefully controlled industrial processes and installation in military equipment.

DESCRIPTION: The TYPE 1570-A Automatic Voltage Regulator consists of a Variac® adjustable auto-transformer, an auxiliary step-down transformer which multiplies the power rating of the Variac, and a servomechanism, which controls automatically the setting of the Variac to hold the output voltage constant.

The rectified output voltage is filtered, and the d-c component compared to a stable voltage reference tube to obtain a d-c error voltage. This error voltage is amplified by a two-stage balanced amplifier with lead and

lag networks for shaping the phase and amplitude response for optimum performance.

The thyatron-controlled servo-motor is a true proportional control device rather than an off-on device and provides a smooth control with no "dead zone." The Variac driven by this servo-motor is equipped with ball-bearings to reduce friction to a minimum.

In addition to the standard models listed below, a militarized model and a three-phase model are also available. These are described on page 218.

FEATURES:

- Zero waveform distortion.
- High accuracy.
- Independent of load.
- No power-factor restrictions.
- Tolerates short-duration overloads.
- Adjustable output voltage.
- High efficiency.
- High response speed.
- High power capacity.

The oscillograms below show traces of 60 cycle voltage sine-wave peaks illustrating the response speed of the TYPE 1570 Line Voltage Regulator. (a) Left, 2% change (step function) in voltage input to regulator; (b) center, voltage output of regulator as a result of 2% input voltage change shown in (a); (c) right, voltage output of regulator as the input voltage is changed 1%.





SPECIFICATIONS

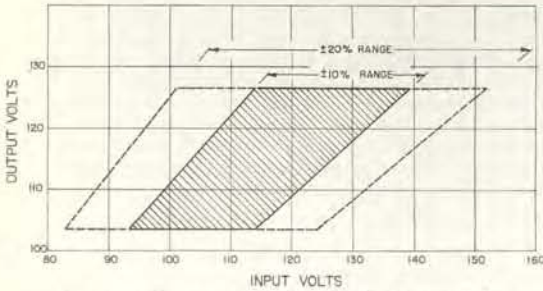

Range of operation for 115-volt models; for 230-volt models, multiply voltage scales by 2.

Input Voltage Range: The desired output voltage will be maintained if the input voltage does not vary by more than $\pm 10\%$ from this value of output voltage. A $\pm 20\%$ range connection is also available.

Output Voltage: Adjustable over a range of $\pm 10\%$ from a base value of 115 volts (for TYPE 1570-AL) or 230 volts (for TYPE 1570-AH) by means of a screw-driver adjustment on panel.

Output Voltage	115 Nominal Adjustable $\pm 10\%$		230 Nominal Adjustable $\pm 10\%$	
	90% to 110%	80% to 120%	90% to 110%	80% to 120%
Input voltage as a percentage of output voltage*				
Output current amperes	50	25	20	10
KVA	6	3	5	2.5
Accuracy in % of output voltage	0.25%	0.5%	0.25%	0.5%
Speed of Response volts per second†	10	20	20	40

* TYPES 1570-AL and 1570-AH can be connected for either $\pm 10\%$ or $\pm 20\%$ input voltage range. Instruments are shipped connected for $\pm 10\%$ range unless 20% range is specified on order.
† Slightly less for very small voltage corrections.

Tube Complement: 2-12AX7's, 1-5651, 2-5727's.

Terminals: Two 15-ampere power cords, supplied with the instrument may be used to connect the regulator when it is used as a portable instrument. Terminals are easily accessible when other connections are desired.

Waveform Distortion: None.

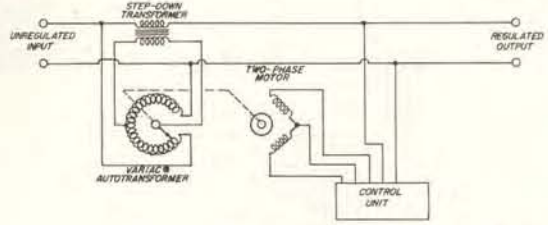

Elementary schematic diagram of the TYPE 1570 Line Voltage Regulator.

Accessories Supplied: Rack and table models—2 power cords, spare fuses; wall models—cabinet, cover, and mounting screws.

Waveform Error: The average value of the output voltage is held constant, and a loaded d-c power supply operated from the output of the regulator will give constant output voltage regardless of the harmonic distortion present in the power line. The rms output voltage will also remain constant, regardless of the harmonic distortion present, as long as the phase and amplitude of these harmonics are constant. If the harmonic content changes, the rms value will change by an amount less than $\Delta R/n$, where ΔR is the change in the harmonic amplitude and n is the harmonic number.

Ambient Temperature: Full ratings apply up to 40°C.

Frequency: 60-cycle models will operate from 55 to 65 cycles; 50-cycle models, from 45 to 55 cycles.

Power Consumption: No Load 35 watts
Full Load 100 watts

Mountings: Relay Rack (- R model), Table top (- M model) and Wall (- W model).

Dimensions:	Rack and Table Top Models	Wall Models
	Width	19 in.
Height	7 in.	19½ in.
Depth (over-all)	12¾ in.	8¼ in.
Depth (behind panel)	11¼ in.	
Weight	56½ lb.	63½ lb.

View of wall-mounted regulator. This model is used to regulate line voltages in the General Radio development and testing laboratories.



Type	Description	Code Word	Price
1570-ALM	Table Top Model, 115 volts, 60 cycles	CEDAR	\$490.00
1570-ALR	Relay Rack Model, 115 volts, 60 cycles	CHARY	490.00
1570-ALW	Wall Model, 115 volts, 60 cycles	CLOWN	490.00
1570-AHM	Table Top Model, 230 volts, 60 cycles	CHALK	510.00
1570-AHR	Relay Rack Model, 230 volts, 60 cycles	CURLY	510.00
1570-AHW	Wall Model, 230 volts, 60 cycles	CLOSE	510.00
1570-ALQ6*	115 volts, 50 cycles	PASHA †	515.00
1570-AHQ11*	230 volts, 50 cycles	REGAL †	535.00

* Insert M, R, or W, for table, relay-rack, or wall model, respectively.

† Suffix; add to code word for corresponding 60-cycle model, i.e., CEDARPASHA for TYPE 1570-ALMQ6.

PATENT NOTICE. See Note 8, page x.





MILITARIZED VOLTAGE REGULATOR—TYPE 1570-AS15



The TYPE 1570-AS15 Automatic Voltage Regulator, a militarized version of the standard TYPE 1570-A, meets the requirements of MIL-E-4158B and MIL-E-16400. For ease of maintenance the Control Unit, containing the servo amplifier, has been separated from the Regulator Unit, which consists of the motor driven Variac and buck-boost transformer.

The Regulator Unit is mounted on a U-beam extruded panel, which provides the ruggedness necessary to pass the standard 1200 ft-lb shock test and the vibration test of .030 inches excursion from 10-55 cps. For environmental protection the transformers are hermetically sealed and all aluminum parts are Infridite-coated. The motor shaft is stainless steel, and the motor windings are completely encapsulated in an epoxy resin. Suitable military lubricants are used throughout.

The Control Unit has been particularly designed for

reliability and ease of maintenance. The highest quality components are used, hermetically sealed where possible. Most components are operated at less than half their voltage or power ratings. All vacuum tubes are the more reliable military types and are operated at less than 20% of their maximum plate current ratings. All tubes can be replaced directly without removal of any dust covers. The removal of a single top cover exposes all components and removal of the bottom plate exposes all wiring as well as a complete circuit diagram and parts list.

SPECIFICATIONS

Tube Complement: Two 5751, one 5651WA, two 5727/2D21W, one 6626/6A2WA.

Input Voltage Range: $\pm 9\%$ for full ratings, $\pm 18\%$ for half rating.

Terminals: Jones connector strip.

Frequency: 45-55 cycles or 55-65 cycles, as selected by a switch.

Other specifications are identical with those for TYPE 1570-AH and -AL, page 217.

Accessories Supplied: Control Unit power cord, spare fuses.

Dimensions: Control Unit, panel, 19 x 3½ inches; depth behind panel, 7 inches. Regulator Unit, panel 19 x 7 inches; depth behind panel, 9⅝ inches.

Net Weight: 64 pounds.

Type		Code Word	Price
1570-ALS15	Automatic Voltage Regulator, 115 volts.....	CLOTH	\$670.00
1570-AHS15	Automatic Voltage Regulator, 230 volts.....	CLOUD	690.00

MILITARIZED 3-PHASE REGULATOR—TYPE 1570-AS25

The TYPE 1570-AS25 is a militarized three-phase regulator similar to the single phase TYPE 1570-AS15. A three-gang motor-driven Variac is used to control the three phases simultaneously in response to variations in one phase. Where system is unbalanced, three TYPE 1570-AS15 regulators should be used, one on each phase.

SPECIFICATIONS

Ratings

	1570-ALS25		1570-AHS25	
* Output Voltage per phase	115 \pm 10%		230 \pm 10%	
** Input Voltage as a percent of Output Voltage	91% to 109%	82% to 118%	91% to 109%	82% to 118%
Output Current per phase	.25	12.5	10	5
Approx. KVA (wye ***)	8.6	4.3	6.9	3.5
† Accuracy in % of output voltage	.25	.5	.25	.5
†† Speed of response, volts per second	5	10	10	20

*** Delta rating is $\frac{1}{\sqrt{3}}$ times wye rating.

* Internal adjustment.

** Instruments are shipped connected for $\pm 9\%$ range unless $\pm 18\%$ range is specified on order.

† Slightly less for very small voltage corrections.

† Applies only to measured phase. Other phases depend on input voltage and load balance.



Terminals: Jones connector strip.

Accessories Supplied: Control Unit power cord, spare fuses.

Power Consumption: No load, 35 watts. Full load, 140 watts.

Dimensions: Control Unit, panel, 19 x 3½ inches; depth behind panel, 7 inches; Regulator Unit, panel, 19 x 7 inches; depth behind panel, 16¾ inches.

Net Weight: 97 pounds.

Other specifications are identical with those for TYPE 1570-AS15.

Type		Code Word	Price
1570-ALS25	3-phase Regulator, 115 volts.....	DICKY	\$865.00
1570-AHS25	3-phase Regulator, 230 volts.....	DAILY	885.00

For the control of 400-cycle power a special militarized control unit is available. This control unit requires approximately 35 watts of power at 45-65 cps. When used with the Regulator Unit for the Type 1570-AS15, it will control up to 6 KVA of power at 400 cycles to 0.25%. It can also be used with the Regulator Unit for the Type 1570-AS25. Write for prices.



VARIAC® SPEED CONTROLS



FOR OPERATING DC MOTORS FROM AC LINES

VARIAC Speed Controls are compact, high-performance motor speed controls, designed to operate dc shunt, compound, or series motors from an ac line. The motors are operated with constant field excitation and adjustable armature voltage, obtained from a Variac autotransformer and rectifier, so that shunt motor regulation characteristics are obtained.

No electronic tubes are used in these controls. Rectifiers are of the metallic or semiconductor type, so there is no time delay in starting.

Variac® Motor Speed Controls are available in four power ratings: $\frac{1}{15}$, $\frac{1}{6}$, $\frac{1}{3}$, and $\frac{3}{4}$ horsepower. They are simple and rugged, have good regulation, and are particularly suited to shop installation. They have given excellent performance in a wide variety of laboratory, machine-tool, and industrial applications.

For each size motor speed control, a basic model is available for assembly into other equipment. These are identified by the suffix W in their type numbers. These models include the basic components of the mounted controls, but switching and overload protection must be supplied by the user.

Shown below is the basic circuit for the motor speed controls. Two sets of full-wave rectifiers are used. One set supplies fixed field voltage; the other a continuously adjustable

armature voltage, controlled by a Variac autotransformer.

The choke in the armature circuit, in conjunction with the full-wave selenium rectifier, assures continuous conduction throughout the a-c cycle, providing a low-impedance source of essentially ripple-free armature current.

Armature overload protection is accomplished with slo-blow fuses in the $\frac{1}{15}$ th and $\frac{1}{6}$ hp-models, and with magnetic circuit breakers, in the $\frac{1}{3}$ and $\frac{3}{4}$ hp-models.

FEATURES:

- Smooth Wide-Range Speed Control—15:1 for most applications; up to 100:1 or more with light or smooth loads.
- Versatile Starting Characteristics: Smooth, controlled starting for delicate loads; fast high-torque starting for heavy loads.
- Dynamic braking in all models $\frac{1}{6}$ hp and higher brings the armature to a quick stop.
- Instant Starting.
- Quick Reversing.
- Negligible AC Ripple—Motor need not be derated—No torque pulsation.
- Low First Cost.
- Very low maintenance. No electronic tubes.
- Simple installation.

PATENT NOTICE. See Note 8, page x.

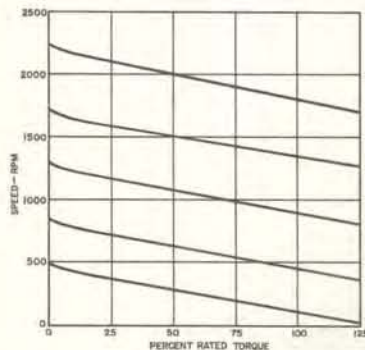

(Left) Speed-Torque characteristics of a typical motor and speed control installation. (Below) Circuit diagram of a Variac Motor Speed Control.

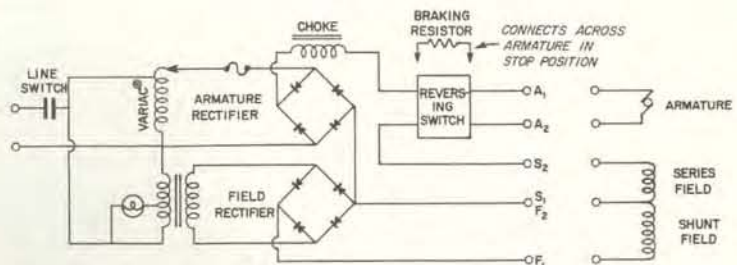



1/6, 1/3, and 3/4 Horsepower

COMPLETE MODELS IN CABINET WITH SWITCHES

TYPE 1703-A, TYPE 1700-B, AND TYPE 1702-A



TYPE 1703-A



TYPE 1700-B



TYPE 1702-A

These fractional horsepower models are completely assembled with switching and control elements on the face of the cabinet.

Typical applications include feed and spindle drives, winding machines, grinders, drill presses, conveyors, and processing machinery.



TYPE 1700-CW

BASIC (W) MODELS—ON CHASSIS WITH COVER

TYPES 1703-BW, 1700-CW, AND 1702-BW

Basic models of the 1/6 to 3/4 hp controls, these models have the essential elements, including the braking resistor, mounted on a simplified chassis with cover. The VARIAC is supplied separately to be mounted by the customer. A suitable switch or drum controller can be supplied (see page 221).

Type	Model	D.C. Field	Speed	Code Word	Unit Price			Recommended Motor
					1-4	5-19	20-up	
1703-A (1/6 hp)	Complete in Cabinet	115 v.	0-rated	WEBBY	\$105.00	\$102.00	\$99.00	MOD-11
66 v.		0-1 1/4 x rated						
48 v.		0-1 1/2 x rated						
1700-B (1/3 hp)	Cabinet	115 v.	0-rated	AFOOT	180.00	176.00	172.00	MOD-3
75 v.		0-1.15 x rated						
1702-A (3/4 hp)		115 v.	0-rated					
75 v.	0-1.15 x rated							
1703-BW (1/6 hp)	Basic (Chassis with cover, and Variac)	115 v.	0-rated	SABOT	90.00	87.50	85.00	MOD-11
66 v.		0-1 1/4 x rated						
48 v.		0-1 1/2 x rated						
1700-CW (1/3 hp)		115 v.	0-rated	SALTY	155.00	151.50	148.00	MOD-3
75 v.		0-1.15 x rated						
1702-BW (3/4 hp)		115 v.	0-rated					
75 v.	0-1.15 x rated							

Input Line: 105-125v., 50-60c., 275 watts, for 1/6 hp. 105-125v., 60 c., 560 and 1150 watts for 1/3, and 3/4 hp respectively (50 c available on special order).

Armature Output: 0-115 v., dc at 1.5, 3.0 and 6.5 amps for 1/3, 1/6 and 3/4 hp respectively.

Overload Protection: Fuses in 1/6 hp and magnetic circuit breakers for 1/3 and 3/4 hp complete controls only.

Motors: MOD-11, 1/6 hp Compound, 1725 rpm, 25 lbs, Code Word MOTOR*, Price \$58.00.

MOD-3, 1/3 hp Compound, 1725 rpm, 30 lbs, Code Word MOTOR*, Price \$65.00.

MOD-25, 3/4 hp, Compound with interpoles, 1725 rpm, 60 lbs, Code Word MOTOR*, Price \$106.00

Dimensions and Weight: 1703: Cabinet Model 7 1/8 x 7 3/4 x 4 3/8, 9 lbs; Basic Model, Chassis 7 1/2 x 10 3/4 x 3 1/2, 4 1/2 lbs, Variac 3 1/4 x 3 1/16 x 4 3/8, 3 1/2 lbs.

1700: Cabinet Model 12 7/8 x 9 3/8 x 6, 23 1/2 lbs; Basic Model, Chassis 9 3/4 x 12 5/8 x 5, 17 lbs, Variac 4 1/2 x 4 15/16 x 5 1/2, 6 1/2 lbs.

1702: Cabinet Model 13 1/2 x 15 1/2 x 6 1/2, 41 lbs; Basic Model, Chassis 11 1/4 x 15 1/4 x 5 7/8, 27 1/2 lbs, Variac 5 3/4 x 6 1/4 x 5 7/8, 11 1/4 lbs.

* When ordering control with motor, use compound code word; for example, WEBBYMOTOR is the code word for TYPE 1703-A with motor. Motors are not sold separately.





UP TO 1/15 Horsepower

FULLY ENCLOSED MODELS—COMPLETE IN CABINET
TYPES 1701-AK AND 1701-AM



TYPE 1701-AK

For shunt motors, 1/15 hp and below.

Typical applications are: Feed drives for lathes, milling machines, grinders and punch presses; rewinding and take-up drives; jewelers' lathes and other very light machinery; photographic and other processing equipment. — AK model has two speed ranges; — AM model has one, and armature fuse is accessible from front panel.

TYPE 1701-AU

Like TYPE 1701-AK, but for series and universal motors. One speed range. Gives shunt regulation characteristics with inexpensive universal motor at speeds up to 10,000 rpm. Motor

field and armature leads must be separate.

Applications similar to TYPE 1701-AK, but including also higher speed applications, such as small, very high-speed drill presses.

BASIC (W) MODEL—OPEN CHASSIS—TYPE 1701-AKW

Basic model of the 1/15-hp control. It contains the essential elements such as the choke, rectifiers and transformers mounted on a chassis, and the Variac supplied as a separate unit to be mounted by the customer. No switches or overload protection are supplied. They may be chosen by the customer to suit his applications.



TYPE 1701-AKW

Type	Model	D.C. Field	Speed	Code Word	Unit Price	Recommended Motor
1701-AK	Complete in Cabinet	115 v.	0-rated	WINDY	1-4 \$85.00	MOD-21
		38 v.	0-2 x rated		5-19 83.00	
1701-AM		115 v.	0-rated	WIDOW	20 up 81.00	MOD-21
1701-AU		10 v.	0-rated	WEARY	1-4 90.00	MOD-4
		16 v.			5-19 88.00	
				20 up 86.00		
1701-AKW	Basic (Chassis and Variac)	115 v.	0-rated	SERUM	1-4 72.00	MOD-21
		38 v.	0-2 x rated		5-19 68.50	
					20 up 65.50	

Input Line: 105-125 v., 60 c. or 105-120 v., 50 c., 175 watts.

Armature Output: 0-115 v. dc, 0.8 a.

Motors: MOD-21 Shunt, 1/15 hp, 1725 rpm, 8 lbs, Code Word MOTOR*, Price \$38.00.

MOD-4 Universal, 1/15 hp, 8800 rpm, 3 3/4 lbs, Code Word MOTOR*, Price \$21.50.

Dimensions Cabinet Models: 5 7/8 x 6 7/8 x 4 5/8 inches, over-all; 6 pounds.

and Weight: Basic Models: Chassis 6 1/8 x 9 x 2 3/4 inches, 2 1/4 pounds; Variac 3 1/4 x 3 1/16 x 4 3/8 inches, 3 1/2 pounds.

* When ordering control with motor, use compound code word: for example, WINDYMOTOR is the code word for TYPE 1701-AK with motor. Motors are not sold separately.

SWITCH AND CONTROLLER

For Use With 1/3-HP and 3/4-HP Basic Models

The appliance-type switch supplied with the TYPE 1700-B and TYPE 1702-A controls is available as a separate item, the TYPE 1702-P3 Switch, to use with the W-Models. This switch has enough contacts to break the a-c and d-c circuits simultaneously, and also to handle reversing and dynamic braking. A drum switch, which is particularly suited for machine-shop production work, is also available as a separate item for use with the W-models.



TYPE 1705-P1 Controller



TYPE 1702-P3 Switch

Type	Code Word	Price
1702-P3	Switch.....	FLIPO \$ 6.00
1705-P1	Drum Controller..	DRUMO 22.00





WAVEFORM-MEASURING INSTRUMENTS

The choice of an instrument for evaluating the components of a complex electrical signal, an acoustic noise, or a mechanical vibration depends upon the character of the signal, the information that is needed, and how the results are to be used. For example, if the wave is a periodic one that is stable in frequency, each individual component is readily measured with the TYPE 736-A Wave Analyzer. The very high selectivity of this analyzer with its 4-cycle bandwidth is independent of the frequency to which the analyzer is tuned, because the analyzer is a heterodyne type. This selectivity characteristic, obtained by quartz-crystal filters, is invaluable in the measurement of intermodulation distortion of amplifiers and other audio equipment. As an electronic voltmeter in the measurement of the transmission characteristics of electrical wave filters and as a null detector for impedance bridges, the excellent selectivity is of particular value in avoiding the effects of interfering signals, hum, noise, and distortion products.

The TYPE 1554-A Sound and Vibration Analyzer, described in the section on Sound and Vibration finds its greatest use in the measurement of the components of noise, either electrical or acoustical, when the selectivity of the TYPE 736-A Wave Analyzer is often too great for rapid analysis, and in the measurement of noises whose frequency components fluctuate. It provides two bandwidths, one a constant percentage (8%) of the frequency to which its dial is set, the other a third octave.

Although its tuning is continuous, if one assumes that the analyzer separates its range from 2.5 to 25,000 cps into contiguous bands, according to its effective band-

width, it will have about 100 bands without appreciable overlap, as contrasted with about 3200 bands for the full range of the wave analyzer.

The TYPE 760-A Sound Analyzer is a similar instrument for a smaller frequency range, as is the TYPE 762-B Vibration Analyzer for lower frequencies but both have narrower bandwidths than the TYPE 1554 (about 2% as contrasted with 8%), and neither has the third-octave feature.

When a still simpler division of the spectrum is desired, the TYPE 1550-A Octave-Band Noise Analyzer (described in the section on Sound and Vibration) is available for division of the spectrum from 20 to 10,000 cps into eight bands.

The TYPE 1932-A Distortion and Noise Meter is a more specialized, yet remarkably versatile analyzer, designed for the routine and rapid measurements on audio systems. This electronic voltmeter uses the complete signal as a reference value. A selective network suppresses the fundamental component, and the remainder, which includes distortion components, hum and noise, is then measured. This single-number distortion rating is a convenient and frequently used figure of merit of the performance of an audio system.

Used with a cathode-ray oscillograph, it becomes a versatile production testing tool, immediately indicating optimum conditions, whenever adjustments are made that affect distortion or noise. Noise, distortion and hum are readily distinguished, and a distinction between second-harmonic and third-harmonic distortion can also be made.

Type	Name	Class	Frequency Range-cps	Tuning Method	Bandwidth (3 db)	Input Voltage Range	Measurement Application	Power Supply	See Page
736-A	Wave Analyzer	Heterodyne 50-kc crystal filter	20-16,000	Continuous (1 range)	4 cps	10 microvolts to 300 volts	Separating steady components	A-C Line	223
1554-A	Sound and Vibration Analyzer	RC Degen-erative	2.5-25,000 (4 ranges)	Continu-ous	8% and third octave	100 μ v to 3 v	Separating Components and Broad-Band Noise	Batteries	192
760-B	Sound Analyzer	R-C De-generative	25-7500	Continuous (5 ranges)	2% of in-dicated frequency	1 milli-volt to 10 volts	Separating components	Batteries	193
762-B	Vibration Analyzer	R-C De-generative	2.5-750	Continuous (5 ranges)	2% and 10% of in-dicated frequency	1 milli-volt to 10 volts	Separating components	Batteries	193
1550-A	Octave-Band Noise Analyzer	L-C Filter	20-10,000	Band Switch (8 bands)	2:1	66 db	Broad-Band Noise	Battery	190
1932-A	Distortion and Noise Meter	R-C Rejec-tion	50-15,000 (funda-mental)	Continuous (5 ranges)	Rejection band at 60 db = 0.02%	80 db	Harmonic Distortion—Relative Hum and Noise	A-C Line	225



TYPE 736-A WAVE ANALYZER



USES: The wave analyzer is used to measure the amplitude and frequency of the components of a steady-state complex electrical waveform. These include not only the components of harmonic distortion, but also those of intermodulation distortion, noise, and hum.

Specific uses of the TYPE 736-A Wave Analyzer include the measurement of distortion components in audio-frequency equipment, broadcast receivers and transmitters, telephone systems, public address equipment, oscillators, amplifiers, and vacuum-tube circuits in general; harmonic studies on electric power systems and electrical machinery; hum measurement in a-c operated communication equipment; noise analysis; and induction studies on telephone lines. As a sharply tuned voltmeter, it is invaluable in the measurement of the transmission characteristics of electric wave filters and as a null detector for impedance bridges. It is an excellent detector for intermodulation distortion measurements.

DESCRIPTION: The TYPE 736-A Wave Analyzer is a heterodyne type of vacuum-tube voltmeter. The intermediate-frequency ampli-

fier includes a highly selective filter using three quartz crystals. The use of a heterodyne method makes it possible to vary the response frequency while using a fixed-frequency filter.

The output of the local oscillator and the whole of the complex waveform to be examined are fed to a balanced modulator where their combination produces both the sum and difference frequencies, or side bands, in the output. The original of the complex waveform is not passed by the modulator intermediate-frequency output transformer, and the local-oscillator carrier frequency is suppressed in the output because of the two-tube balanced modulator employed.

The 50-kilocycle component of the upper side band, proportional to the voltage of that frequency present in the original wave to which the main dial is set, is selected and amplified by the intermediate stages. The step attenuators provided make it possible to measure a wide range of voltages.

FEATURES:

➤ A "flat top" characteristic as shown by the curve (next page) is obtained by using

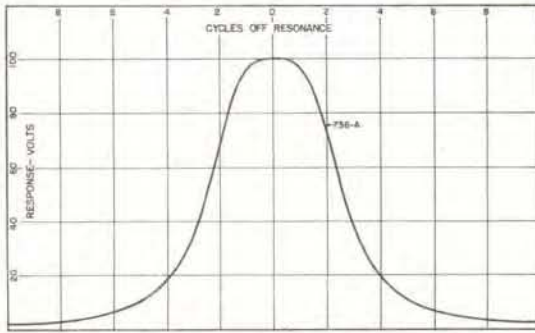

Transmission characteristic of the crystal filter in the TYPE 736-A Wave Analyzer.

the three-crystal filter. This feature makes tuning easier and increases the stability of the tuning adjustment.

- A very wide range of input voltages—1,000,000 to 1, full scale—can be accommodated directly.
- Self-contained calibrating systems make it possible to standardize the voltage and frequency calibrations easily at any time.
- The input impedance is constant at 1 megohm, but a built-in 100,000-ohm potentiometer is provided as an alternate input system where absolute voltage levels need not be determined.
- External magnetic fields cause no trouble because the balanced modulator is fed by a phase inverter tube, rather than by a transformer.
- Humidity effects are minimized by the hermetic sealing of all critical parts.

SPECIFICATIONS

Frequency Range: 20 to 16,000 cycles.

Selectivity: Approximately as shown in plot, above. The response is down 15 db at 5 cycles, 30 db at 10 cycles, 60 db at 30 cycles from the peak. The selectivity is constant over the frequency range.

Voltage Range: 500 microvolts to 300 volts full scale. The lowest division on the meter corresponds to 10 μ v. The over-all range is divided into four major ranges: 300 μ v to 300 mv, 3 mv to 3 v, 30 mv to 30 v, 0.3 to 300 v. Each of these ranges is divided into seven scale ranges; for example, the 0.3 v to 300 v range has the following full-scale ranges: 0.3 v, 1 v, 3 v, 10 v, 30 v, 100 v, 300 v.

A direct-reading decibel scale is also provided.

Voltage Accuracy: Within $\pm 5\%$ on all ranges. Spurious voltages from higher order modulation products introduced by the detector are suppressed by at least 70 db. Hum is suppressed by at least 75 db.

Input Impedance: One megohm when used for direct voltage measurements. When used with the input potentiometer it is approximately 100,000 ohms.

Accuracy of Frequency Calibration: $\pm (2\% + 1 \text{ cycle})$.

Tube Complement:

- 6—6J7
- 2—6K6-G
- 1—6B8
- 1—6C5
- 1—6X5-G
- 1—6F5-G
- 3—NE-48 neon lamps

Power Supply: 105 to 125 volts (or 210 to 250), 40 to 60 cycles. A voltage stabilizing circuit is included. Power input is about 65 watts. Power input receptacle will accept either 2-wire (TYPE CAP-35) or 3-wire (TYPE CAP-15) power cord. Two-wire cord is supplied. For 3-wire, see page 237.

Accessories Supplied: Spare neon lamps, spare fuses, one TYPE 274-NL Shielded Connector, and a TYPE CAP-35 Power Cord.

Mounting: Shielded oak cabinet.

Dimensions: (Width) $19\frac{1}{2}$ \times (height) $25\frac{1}{8}$ \times (depth) $10\frac{7}{8}$ inches, over-all.

Net Weight: $86\frac{1}{4}$ pounds.

Type	Code Word	Price
736-A Wave Analyzer	ASKEW	\$1200.00

For other audio-frequency analyzers, see pages 192 and 193.

Schematic diagram of TYPE 736-A Wave Analyzer.

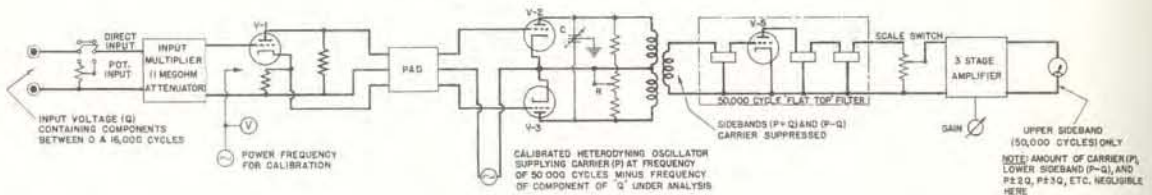



TYPE 1932-A DISTORTION AND NOISE METER



USES: The TYPE 1932-A Distortion and Noise Meter measures distortion, noise, and hum level in audio-frequency circuits. In conjunction with the TYPE 1931-B Modulation Monitor, or the TYPE 1184-A TV Monitor, it can be used to measure these quantities directly in the output of radio broadcasting transmitters. It finds many uses in the electronics laboratory and in the production testing of radio receivers as a wide-range, highly sensitive voltmeter for such measurements, as signal-to-noise ratio, AVC characteristics, and hum level. With the aid of an oscilloscope, individual hum and distortion components can be identified.

DESCRIPTION: The principal elements of the unit are a high-gain amplifier with an R-C interstage coupling unit that balances to a sharp null, a calibrated attenuator for adjusting the sensitivity, and a vacuum-tube voltmeter. Degeneration maintains stability in amplifier gain and a flat transmission characteristic, except within an octave of the null frequency. The null frequency is continuously

variable. The null network eliminates the fundamental of the audio-frequency signal, leaving only the distortion products, which are indicated directly on the panel meter.

The null network is switched out of the circuit for noise and hum measurements, and the instrument then operates as a highly sensitive voltmeter. Two input circuits are provided: (1) a transformer for bridging a 600-ohm line; and (2) a direct connection to the 100,000-ohm gain control.

FEATURES:

- Continuous adjustment of frequency over the entire audio range is provided.
- Quick frequency selection.
- Frequencies up to 45,000 cycles are passed by the amplifier circuits, so that distortion measurements can be made on fundamental frequencies up to 15,000 cycles.
- Distortion as low as 0.1% can be measured.
- An auxiliary dbm calibration is provided.
- An oscilloscope connection is provided for visual observation of the noise or distortion components.

Functional schematic of the TYPE 1932-A Distortion and Noise Meter.

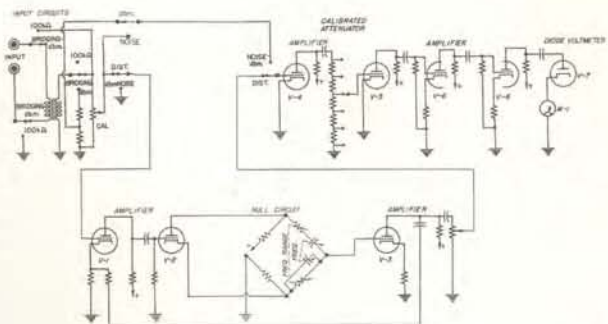



SPECIFICATIONS

Distortion Range: Full-scale deflections for 0.3%, 1%, 3%, 10% or 30% distortion.

Noise Measurement Range: 80 db below reference calibration level, or 80 db below an audio-frequency signal of zero dbm level, at maximum sensitivity.

Audio-Frequency Range: 50 to 15,000 cycles (fundamental), for distortion measurements; 30 to 45,000 cycles for noise and hum measurements.

Dbm Range: Power-level range is from +20 to -60 dbm. (0 dbm is one milliwatt in 600 ohms).

Input Voltage Range: 1.2 to 30 volts for the 100-kilohm input, and 0.8 to 30 volts for the 600-ohm bridging input.

Accuracy: For distortion measurements, $\pm 5\%$ of full scale for each range \pm residual distortion as noted below; for noise and dbm measurements, $\pm 5\%$ of full scale.

Residual Distortion Level:

100-Kilohm Input: 0.05%, max., below 7500 c;
0.10%, max., above 7500 c.

Bridging Input: 0.10%, max., between 50 and 70 c;
0.05%, max., between 70 and 7500 c;
0.10%, max., above 7500 c.

Residual Noise Level: Less than -80 db.

Input Impedance: 100,000 ohms unbalanced, and 600-ohm bridging input (10,000 ohms), balanced or unbalanced.

Meter: A large meter with an illuminated scale is provided, calibrated in percentage and db. The ballistic characteristic is similar to that of a vu meter.

Tube Complement:

4-6J5-GT 1-6K6-GT 1-6X5GT
1-6SN7-GT 1-6H6 2-0D3

Accessories Supplied: TYPE CAP-35 Power Cord, cable

for connecting to the TYPE 1931-B Modulation Monitor, spare fuses.

Other Accessories Required: For measuring the distortion in oscillators and other audio-frequency sources no additional equipment is required. For measurements on amplifiers, lines, and other communications networks, a low-distortion oscillator is required. TYPE 1301-A Low-Distortion Oscillator (see page 101) is recommended. When the modulated output of a radio transmitter is to be measured, a linear demodulator is necessary. The TYPE 1931-B Modulation Monitor (page 140) and the TYPE 1184-A TV Monitor (page 136) are recommended. However, any detector system having minimum undistorted output of 1.5 volts rms can be used. **Terminals:** Terminals are provided at the rear for connection to the modulation monitor. A Western Electric jack is provided at the panel also, as an auxiliary input circuit. Plugging into this jack automatically disconnects the rear connectors.

Power Supply: 105 to 125 (or 210 to 250) volts, 50 to 60 cycles. The line input power is 65 watts.

Power input receptacle will accept either 2-wire (TYPE CAP-35) or 3-wire (TYPE CAP-15) power cord. Two-wire cord is supplied. For 3-wire, see page 237.

Mounting: The instrument is relay rack mounted. End frames are available for table mounting. (See price list below.)

Panel Finishes: Standard General Radio crackle. Certain standard finishes which can be processed in quantity can be supplied.

Dimensions: Panel (length) 19 x (height) 7 inches; depth behind panel, 12 inches.

Net Weight: 37 $\frac{3}{4}$ pounds.

Type		Code Word	Price
1932-A	Distortion and Noise Meter	TABOO	\$650.00
FRI-412	Aluminum End Frames	ENDFRAMDIG	13.00 Pair

PATENT NOTICE. See Note 15, page x.

TYPE 1932-P1 A-M DETECTOR UNIT



The TYPE 1932-P1 A-M Detector Unit, for measuring the A-M noise level in F-M transmitters, consists of a linear rectifier and an r-f filter, with provision for introducing an audio-frequency calibrating voltage. The detector output, after filtering, is passed through a standard 75-microsecond de-emphasis circuit to the Distortion and Noise Meter. The de-emphasis circuit can be switched out to give a flat characteristic, if desired. A microam-

meter indicates the diode current.

Provision is made for the use of an external diode detector to cover ranges of carrier frequency not included in the normal operating range of the self-contained diode detector.

SPECIFICATIONS

R-F Input: 4 to 8 volts required, from low-impedance line, 50-220 Mc.

Audio Input: 400 cycles; 4 to 8 volts; 1000-ohm input impedance.

Audio Output: 30-30,000 cycles ± 1 db; or 75 μ sec de-emphasis characteristic.

1 to 1.5 volts, into 100 k Ω load.

Diode: 1N34-A Crystal.

Terminals: Telephone jack for a-f voltage; coaxial connector for r-f voltage; plug for inserting into panel jacks of Distortion and Noise Meter; telephone jack for external diode detector.

Accessories Supplied: 1 TYPE 874-C8 Cable Connector.

Mounting: Wrinkle-finish case.

Dimensions: 5 $\frac{1}{4}$ x 6 x 2 $\frac{1}{2}$ inches, over-all.

Net Weight: 1 $\frac{1}{2}$ pounds.

Type		Code Word	Price
1932-P1	A-M Detector Unit.....	AMDET	\$95.00



PARTS AND ACCESSORIES



THE General Radio Company has developed and is constantly improving on a complete line of parts for use in its laboratory and industrial instruments. The design objectives are different from those that govern the design of parts for tv and radio receivers and similar assemblies; among them are unflinching reliability, long life, convenience, excellent appearance, and known electrical characteristics. All General Radio parts are painstakingly designed; they use the best available materials; and production is tooled to yield reasonable prices in consideration of the rigid design requirements. Another important design consideration is to produce integrated groups of basic elements that fit together electrically and have a unity of appearance.

An excellent example of the integrated line is found in General Radio binding posts, coaxial elements, plugs and jacks. Binding posts, for instance, are constructed of brass with Bright-Alloy plate. Bright-Alloy is a high-conducting trimetal plating which does not tarnish easily, will not fingermark, and solders readily. Styrene insulation, in both red and black for color coding, is used because of its high resistivity and exceptionally low loss. The captive top will accept the standard GR TYPE 274 Plug which seats with a taper into the chamfered binding post top to assure mechanical and electrical stability. The insulators are keyed to the binding posts and may be keyed to the panel if desired. They may also be used to mount the TYPE 938 Jack. Both the binding posts and the jack have tips for soldering—no lugs are used as they can introduce an uncertainty of contact.

The TYPE 874 Coaxial Connector introduced by General Radio over 10 years ago, has become an accepted laboratory standard for high-frequency work. An extensive line of coaxial elements using this connector is described in a separate section (Pages 41 to 58). The inner connector is the correct size to accept a TYPE 274 Plug.

The TYPE 274-MB Double Plug is another connector that has become standard equipment in almost all laboratories. The springs of the plugs, as with all TYPE 274 Plugs, are of hardened beryllium-copper, for low contact resistance. The plugs are imbedded, for strength, into a black styrene body, which has a raised ridge along one side so that polarity can be noted by touch. A cross hole provides strain relief from attached leads or cable. To re-

duce the chance of electrical shock, no metal part except the plugs themselves is exposed.

The new TYPE 970 Potentiometers have been designed with particular care to produce an instrument-grade potentiometer at reasonable cost. Care has been taken in the selection of all materials to produce a high degree of mechanical strength and stability coupled with correct electrical design. For example, the smallest practicable size resistance wire is selected to obtain high resolution. These potentiometers are wound by specially designed machines to produce uniformity of spacing and tension on the winding form; the wound form is tightly cemented into the phenolic shell molding, which has cylindrical walls of uniform cross-section so that it will not age out of round. Strong shafts made of glass-reinforced polyester are used, so that the shaft is electrically dead, and the capacitance to ground is correspondingly reduced.

The TYPES 1420 and 1421 Capacitors are of unique design. Both the stator and the rotor sections are made from extruded aluminum stock. The plates are cut from this solid shaped stock by high-precision, ganged circular saws. Thus the complete rotor or stator stack is cut from a homogeneous piece which completely eliminates the contact resistance inherent in the conventional stack construction. Their advantages in stability and mechanical strength are obvious; their electrical characteristics are equally good.

The General Radio knobs are well known for their attractive appearances and mechanical excellence. Shaft holes are bored for precision, and all except the smallest are provided with two set-screws. They are available in a variety of models and sizes and are consistent in style with the binding posts.

Dials are designed to the closest mechanical tolerances, and are available for direct drive, friction drive, and gear drive, with a black matte finish to reduce glare and thus to provide even better readability.

The TYPE 941 Transformer is a general-purpose impedance-matching transformer for general laboratory work in audio and ultrasonic frequencies.

The TYPE 578 Transformer is designed specifically for generator or detector isolation in ac bridge circuits, and has an effective inter-winding capacitance of only 0.3 μf .

Contents of this Section

	<i>Page</i>
Variable Air Capacitors	228
Potentiometers	229
Dials	232
Knobs	234
Transformers	235
Plugs and Jacks	236
Patch Cords and Power Cords	237
Binding Posts	238





VARIABLE AIR CAPACITORS TYPE 1420 AND TYPE 1421



TYPE 1420



TYPE 1421

These capacitors were developed especially for use in laboratory instruments requiring low dielectric losses, low inductance and resistance, and high mechanical and thermal stability. The rotor and stator are each machined from solid, shaped aluminum extrusions of identical alloy. The illustration shows how the one piece stator also serves as a frame for the assembly.

FEATURES:

- Low residual inductance and resistance.
- Good linearity.
- Low temperature coefficient.
- Insulated rotor.
- Sealed, long-life bearings.

SPECIFICATIONS

Capacitance Range:

Type	Nominal		Range for Linear Variation
	Max.	Min.	
1420-F	70	13	54 ± 5μf
1420-G	130	14	108 ± 5μf
1420-H	250	16	216 ± 5μf
1421-J	575	22	540 ± 20μf
1421-K	1120	29	1025 ± 25μf

The rotor-to-ground capacitance is about 1μf for the TYPE 1420 and about 2.5μf for the TYPE 1421. The stator-to-ground capacitance is about 1.5μf for the TYPE 1420, and 4μf for TYPE 1421. The data in the above table are for the capacitor used as a two-terminal device, with rotor grounded. If the stator is grounded, maximum and minimum capacitance values will be decreased by about 1μf.

Linearity: The variation of capacitance with angle of rotation is guaranteed linear within ±0.2% of full scale. The angular range of linear variation is 160°.

Typical linearity is better than ±0.1% for the TYPE 1420, ±0.15% for the TYPE 1421.

Dielectric Losses: For the grounded-rotor connection, the dielectric losses correspond to a D₀C₀ product of less than .01 × 10⁻¹². The rotor-to-ground capacitance has a D₀C₀ product of 0.1 × 10⁻¹². This loss component is in parallel with the main capacitance only for the grounded-stator connection.

Insulation Resistance: Greater than 10¹¹ ohms under standard ASTM laboratory conditions (23°C, 50% RH).

Temperature Coefficient of Capacitance: Approximately +0.003% per degree C.

Shock and Vibration: The TYPE 1420 Capacitors will pass shock and vibration tests of MIL-T-945-A.

Maximum Voltage: 700 volts peak.

Torque: 2 ounce-inches maximum with shaft vertical.

Net Weight: TYPE 1420-F, 4 oz; TYPE 1420-G, 4-½ oz; TYPE 1420-H, 5-½ oz; TYPE 1421-J, 1 lb. 8 oz; TYPE 1421-K, 1 lb. 14 oz.

Dimensions: See sketches below. Where dimensions are critical write for a copy of the latest drawings.

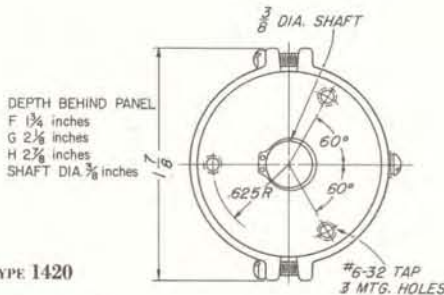

TYPE 1420

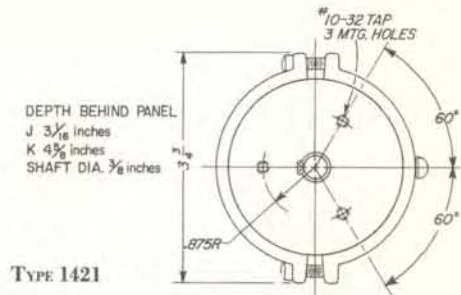

TYPE 1421

Type	Code Word	Price
1420-F	MARRY	\$23.00
1420-G	MATIN	24.00
1420-H	MAXIM	25.00
1421-J	NABIR	46.50
1421-K	NABOB	50.00

See pages 236 to 238 for knobs and dials for use with these capacitors.





970-SERIES POTENTIOMETERS

The 970-Series Potentiometers are moderately priced, high-quality controls with performance approaching the best available. They can be used not only at dc, but also throughout the audio- and ultrasonic-frequency ranges and, in many applications, at low radio frequencies.

DESCRIPTION: The materials used in the all-phenolic body (1), dust-proof cover (2), and glass-reinforced-polyester shaft (3) minimize the capacitance to ground. Low inductance results from the use of a thin winding form of phenolic laminate. A small-diameter brush (4) of precious-metal alloy assures high resolution, since it touches only two wires at a time on the resistor. Brush arm and spring (5) are combined into a single stamping of spring-temper phosphor-bronze. The screw (6) that holds the cover to the base passes through a horseshoe-shaped slot in the brush arm to serve as a rotational stop that exerts no force on the brush. The brush rides with uniform pressure on the firmly anchored wires at the edge of the resistance winding (7). The combination of precious-metal contact, firm track and uniform contact pressure minimizes electrical noise.



The turret terminals (9) are both riveted and soldered to the ends of the winding (7) and to the silver-plated spring-bronze contact take-off in the cover (10), so that none of the fixed internal connections depend on pressure alone.

SPECIAL TYPES

Units in the 970 design can be made on special order with: 360 mechanical rotation, taps as close as $\frac{1}{4}$ inch apart along the entire winding, resistance other than listed values, resistance tapers, resistance tolerance and linearity tolerances better than standard. For applications requiring maximum shaft rigidity, shafts of metal-cored phenolic or of metal can be supplied.

GANGING

When ganged, the 970-Series Potentiometers retain their low-capacitance characteristics. Units are designed to be nested with phenolic spacing rings stacked on a long shaft, and held together with thin metal clamping rings and tie rods. This assembly allows units to be set in any desired phase relationship. Inquiries are welcomed on a special-design basis.

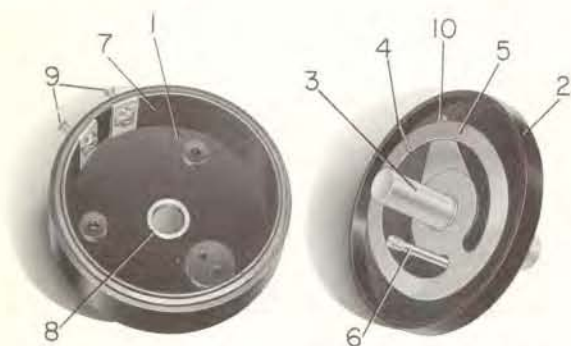

The projecting hub (11) permits adjustment of the shaft with respect to the contact brush while the case is closed. This hub rotates in a reamed brass insert molded into the cover to form a metal-to-metal main bearing close to the plane of the brush. The shaft is rigidly held by this hub, and a second bearing is provided by a stainless-steel insert (8) to guide the shaft in the base. This arrangement provides stable, repeatable settings.

Resistance elements are wound of low-temperature-coefficient alloys. Linearity is assured by uniform turn spacing, on a mandrel that is firmly cemented into the cylindrical base molding.



KNOBS

Recommended knobs for these potentiometers are described on page 234. Use TYPES KNS-6 and KNSP-6 for TYPES 971, 972, 973, and 974; TYPES KNS-8 and KNSP-8 for TYPES 975 and 976; and TYPES KNS-12 and KNSP-12 for TYPES 977 and 978.

Dial plates to fit these potentiometers are listed on page 233.



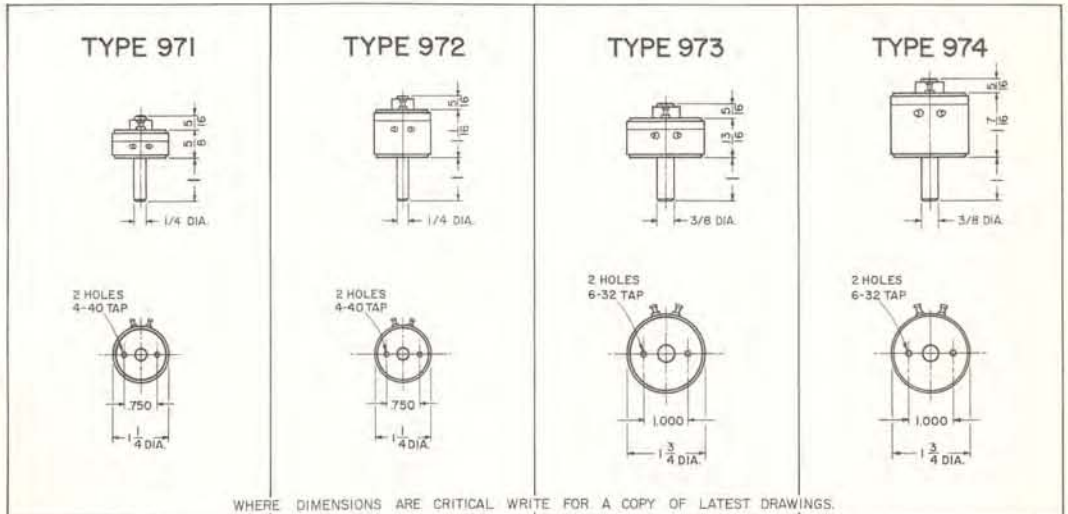

WHERE DIMENSIONS ARE CRITICAL WRITE FOR A COPY OF LATEST DRAWINGS.

APPROXIMATE WEIGHT	1/2 OZ.	APPROXIMATE WEIGHT	3/4 OZ.	APPROXIMATE WEIGHT	1 OZ.	APPROXIMATE WEIGHT	1 3/4 OZ.
EFFECTIVE ELECTRICAL ROTATION	320 \pm 5°	EFFECTIVE ELECTRICAL ROTATION	320 \pm 5°	EFFECTIVE ELECTRICAL ROTATION	320 \pm 5°	EFFECTIVE ELECTRICAL ROTATION	320 \pm 5°
TOTAL MECHANICAL ROTATION	330 \pm 5°	TOTAL MECHANICAL ROTATION	330 \pm 5°	TOTAL MECHANICAL ROTATION	330 \pm 5°	TOTAL MECHANICAL ROTATION	330 \pm 5°
STANDARD RESISTANCE TOLERANCE	\pm 5%	STANDARD RESISTANCE TOLERANCE	\pm 5%	STANDARD RESISTANCE TOLERANCE	\pm 5%	STANDARD RESISTANCE TOLERANCE	\pm 5%
AVERAGE TORQUE	3 1/2 OZ. IN.	AVERAGE TORQUE	3 1/2 OZ. IN.	AVERAGE TORQUE	5 OZ. IN.	AVERAGE TORQUE	5 OZ. IN.

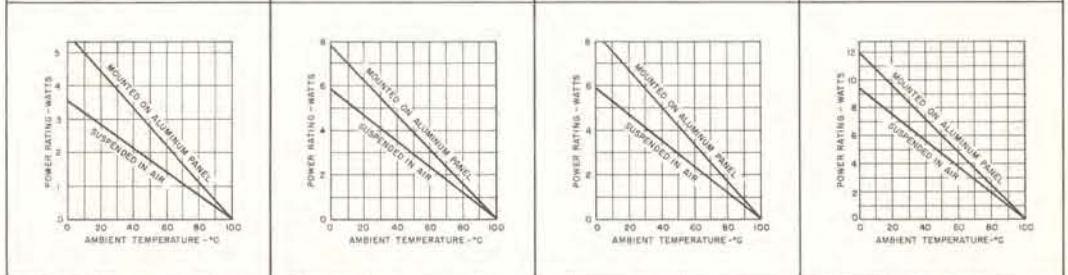

TYPE LETTER	NOMINAL RESISTANCE OHMS	TEMPERATURE COEFFICIENT OF RESISTIVITY	RESOLUTION	INDEPENDENT LINEARITY	TYPE LETTER	NOMINAL RESISTANCE OHMS	TEMPERATURE COEFFICIENT OF RESISTIVITY	RESOLUTION	INDEPENDENT LINEARITY	TYPE LETTER	NOMINAL RESISTANCE OHMS	TEMPERATURE COEFFICIENT OF RESISTIVITY	RESOLUTION	INDEPENDENT LINEARITY	TYPE LETTER	NOMINAL RESISTANCE OHMS	TEMPERATURE COEFFICIENT OF RESISTIVITY	RESOLUTION	INDEPENDENT LINEARITY
B	2				*C	5				*C	5				D	10			
C	5	+0.07%			*D	10	+0.07%	<1%		D	10	+0.07%			E	20	+0.07%		
D	10		<1%		*E	20				E	20		<0.5%		F	50			
E	20				F	50				F	50			<0.5%	G	100			
F	50				G	100				G	100		\pm 0.002%		H	200			
G	100	\pm 0.002%			H	200	\pm 0.002%			H	200	\pm 0.002%			J	500	\pm 0.002%		
H	200			\pm 2%	J	500			\pm 2%	J	500			\pm 1%	K	1000			
J	500		<0.5%		K	1000		<0.5%		K	1000				L	2000			
K	1000				L	2000				L	2000		<0.2%		M	5000			
L	2000				M	5000				M	5000				N	10,000			
M	5000	+0.002%			N	10,000	+0.002%			N	10,000	+0.002%			P	20,000	+0.002%		
N	10,000		<0.2%		P	20,000		<0.2%		P	20,000		<0.1%		Q	50,000			
P	20,000				Q	50,000				Q	50,000				R	100,000			

Type	Code Word	Unit Price	Type	Code Word	Unit Price	Type	Code Word	Unit Price	Type	Code Word	Unit Price
971-B	ANTRIMBITE	\$3.50	971-P	ANTRIMPARK	\$3.50	973-E	CANDIDEARL	\$4.00	974-E	DANCEREARL	\$4.50
971-C	ANTRIMCREW	3.50	972-F	BANTERFALL	3.75	973-F	CANDIDFALL	4.00	974-F	DANCERFALL	4.50
971-D	ANTRIMDULL	3.50	972-G	BANTERGERM	3.75	973-G	CANDIDGERM	4.00	974-G	DANCERGERM	4.50
971-E	ANTRIMEARL	3.50	972-H	BANTERHUNT	3.75	973-H	CANDIDHUNT	4.00	974-H	DANCERHUNT	4.50
971-F	ANTRIMFALL	3.50	972-J	BANTERJUMP	3.75	973-J	CANDIDJUMP	4.00	974-J	DANCERJUMP	4.50
971-G	ANTRIMGERM	3.50	972-K	BANTERKISS	3.75	973-K	CANDIDKISS	4.00	974-K	DANCERKISS	4.50
971-H	ANTRIMHUNT	3.50	972-L	BANTERLEAP	3.75	973-L	CANDIDLEAP	4.25	974-L	DANCERLEAP	5.00
971-J	ANTRIMJUMP	3.50	972-M	BANTERMILK	3.75	973-M	CANDIDMILK	4.25	974-M	DANCERMILK	5.00
971-K	ANTRIMKISS	3.50	972-N	BANTERNULL	3.75	973-N	CANDIDNULL	4.25	974-N	DANCERNULL	5.00
971-L	ANTRIMLEAP	3.50	972-P	BANTERPARK	3.75	973-P	CANDIDPARK	4.25	974-P	DANCERPARK	5.00
971-M	ANTRIMMILK	3.50	972-Q	BANTERQUAD	3.75	973-Q	CANDIDQUAD	4.25	974-Q	DANCERQUAD	5.00
971-N	ANTRIMNULL	3.50	973-D	CANDIDULL	4.00	974-D	DANCERDULL	4.50	974-R	DANCERRISK	5.00



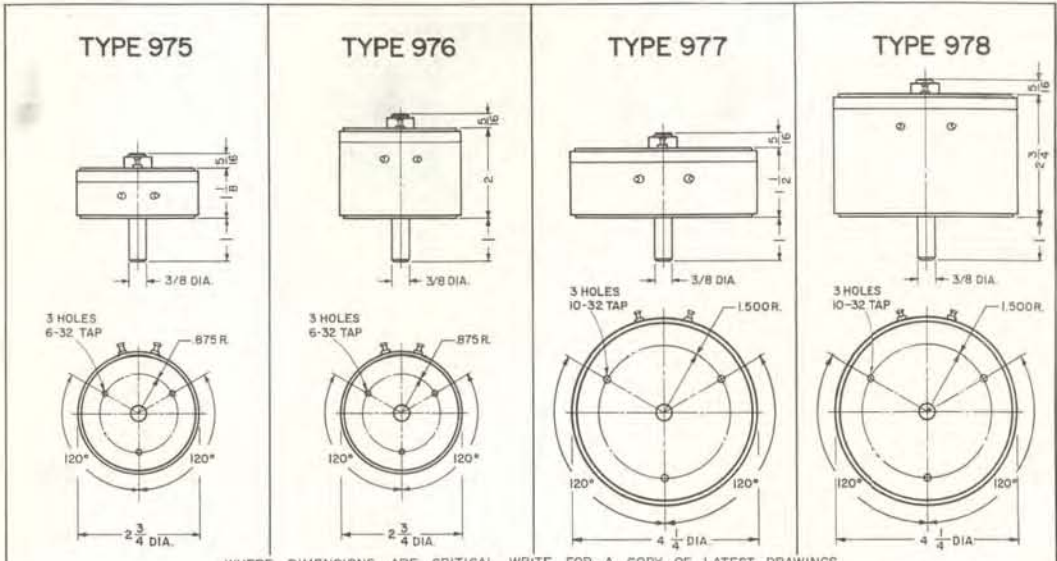

WHERE DIMENSIONS ARE CRITICAL WRITE FOR A COPY OF LATEST DRAWINGS.

APPROXIMATE WEIGHT EFFECTIVE ELECTRICAL ROTATION TOTAL MECHANICAL ROTATION STANDARD RESISTANCE TOLERANCE AVERAGE TORQUE	3 OZ. 320 \pm 2° 330 \pm 5° \pm 2% 8 OZ. IN.	APPROXIMATE WEIGHT EFFECTIVE ELECTRICAL ROTATION TOTAL MECHANICAL ROTATION STANDARD RESISTANCE TOLERANCE AVERAGE TORQUE	4 OZ. 320 \pm 2° 330 \pm 5° \pm 2% 8 OZ. IN.	APPROXIMATE WEIGHT EFFECTIVE ELECTRICAL ROTATION TOTAL MECHANICAL ROTATION STANDARD RESISTANCE TOLERANCE AVERAGE TORQUE	9 OZ. 320 \pm 2° 330 \pm 5° \pm 2% 12 OZ. IN.	APPROXIMATE WEIGHT EFFECTIVE ELECTRICAL ROTATION TOTAL MECHANICAL ROTATION STANDARD RESISTANCE TOLERANCE AVERAGE TORQUE	12 OZ. 320 \pm 2° 330 \pm 5° \pm 2% 12 OZ. IN.
---	--	---	--	---	---	---	--

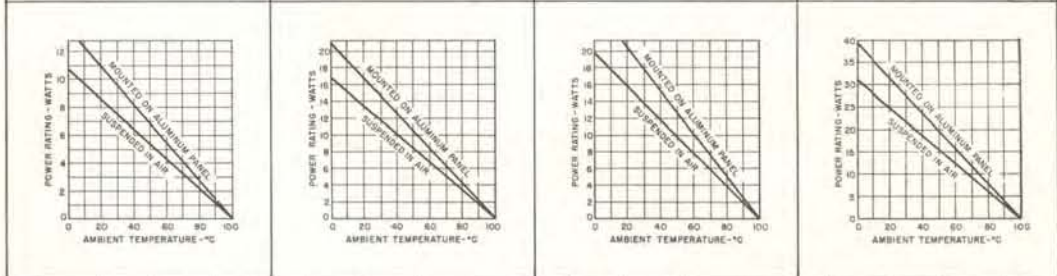

TYPE LETTER	NOMINAL RESISTANCE OHMS	TEMPERATURE COEFFICIENT OF RESISTIVITY	RESOLUTION	INDEPENDENT LINEARITY	TYPE LETTER	NOMINAL RESISTANCE OHMS	TEMPERATURE COEFFICIENT OF RESISTIVITY	RESOLUTION	INDEPENDENT LINEARITY	TYPE LETTER	NOMINAL RESISTANCE OHMS	TEMPERATURE COEFFICIENT OF RESISTIVITY	RESOLUTION	INDEPENDENT LINEARITY	TYPE LETTER	NOMINAL RESISTANCE OHMS	TEMPERATURE COEFFICIENT OF RESISTIVITY	RESOLUTION	INDEPENDENT LINEARITY
*D	10	+0.07%			*E	20	+0.07%			*E	20	+0.07%			*F	50	+0.07%		
*E	20				*F	50				*F	50				*G	100		<0.5%	\pm 1%
*F	50		<0.5%	\pm 1%	*G	100		<0.5%	\pm 1%	*G	100		<0.2%	\pm 0.5%	*H	200		<0.2%	\pm 0.5%
*G	100				*H	200				*H	200				*J	500			
*H	200				*J	500				*J	500				*K	1000			
J	500	\pm 0.002%			K	1000	\pm 0.002%			K	1000	\pm 0.002%			*L	2000			
K	1000		<0.2%		L	2000		<0.2%		*L	2000		<0.1%		*M	5000		<0.1%	
L	2000				M	5000				*M	5000				N	10,000			
M	5000				N	10,000			\pm 0.5%	N	10,000				*P	20,000			
N	10,000		<0.1%	\pm 0.5%	P	20,000		<0.1%		*P	20,000				*Q	50,000			
P	20,000	\pm 0.002%			Q	50,000	\pm 0.002%			*Q	50,000	\pm 0.002%			R	100,000			
Q	50,000				R	100,000				R	100,000		<0.05%		*R	100,000			
R	100,000		<0.05%		T	200,000		<0.05%		*T	200,000				*T	200,000			
															U	500,000			

* NOT USUALLY MANUFACTURED OR STOCKED. INQUIRIES ARE INVITED.

Type	Code Word	Unit Price	Type	Code Word	Unit Price	Type	Code Word	Unit Price
975-J	EAGLETJUMP	\$4.75	976-K	FANGELKISS	\$5.50	976-T	FANGELTICK	\$6.50
975-K	EAGLETKISS	4.75	976-L	FANGELLEAP	5.50	977-K	GANDERKISS	6.00
975-L	EAGLETLEAP	4.75	976-M	FANGELMILK	5.50	977-N	GANDERNULL	6.75
975-M	EAGLETMILK	4.75	976-N	FANGELNULL	6.00	977-R	GANDERRISK	6.75
975-N	EAGLEYNULL	5.25	976-P	FANGELPARK	6.00	978-N	HAMPERNULL	7.75
975-P	EAGLETPARK	5.25	976-Q	FANGELQUAD	6.00	978-R	HAMPERRISK	7.75
975-Q	EAGLETQUAD	5.25	976-R	FANGELRISK	6.00	978-U	HAMPERULNA	12.50
975-R	EAGLETRISK	5.25						

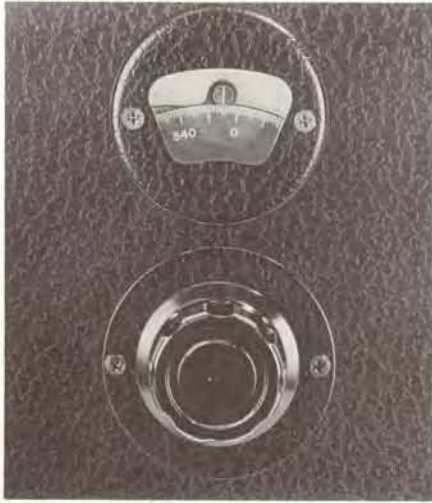

TYPE 907-WB

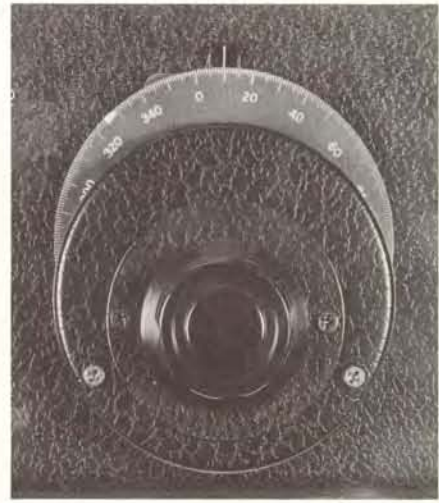

TYPE 907-WA

GEAR-DRIVE PRECISION DIALS

The TYPE 907 and 908 Gear-Drive Precision Dials have aluminum dial plates with black anodized finish. Scales are individually engraved on an automatic, self-indexing engraving machine. The fine, radial, accurately located lines divide the complete circumference into 360 divisions numbered from 0 to 360.

Settings can be consistently duplicated to one-fifth of a division, allowing a precision of resetting of better than 0.06% of full scale. Parallax is eliminated by the use of an indicator that always remains flush with the surface of the dial, and which at the same time absorbs, through the flexibility of its mounting arm, any slight eccentricities of the main shaft.

The ring gear and drive pinion are precision-cut gears, spring pressed to eliminate any backlash. The drive ratio is 10:1, and it is possible to use a calibrated vernier or increment dial on the pinion shaft if desired. Any standard TYPE 901 dial (page 233) can be adapted for use on the pinion shaft. The drive pinion is held in a stainless-steel collet, which runs in a phosphor-bronze bushing. The collet allows

the drive to be adjusted for any panel thickness up to $\frac{5}{16}$ inch.

The main dials are set permanently and securely to their shafts through the use of two set-screws 90° apart; this procedure eliminates any dial backlash that might otherwise occur. The dial hubs are bored to receive a $\frac{3}{8}$ -inch shaft, but a bushing is furnished for use with $\frac{1}{4}$ -inch shafts.

The dial indicator, knob, and all necessary mounting parts are supplied, as are complete drilling and mounting instructions.

MOTOR DRIVES—Motor drives for attachment to these dials are described on page 212.

Motor drive attached to a 908-type dial on the TYPE 1304-B Beat-Frequency Audio Generator.



Type	Mounting	Dial		Max. Panel Thickness	Total Panel Area	Net Weight	Code Word	Price
		Arc	Divisions					
➤ 4-INCH DIAMETER GEAR-DRIVE PRECISION DIALS								
907-WA	Front-of-Panel	360°	360	—	4 × 5 inches	11 oz.	DITAB	\$10.50
907-WB	Back-of-Panel	360°	360	$\frac{5}{16}$ inch	4 × 5 inches	11 oz.	DITOP	10.50
➤ 6-INCH DIAMETER GEAR-DRIVE PRECISION DIALS								
908-WA	Front-of-Panel	360°	360	—	6 × 7½ inches	21 oz.	DIVAT	\$14.50
908-WB	Back-of-Panel	360°	360	$\frac{5}{16}$ inch	6 × 7½ inches	19 oz.	DIVIM	14.50

PATENT NOTICE. See Note 13, page x.





FRICTION-DRIVE AND DIRECT-DRIVE DIALS



TYPE 904-VF



TYPE 902-TF



TYPE 901-WD

Approx.
1/2 size

These dials are attractive in appearance, with accurate, photo-etched scales, and are intended for uses where precisely cut scales and precision drives are not needed. Dial plates are of aluminum, with black anodized finish.

The friction-drive mechanism, which is available on the 2 3/4-inch and 4-inch sizes, consists of a thin disc, which is mounted on the back of the dial plate, gripped and driven by two small discs attached to the friction-drive shaft. The tension of the drive can be easily

adjusted after installation.

Dials are insulated from the shaft. Knobs are secured to their shafts by the use of two setscrews separated by 90° and are supplied bored to receive a 3/8-inch shaft. Bushings are supplied for use on 1/4-inch shafts.

The indicators shown in the photographs are designed to remain flush with the surface of the dial, thus eliminating parallax and absorbing any slight eccentricities of the main shaft. Indicators, mounting screws, drive knobs, and drilling templates are furnished.

Type	Dial		Drive	Net Weight	Code Word	Price
	Arc	Divisions				
➤ 2-INCH DIAMETER—TYPE 901 DIALS						
901-TD	180°	100	Direct	2 oz.	DILOG	\$2.30
901-VD	270°	100	Direct	2 oz.	DILAP	2.30
901-WD	360°	100	Direct	2 oz.	DILID	2.30
➤ 2 3/4-INCH DIAMETER—TYPE 902 DIALS						
902-TD	180°	100	Direct	2 1/2 oz.	DIMAP	\$2.50
902-VD	270°	100	Direct	2 1/2 oz.	DIMID	2.50
902-TF	180°	100	Friction, 3.3:1	4 oz.	DIMOB	4.00
902-VF	270°	100	Friction, 3.3:1	4 oz.	DIMUG	4.00
➤ 4-INCH DIAMETER—TYPE 904 DIALS						
904-TF	180°	100	Friction, 5:1	8 oz.	DIPEN	\$5.50
904-VF	270°	200	Friction, 5:1	8 oz.	DIPUT	5.50

PATENT NOTICE. See Note 13, page x.

DIAL PLATES FOR 970-SERIES POTENTIOMETERS

The 4-inch and 2 3/4-inch sizes are reversible; one side for use as dial plate, with pointer-type knob; the other side for use as dial, attached to knob. The 2-inch size is single side, for dial plate only. Photos show, left to right, dial-plate side of 970-P3, dial side of 970-P2, and 970-P1 (dial plate only). Scales cover full angle of winding —320°.



Type	Dia.	Use With Type	Code Word	Price
970-P1	2"	971, 972, 973, 974	DIPAL	\$0.20
970-P2	2 3/4"	975, 976	DIPOT	.45
970-P3	4"	977, 978	DIPUG	.65

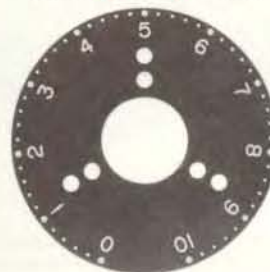



TYPE KN FLUTED KNOBS

These black phenolic knobs are used on General Radio laboratory instruments. Each is molded in one piece with a brass insert bored for a $\frac{3}{8}$ -inch shaft except the TYPE KN5P-1, which is reamed for a $\frac{1}{4}$ -inch shaft.



TYPE KNB-1

TYPE KNB-2



TYPE KN5P-1



TYPE KN5P-6



TYPE KN5P-8



TYPE KN5P-10



TYPE KNS-12

The TYPE KN Fluted Knobs are shown approximately three-eighths actual size in the photograph.

A bushing is furnished with each of the others to adapt it to a $\frac{1}{4}$ -inch shaft. Knob is clamped to shaft by two set-screws spaced 90° apart, except in TYPE KN5P-6 and KNS-6, which have 135° spacing. TYPE KNB-1 has single set-screw.

TYPE KNB-1 $\frac{1}{16}$ " SKIRT DIA WITH BAR

TYPE KNB-2 $\frac{1}{16}$ " SKIRT DIA WITH BAR

Bar-Type especially convenient on switches.

Unit Price†	5*-19	20-	200-	400-	2000
In lots of		199	399	1999	up
TYPE KNB-1	\$0.80	\$0.70	\$0.65	\$0.60	\$0.57
TYPE KNB-2	\$0.85	\$0.74	\$0.69	\$0.63	\$0.60

Code Word: KNB-1, BARKNOBONE Weight for 5: $3\frac{3}{4}$ oz.

Code Word: KNB-2, BARKNOBTWO Weight for 5: 6 oz.

TYPE KN5P-1 $\frac{1}{16}$ -INCH SKIRT DIA

Unit Price†	5*-19	20-	200-	400-	2000
In lots of		199	399	1999	up
TYPE KN5P-1	\$0.60	\$0.52	\$0.48	\$0.44	\$0.42

Code Word: NURLNOBEN Net Weight for 5: 6 oz.

TYPE KN5P-6 WITH POINTER $\frac{1}{16}$ " SKIRT DIA

TYPE KNS-6 WITHOUT POINTER

Unit Price†	5*-19	20-	200-	400-	2000
In lots of		199	399	1999	up
KN5P-6 or KNS-6	\$0.60	\$0.52	\$0.48	\$0.44	\$0.42

Code Words: KN5P-6, NURLNOBSIX

KNS-6, NURLNOBOUT Net Weight for 5: $5\frac{1}{2}$ oz.

TYPE KN5P-8 WITH POINTER $1\frac{1}{16}$ " SKIRT DIA

TYPE KNS-8 WITHOUT POINTER

Unit Price†	5*-19	20-	200-	400-	2000
In lots of		199	399	1999	up
KN5P-8 or KNS-8	\$0.70	\$0.62	\$0.58	\$0.54	\$0.52

Code Words: KN5P-8, NURLNOBATE

KNS-8, NURLNOBOAF Net Weight for 5: 8 oz.

TYPE KN5P-10 WITH POINTER $2\frac{1}{4}$ " SKIRT DIA

TYPE KNS-10 WITHOUT POINTER

Unit Price†	5*-19	20-	200-	400-	2000
In lots of		199	399	1999	up
KN5P-10 or KNS-10	\$1.05	\$0.92	\$0.86	\$0.78	\$0.75

Code Words: KN5P-10, NURLNOBTEN

KNS-10, NURLNOBORB Net Weight for 5: $12\frac{1}{2}$ oz.

TYPE KN5P-12 WITH POINTER $2\frac{7}{8}$ " SKIRT DIA

TYPE KNS-12 WITHOUT POINTER

Unit Price†	5*-19	20-	200-	400-	2000
In lots of		199	399-	1999-	up
KN5P-12 or KNS-12	\$1.25	\$1.12	\$1.06	\$0.98	\$0.95

Code Words: KN5P-12, NURLNOBGIG

KNS-12, NURLNOBDOZ Net Weight for 5: 17 oz.

PATENT NOTICE. See Note 13, page x.

*Minimum quantity sold.

†Net. No further quantity discounts.

TYPE 578 SHIELDED TRANSFORMER

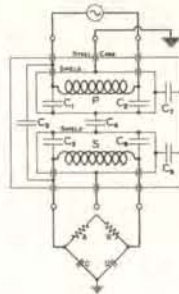

Grounded bridge supplied through a double-shielded transformer. When case is grounded, the capacitance placed across each capacitance arm is 40 μf . Note that the winding shield on the bridge side is *not* grounded, but is floating.

This transformer is used in direct-reading ac bridges to isolate the bridge circuit from changes in electrostatic potential in the generator (or detector) circuit and to reduce the effect of the capacitance of the external circuit to ground. It can also be used to isolate any measuring circuit from the generator or detector, or to produce a balanced output from a grounded generator.

Three shields are used, one around each winding and a third to bring the core laminations to the potential of the case.

SPECIFICATIONS

Turns Ratio: 4 to 1 or 1 to 4.

Ranges: See price table.

Capacitances: See drawing.

C_1, C_2, C_5, C_6	each 200 μf
C_3	0.3 μf
C_7, C_8	each 70 μf
C_4	30 μf

Winding Inductance: Turns squared (see table) multiplied by 3.5×10^{-6} henrys, approx.

D-C Resistance: (In ohms) 30 times inductance in henrys, approx.

Voltage Limits: The high-impedance winding of TYPES 578-A or -B may be connected directly across a 115-volt 50- to 60-cycle line if the impedance connected to the other winding equals or exceeds the lowest value given under "low impedance" in the table below. The TYPE 578-B may be used at 25 cycles under the same conditions.

For TYPES 578-A or -B, the low-impedance winding may be connected directly to a 115-volt, 50- to 60-cycle line provided that the resistance across the high-impedance winding exceeds 10,000 ohms. The TYPE 578-B may be used at 25 cycles under the same conditions.

Insulation: The insulation from winding to winding and from windings to case will withstand 1000 volts, peak.

Dimensions: Base, $3\frac{1}{8} \times 2\frac{1}{16}$ inches; height, $4\frac{1}{8}$ inches.
Net Weight: $2\frac{1}{2}$ pounds.

TYPE 941-A TOROIDAL TRANSFORMER



FOR IMPEDANCE MATCHING OR BRIDGING IN LOW-LEVEL 600-COMMUNICATION CIRCUITS

This transformer has highly astatic windings and tight coupling. The toroidal core is a spiral of high-permeability-alloy tape. Identical pairs of windings on each half of the toroid minimize pickup and induction field, while close coupling between inner and outer windings keeps leakage reactance low and extends high-frequency response.

SPECIFICATIONS

Frequency and Impedance Ranges:

Terminating Impedances	Frequency for 1 db drop	Flat Insertion Loss Less than
600 Ω	9600 Ω	80 c—100 kc
600 Ω	2400 Ω	20 c—135 kc
600 Ω	2400 Ω	80 c—340 kc
600 Ω	600 Ω	20 c—200 kc
150 Ω	600 Ω	5 c—50 kc
150 Ω	600 Ω	20 c—200 kc
37.5 Ω	600 Ω	5 c—50 kc

Zero-Signal Inductance: Inner windings, in series, 5 to 6 henrys; outer windings, in series, 20 to 24 henrys.

Voltage Matching: Inner windings, 0.015% or better; outer windings, 0.08% or better.

Operating Level and Distortion:

Watts	dbm	r-m-s distortion, 60c
1.26	31	<1%
1	30	<0.5%
0.5	27	<0.2%
0.032	15	<0.1%

Resistance: Inner windings, in series, 9 ohms; outer windings, in series, 34 ohms.

Dimensions: Aluminum case, $3\frac{5}{8} \times 3\frac{1}{8} \times 1\frac{5}{8}$ inches. Mounting blocks project $\frac{1}{32}$ inch beyond case in $3\frac{1}{8}$ inch dimension. Mounting holes are $3\frac{3}{8}$ inches on centers and are drilled for clearance with 10-32 machine screws.
Net Weight: $13\frac{1}{2}$ ounces.

Type	Code Word	Price
941-A	TRANTORCAT	\$45.00

Impedance Range*

Type	Turns	Frequency Range*	Low-Impedance Winding	High-Impedance Winding	Code Word	Price
578-A	600 to 2400	50 cycles to 10 kc	50 Ω to 5 k Ω	1 k Ω to 100 k Ω	TABLE	\$25.00
578-B	1000 to 4000	20 cycles to 5 kc	60 Ω to 6 k Ω	1.2 k Ω to 120 k Ω	TENOR	25.00
578-C	60 to 240	2 kc to 500 kc	20 Ω to 2 k Ω	0.4 k Ω to 40 k Ω	TEPID	25.00

*These ranges are for transmission within 6 db. At extremes of both impedance and frequency ranges, the transmission may be down by 12 db.



TYPE 274 PLUGS AND JACKS

TYPE 274 Plugs and Jacks, originated by General Radio in 1924, are almost universally used in electronics and communications laboratories for connecting equipment in temporary or semi-permanent setups and for connecting plug-in elements in tuning systems and other laboratory instruments. All TYPE 274 Plugs and Jacks are rated

at 15 amperes. Plugs have nickel-plated brass stud, beryllium copper springs. Jacks are nickel-plated brass. These plugs and jacks are designed for positive and reliable contact. The plug seats firmly in the jack so that the plug springs are not depended upon for mechanical stability.

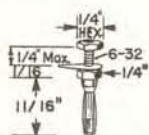

TYPE 274-P PLUG

Fits TYPE 274-J Jack.
Furnished with nut and soldering lug.
Code Word: STANPARCAT

Quantity	Unit Price †
10* - 99	\$0.13
100 - 999	0.11
1000 - 1999	0.10
2000 up	0.09

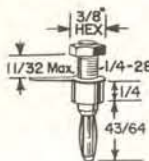

TYPE 274-U PLUG

Fits TYPE 274-J Jack.
1/4-28 threaded stud. Jack top accepts TYPE 274 Plug. Code Word: STANPARGOT

Quantity	Unit Price †
10* - 99	\$0.20
100 - 999	0.18
1000 - 1999	0.17
2000 up	0.16



TYPE 274-J JACK

Fits TYPE 274 Plugs. Nickel-plated brass. Code Word: STANPARTOP

Quantity	Unit Price †
10* - 99	\$0.08
100 - 999	0.07
1000 - 1999	0.06
2000 up	0.05

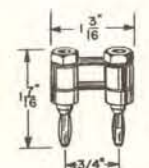

TYPE 274-SB SHORT-CIRCUIT PLUG

Handy for shorting two terminals. Consists of two TYPE 274-U Plugs connected by two plated links.

Code Word: STANPARZIP Price: \$0.75

TYPE 274-DB INSULATED SINGLE PLUGS

Red or black styrene-insulated plug with jack top; set screw clamp on plug end for wire or telephone tip.

TYPE 274-DB1 (black) Code Word: STAPLUGANT

TYPE 274-DB2 (red) Code Word: STAPLUGARC



Quantity	Unit Price †
5* - 9	\$0.50
10 - 99	0.43
100 - 199	0.40
200 - 999	0.36
1000 up	0.34

TYPE 274-MB INSULATED DOUBLE PLUG

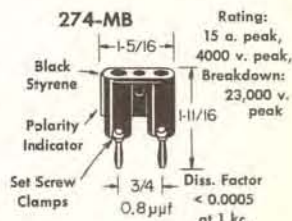

Attractively designed, molded-styrene double-plug assembly for rapid and convenient connections in the laboratory. Fits TYPE 938 Binding Posts and TYPE 274 Jacks on standard 3/4-inch spacing; jack top permits stacking for multiple connections. Low capacitance, low losses, completely insulated for hand protection, polarity indication molded in. A cross hole through the center provides strain relief for attached cables up to 0.2-inch diameter.

Code Word: STANPARBUG



Quantity	Unit Price †
5* - 9	\$0.65
10 - 99	0.57
100 - 199	0.54
200 - 999	0.49
1000 up	0.47

TYPE 274-NK SHIELDED DOUBLE PLUG

Double plug in anodized aluminum case with ceramic insulation for completely shielded connections to a pair of TYPE 938 Binding Posts. Provides strain relief for coaxial cable of 0.20 and 0.25 inch O.D. This plug terminates the TYPE 274-NL Patch Cord (page 237) and the TYPE 874-R34 Patch Cord (page 56).

Code Word: STAPLUGNUT

Price: \$1.35

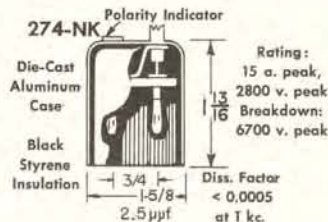

ADAPTORS

TYPE 274-QBJ ADAPTOR

Shielded banana plugs provide connection from binding post terminals to a TYPE BNC plug.

Code Word: STANPARMUG

Price: \$2.50

* Minimum quantity sold. † Net prices. No further quantity discounts.



Code Word: COAXCHOSER

TYPE 874-QN6 ADAPTOR

Fits TYPE 274-NO Universal Patch Cord to connect from banana plug terminals to TYPE 874 Coaxial System.

Price: \$1.00



PATCH CORDS

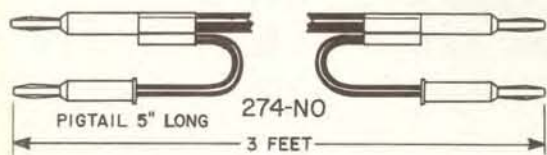

The TYPE 274-NO Patch Cord terminates in GR TYPE 274 Plugs, and is the basic unit of an extremely versatile system of connectors. By use of available adaptors and plugs, connections can be made to General Radio TYPE 874 Coaxial Elements, and General Radio TYPE 938-B Clips, Army-Navy type N, BNC, C, HN, and UHF coaxial connectors, and VHF and UHF transmission lines are all accommodated through the TYPE 874 Coaxial Adaptors on page 58. These connections can be made with a minimum number of units, permitting maximum flexibility from a given patch cord and connector assortment.

The photograph at the right indicates how the TYPE 274-NO Patch Cord is attached to the TYPE 838-B Alligator Clips, the TYPE 938 Binding Posts, the TYPE 874-QN6 Adaptor and the TYPE 274-NT Shield.

Capacitance 95 μf
3a peak, rating
1200 v peak, rating
3400 v peak, breakdown.

TYPE 274-NO

UNIVERSAL

PATCH CORD

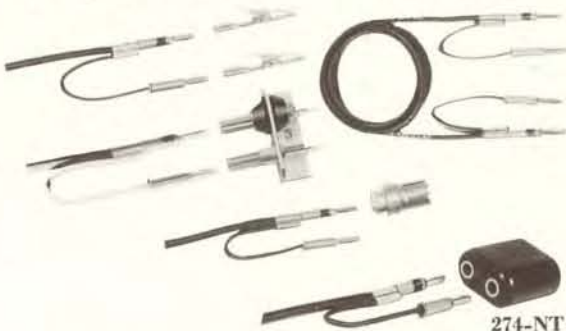

274-NT

Type	Code Word	Price
274-NO Patch Cord	STANPARKID	\$3.25
274-NT Shield	STANPARTAD	.90



TYPE 274-NP

PATCH CORD

The TYPE 274-NP is a three-foot shielded lead terminated with double plugs which are permanently attached.

Type	Code Word	Price
274-NP Patch Cord	STANPARYAK	\$3.50



TYPE 274-NL

PATCH CORD

The TYPE 274-NL is a shielded lead, three feet long, terminated with TYPE 274-NK shielded double plugs which are permanently attached.

Type	Code Word	Price
274-NL Patch Cord	STAPLUGBAT	\$4.50

POWER CORDS

These power cords are rubber-covered No. 18 conductors, 7 feet long, with plug and connector bodies molded integrally with the rubber-covered cord. The 2-wire

TYPE CAP-35 2-WIRE POWER CORD

TYPE SJ cord rated by Underwriters Laboratories at 7 amperes and 300 v, rms. Female connector fits either standard 2-wire or new 3-wire plug.

TYPE CAP-15 3-WIRE POWER CORD

Electrical ratings are 7 amperes and 125 v. The connectors conform to the American Standard for Grounding Type Attachment Plug Caps and Receptacles.

TYPE 109-A 3-WIRE RECEPTACLE

Interchangeable with the standard 2-wire receptacle to provide a 3-contact power input receptacle which accepts either standard 2-wire or new 3-wire power cords.

power cord is supplied with General Radio ac operated instruments, the 3-wire cord may be purchased where grounded connections are desirable.

TYPE 109-A
Receptacle (right).(above) TYPE CAP-35.
(right) TYPE CAP-15.

Type	Code Word	Price
CAP-35 2-Wire Power Cord	CORDY	\$1.75
CAP-15 3-Wire Power Cord	TRICO	2.25
109-A 3-Wire Receptacle	TRIPU	1.25





TYPE 938 BINDING POST

WITH THE ELECTRICAL AND MECHANICAL PROPERTIES NEEDED FOR MODERN ELECTRONIC INSTRUMENTS

THE TYPE 938 Binding Post combines excellent electrical properties and ingenious mechanical design. Materials are carefully chosen for their electrical and mechanical properties—brass with Bright-Alloy plate for high conductivity, and styrene insulation for high resistance and low power factor, either red or black for color coding.

It can be mounted on metal or insulating panels, of a thickness from zero to $\frac{5}{16}$ inch. Mechanical details and methods of connection are shown below.

The binding post has the same height above panel as the TYPE 874 Coaxial Connector (see page 57), whose center will take a TYPE 274 Plug, so that a grounded binding post can be mounted adjacent to the coaxial connector to fit a TYPE 274-MB Double Plug.

PATENT NOTICE. See Note 3, page x.

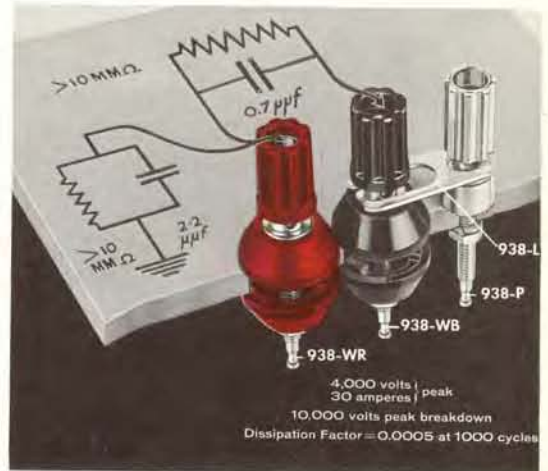

Type	Code Word	Unit Prices† 10*–99	100– 999	1000– 1999	2000– up
938-P Metal top, 938-F Spacer	STANPARDOT	\$0.40	\$0.36	\$0.34	\$0.32
938-R Metal top, red Insulators	STANFARGIG	.46	.41	.38	.35
938-W Metal top, black Insulators	STANPARANT	.46	.41	.38	.35
938-WB Black top and black Insulators	STANPARBAN	.54	.47	.44	.40
938-WR Red top and red Insulators	STANPARCUB	.54	.47	.44	.40

* Minimum quantity sold.

† Net prices. No further quantity discounts.

The above binding post combinations are shipped unassembled. When assembly and/or individual packaging before shipment is required, add 5¢ per binding post for each operation.

MECHANICAL DETAILS

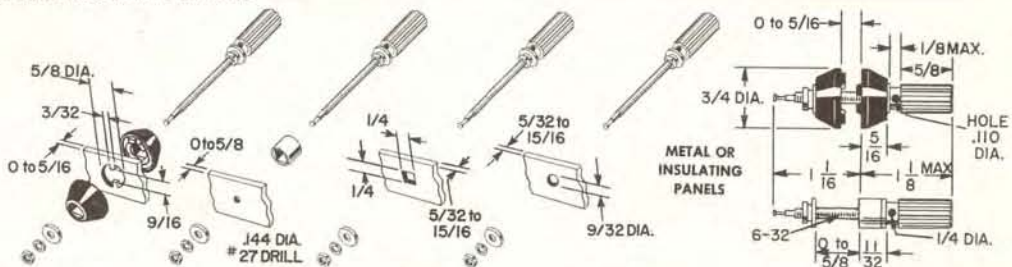

Locking keys in $\frac{5}{8}$ -inch mounting holes can be omitted if locking feature is not wanted.

METHODS OF CONNECTION

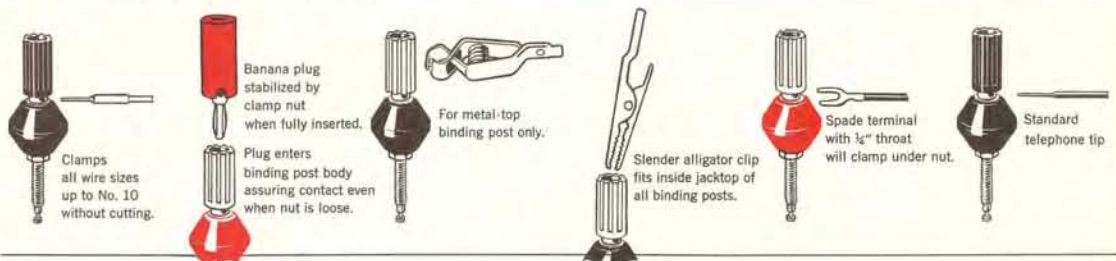



Binding posts and insulators are available separately. The insulators also will mount

a TYPE 938 Jack, see below. Both binding post and jack have soldering tips—no lugs are used.

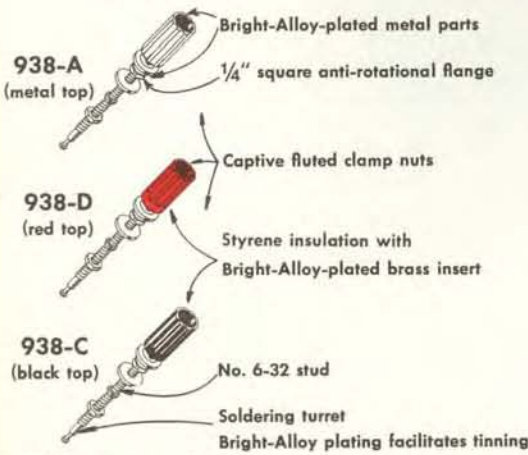

PATENT NOTICE. See Note 3, page x.

Type	Code Word	Unit Prices†	100- 10*-99	1000- 999	2000- up
938-A Metal-Top Binding Post	STANPARASP	\$0.32	\$0.29	\$0.27	\$0.25
938-C Black-Top Binding Post	STANPARAWL	.40	.35	.33	.30
938-D Red-Top Binding Post	STANPARARM	.40	.35	.33	.30
938-BB Black Insulators (Pair)	STANPARAUK	.14	.12	.11	.10
938-BR Red Insulators (Pair)	STANPARATE	.14	.12	.11	.10
938-F Spacer	STANPARBON	.08	.07	.07	.07

OTHER ACCESSORIES FOR TYPE 938 BINDING POSTS

▶ **TYPE 938-YB INSULATORS**

These insulators mount two binding posts, and are particularly easy to assemble, since 3/4-inch spacing is maintained without exact machining. Mount in 1/2" dia. holes.

Type	Code Word	10- 99	100- 999	1000- 1999	2000- up
938-YB Insulator	STANPARPAN	\$0.20	\$0.18	\$0.16	\$0.15

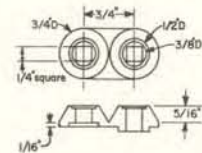

▶ **TYPE 838-B ALLIGATOR CLIP**



Slender-nose clip that fits inside jack top of all TYPE 938 Binding Posts.

Type	Code Word	Unit Prices†	100- 10*-99	200- 199	1000- 999	up
838-B Alligator Clip	STANPARNIP	\$0.15	\$0.14	\$0.13	\$0.12	
938-L Shorting Link	STANPARBET	.10	.09	.09	.09	

▶ **TYPE 938-L SHORTING LINK**

Bright-Alloy-plated brass

Captive link for rapidly connecting or disconnecting binding posts mounted on 3/4" centers



938-L

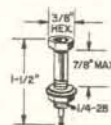

▶ **TYPES 938-J JACK AND 938-X JACK ASSEMBLY**

A jack and jack assembly using TYPE 938-BB Insulators. Jack is similar to TYPE 274-J Jack, but with longer shank. Fits TYPE 274 Plugs.

Type	Code Word	Unit Prices†	100- 10*-99	1000- 999	2000- up
938-J Jack	STANPARACT	\$0.32	\$0.27	\$0.25	\$0.22
938-XB Jack Assembly, Black Ins.	STANPARART	.46	.39	.36	.32
938-XR Jack Assembly, Red Ins.	STANPARHIT	.46	.39	.36	.32

* Minimum quantity sold. † Net prices. No further quantity discounts.

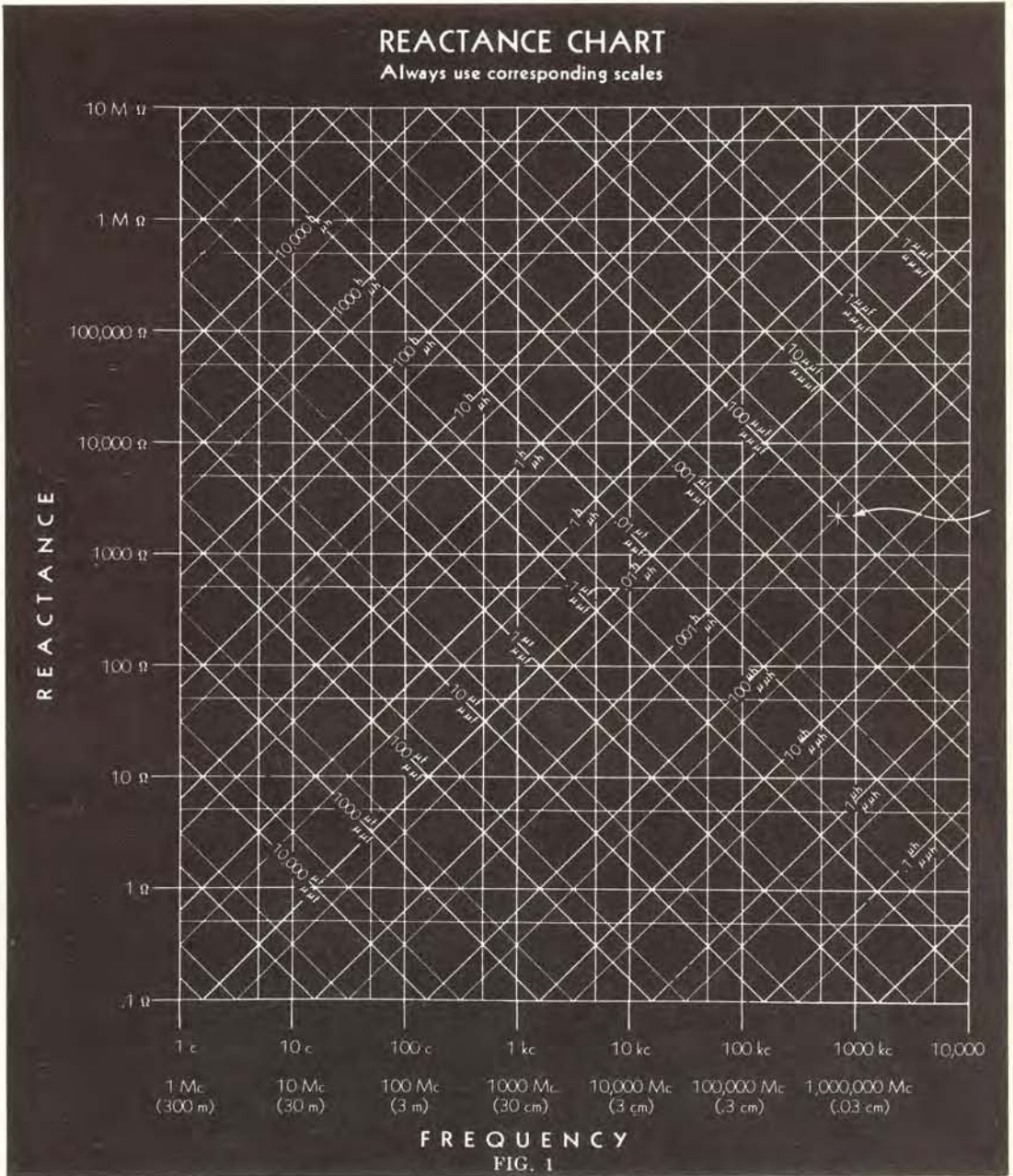

The accompanying chart may be used to find:

- (1) The reactance of a given inductance at a given frequency.
- (2) The reactance of a given capacitance at a given frequency.
- (3) The resonant frequency of a given inductance and capacitance.

In order to facilitate the determination of magnitude of the quantities involved to two or three significant figures the chart is divided into two parts. Figure 1 is the complete chart to be used for rough calculations. Figure

2, which is a single decade of Figure 1 enlarged approximately 7 times, is to be used where the significant two or three figures are to be determined.

TO FIND REACTANCE

Enter the charts vertically from the bottom (frequency) and along the lines slanting upward to the left (capacitance) or to the right (inductance). Corresponding scales (upper or lower) must be used throughout. Project horizontally to the left from the intersection and read reactance.

Write for Enlarged Copies of These Charts



Always obtain approximate value from Figure 1 before using Figure 2

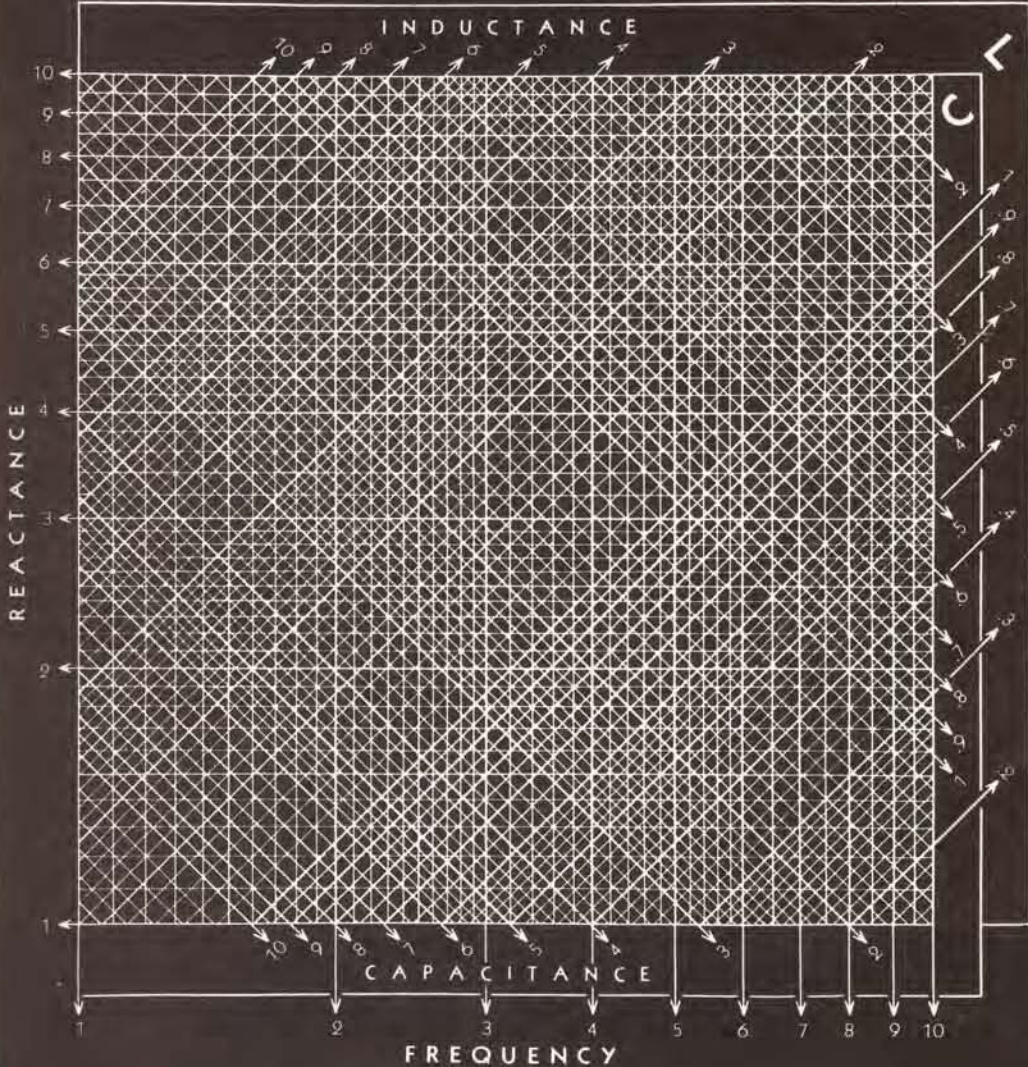

FIG. 2

TO FIND RESONANT FREQUENCY

Enter the slanting lines for the given inductance and capacitance. Project downward from their intersection and read resonant frequency from the bottom scale. Corresponding scales (upper or lower) must be used throughout.

Example: The sample point indicated (Figure 1) corresponds to a frequency of about 700 kc and an inductance of 500 μ h, or a capacitance of 100 μ mf, giving in either case a reactance of about 2000 ohms. The resonant frequency of a circuit containing these values of inductance and capacitance is, of course, 700 kc, approximately.

USE OF FIGURE 2

Figure 2 is used to obtain additional precision of reading but does not place the decimal point which must be located from a preliminary entry on Figure 1. Since the chart necessarily requires two logarithmic decades for inductance and capacitance for every single decade for frequency and reactance, unless the correct decade for L and C is chosen, the calculated values of reactance and frequency will be in error by a factor of 3.16.

Example: (Continued.) The reactance corresponding to 500 μ h or 100 μ mf is 2230 ohms at 712 kc, their resonant frequency.



SMITH CHARTS

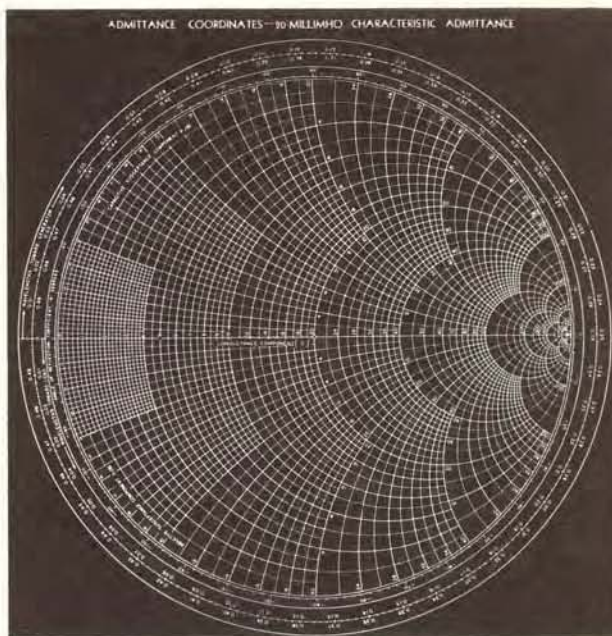

In measurements on transmission-line circuits, it is often necessary to determine, or to correct for, the impedance transformation produced by a length of line. Transmission-line equations can be used to make the calculation, but the process is laborious. A chart with which the calculations can be made graphically with very little effort has been devised by P. H. Smith¹ and is known as the Smith chart. In many cases valuable information can be gained by directly plotting a series of measurements on the chart. In addition to the application indicated above, the chart can be used to determine the VSWR corresponding to any impedance and to convert from impedance to admittance and vice versa. This chart is very useful for measurements using the TYPE 1601-A V-H-F Bridge, TYPE 1602-B U-H-F Admittance Meter, and the TYPE 874-LBA Slotted Line.

Smith charts are usually drawn with normalized impedance coordinates, so that they can be used with lines of any impedance. For work at a single characteristic impedance, a chart reading directly in impedance or admittance is more convenient, because it

eliminates the normalizing operation. Four forms of the Smith chart are available, one with normalized coordinates, one with normalized expanded coordinates, one with impedance coordinates (50-ohm characteristic impedance), and one with admittance coordinates (20-millimho characteristic admittance). The 50-ohm characteristic impedance (20-millimho characteristic admittance) is common to all General Radio coaxial equipment. Charts are printed on thin 8½" x 11" paper.

Several copies of the appropriate chart are furnished with the TYPE 874-LBA Slotted Line, the TYPE 874-UB Balun, the TYPE 1601-A V-H-F Bridge, and the TYPE 1602-B U-H-F Admittance Meter. Additional charts or charts for other applications can be obtained from General Radio Company at the following prices:

Quantity	Price	Quantity	Price
50 ²	\$2.00	500	\$14.00
100	3.75	1000	25.00
200	7.00	2000	47.00

Be sure to specify type of chart wanted.

¹ Electronics, Vol. 17, No. 1, pp. 150-153, 318-325, January 1944.

² Minimum quantity sold.

Type	Code Word	Price
Smith Chart—Admittance Coordinates (20-millimho Characteristic Admittance)	ADMITCHART	See Above
Smith Chart—Impedance Coordinates (50-ohm Characteristic Impedance)	IMPEDCHART	See Above
Smith Chart—Normalized Coordinates	NORMACHART	See Above
Smith Chart—Normalized Expanded Coordinates	EXPANCHART	See Above





DECIBEL CONVERSION TABLES

It is convenient in measurements and calculations on communications systems to express the ratio between any two amounts of electric or acoustic power in units on a logarithmic scale. The *decibel* (1/10th of the *bel*) on the briggsian or base-10 scale and the *neper* on the napierian or base- e scale are in almost universal use for this purpose.

Since voltage and current are related to power by impedance, both the *decibel* and the *neper* can be used to express voltage and current ratios, if care is taken to account for the

impedances associated with them. In a similar manner the corresponding acoustical quantities can be compared.

Table I and Table II on the following pages have been prepared to facilitate making conversions in either direction between the number of *decibels* and the corresponding power, voltage, and current ratios. Both tables can also be used for *nepers* and the *mile of standard cable* by applying the conversion factors from the table on the opposite page.

Decibel—The number of decibels N_{db} corresponding to the ratio between two amounts of power P_1 and P_2 is

$$N_{db} = 10 \log_{10} \frac{P_1}{P_2} \quad (1)$$

When two voltages E_1 and E_2 or two currents I_1 and I_2 operate in identical impedances,

$$N_{db} = 20 \log_{10} \frac{E_1}{E_2} \quad (2)$$

$$\text{and} \quad N_{db} = 20 \log_{10} \frac{I_1}{I_2} \quad (3)$$

If E_1 and E_2 or I_1 and I_2 operate in unequal impedances,

$$N_{db} = 20 \log_{10} \frac{E_1}{E_2} + 10 \log_{10} \frac{Z_2}{Z_1} + 10 \log_{10} \frac{k_1}{k_2} \quad (4)$$

$$\text{and} \quad N_{db} = 20 \log_{10} \frac{I_1}{I_2} + 10 \log_{10} \frac{Z_1}{Z_2} + 10 \log_{10} \frac{k_1}{k_2} \quad (5)$$

where Z_1 and Z_2 are the absolute magnitudes of the corresponding impedances and k_1 and k_2 are the values of power factor for the impedances. $E_1, E_2, I_1,$ and I_2 are also the absolute magnitudes of the corresponding quantities. Note that Table I and Table II can be

used to evaluate the impedance and power factor terms, since both are similar to the expression for power ratio, equation (1).

Neper—The number of nepers N_{nep} corresponding to a power ratio $\frac{P_1}{P_2}$ is

$$N_{nep} = \frac{1}{2} \log_e \frac{P_1}{P_2} \quad (6)$$

For voltage ratios $\frac{E_1}{E_2}$ or current ratios $\frac{I_1}{I_2}$ working in identical impedances,

$$N_{nep} = \log_e \frac{E_1}{E_2} \quad (7)$$

$$\text{and} \quad N_{nep} = \log_e \frac{I_1}{I_2}$$

When E_1 and E_2 or I_1 and I_2 operate in unequal impedances,

$$N_{nep} = \log_e \frac{E_1}{E_2} + \frac{1}{2} \log_e \frac{Z_2}{Z_1} + \frac{1}{2} \log_e \frac{k_1}{k_2} \quad (8)$$

and

$$N_{nep} = \log_e \frac{I_1}{I_2} + \frac{1}{2} \log_e \frac{Z_1}{Z_2} + \frac{1}{2} \log_e \frac{k_1}{k_2} \quad (9)$$

where Z_1 and Z_2 and k_1 and k_2 are as in equations (4) and (5).





RELATIONS BETWEEN DECIBELS, NEPERS, AND MILES OF STANDARD CABLE

<i>Multiply</i>	<i>By</i>	<i>To Find</i>
decibels1151	nepers
decibels	1.056	miles of standard cable
miles of standard cable	.947	decibels
miles of standard cable	.109	nepers
nepers	8.686	decibels
nepers	9.175	miles of standard cable

TO FIND VALUES OUTSIDE THE RANGE OF CONVERSION TABLES

Values outside the range of either Table I or Table II on the following pages can be

readily found with the help of the following simple rules:

TABLE I: DECIBELS TO VOLTAGE AND POWER RATIOS

Number of decibels positive (+): Subtract +20 decibels successively from the given number of decibels until the remainder falls within range of Table I. *To find the voltage ratio*, multiply the corresponding value from the right-hand voltage-ratio column by 10 for each time you subtracted 20 db. *To find the power ratio*, multiply the corresponding value from the right-hand power-ratio column by 100 for each time you subtracted 20 db.

Example—Given: 49.2 db.

$$49.2 \text{ db} - 20 \text{ db} - 20 \text{ db} = 9.2 \text{ db}$$

$$\text{Voltage ratio: } 9.2 \text{ db} \rightarrow 2.884$$

$$2.884 \times 10 \times 10 = 288.4 \rightarrow 49.2 \text{ db}$$

$$\text{Power ratio: } 9.2 \text{ db} \rightarrow 8.318$$

$$8.318 \times 100 \times 100 = 83180 \rightarrow 49.2 \text{ db}$$

Number of decibels negative (-): Add +20 decibels successively to the given number of decibels until the sum falls within the range of Table I. *For the voltage ratio*, divide the value from the left-hand voltage-ratio column by 10 for each time you added 20 db. *For the power ratio*, divide the value from the left-hand power-ratio column by 100 for each time you added 20 db.

Example—Given: -49.2 db

$$-49.2 \text{ db} + 20 \text{ db} + 20 \text{ db} = -9.2 \text{ db}$$

$$\text{Voltage ratio: } -9.2 \text{ db} \rightarrow .3467$$

$$.3467 \times 1/10 \times 1/10 = .003467 \rightarrow -49.2 \text{ db}$$

$$\text{Power ratio: } -9.2 \text{ db} \rightarrow .1202$$

$$.1202 \times 1/100 \times 1/100 = .00001202 \rightarrow -49.2 \text{ db}$$

TABLE II: VOLTAGE RATIOS TO DECIBELS

For ratios smaller than those in table—Multiply the given ratio by 10 successively until the product can be found in the table. From the number of decibels thus found, subtract +20 decibels for each time you multiplied by 10.

Example—Given: Voltage ratio = .0131

$$.0131 \times 10 \times 10 = 1.31$$

$$\text{From Table II, } 1.31 \rightarrow 2.345 \text{ db}$$

$$2.345 \text{ db} - 20 \text{ db} - 20 \text{ db} = -37.655 \text{ db}$$

For ratios greater than those in table—Divide the given ratio by 10 successively until the remainder can be found in the table. To the number of decibels thus found, add +20 db for each time you divided by 10.

Example—Given: Voltage ratio = 712

$$712 \times 1/10 \times 1/10 = 7.12$$

$$\text{From Table II, } 7.12 \rightarrow 17.050 \text{ db}$$

$$17.050 \text{ db} + 20 \text{ db} + 20 \text{ db} = 57.050 \text{ db}$$





TABLE I

GIVEN: Decibels

TO FIND: Power and $\left\{ \begin{matrix} \text{Voltage} \\ \text{Current} \end{matrix} \right\}$ Ratios

TO ACCOUNT FOR THE SIGN OF THE DECIBEL

For positive (+) values of the decibel—Both voltage and power ratios are greater than unity. Use the two right-hand columns.

For negative (-) values of the decibel—Both voltage and power ratios are less than unity. Use the two left-hand columns.

Example—Given: ± 9.1 db Find:

	Power Ratio	Voltage Ratio
+9.1 db	8.128	2.851
-9.1 db	0.1230	0.3508

← -db+ →

Voltage Ratio	Power Ratio	db	Voltage Ratio	Power Ratio
1.0000	1.0000	0	1.000	1.000
.9886	.9772	.1	1.012	1.023
.9772	.9550	.2	1.023	1.047
.9661	.9333	.3	1.035	1.072
.9550	.9120	.4	1.047	1.096
.9441	.8913	.5	1.059	1.122
.9333	.8710	.6	1.072	1.148
.9226	.8511	.7	1.084	1.175
.9120	.8318	.8	1.096	1.202
.9016	.8128	.9	1.109	1.230
.8913	.7943	1.0	1.122	1.259
.8810	.7762	1.1	1.135	1.288
.8710	.7586	1.2	1.148	1.318
.8610	.7413	1.3	1.161	1.349
.8511	.7244	1.4	1.175	1.380
.8414	.7079	1.5	1.189	1.413
.8318	.6918	1.6	1.202	1.445
.8222	.6761	1.7	1.216	1.479
.8128	.6607	1.8	1.230	1.514
.8035	.6457	1.9	1.245	1.549
.7943	.6310	2.0	1.259	1.585
.7852	.6166	2.1	1.274	1.622
.7762	.6026	2.2	1.288	1.660
.7674	.5888	2.3	1.303	1.698
.7586	.5754	2.4	1.318	1.738
.7499	.5623	2.5	1.334	1.778
.7413	.5495	2.6	1.349	1.820
.7328	.5370	2.7	1.365	1.862
.7244	.5248	2.8	1.380	1.905
.7161	.5129	2.9	1.396	1.950
.7079	.5012	3.0	1.413	1.995
.6998	.4898	3.1	1.429	2.042
.6918	.4786	3.2	1.445	2.089
.6839	.4677	3.3	1.462	2.138
.6761	.4571	3.4	1.479	2.188
.6683	.4467	3.5	1.496	2.239
.6607	.4365	3.6	1.514	2.291
.6531	.4266	3.7	1.531	2.344
.6457	.4169	3.8	1.549	2.399
.6383	.4074	3.9	1.567	2.455
.6310	.3981	4.0	1.585	2.512
.6237	.3890	4.1	1.603	2.570
.6166	.3802	4.2	1.622	2.630
.6095	.3715	4.3	1.641	2.692
.6026	.3631	4.4	1.660	2.754
.5957	.3548	4.5	1.679	2.818
.5888	.3467	4.6	1.698	2.884
.5821	.3388	4.7	1.718	2.951
.5754	.3311	4.8	1.738	3.020
.5689	.3236	4.9	1.758	3.090

← -db+ →

Voltage Ratio	Power Ratio	db	Voltage Ratio	Power Ratio
.5623	.3162	5.0	1.778	3.162
.5559	.3090	5.1	1.799	3.236
.5495	.3020	5.2	1.820	3.311
.5433	.2951	5.3	1.841	3.388
.5370	.2884	5.4	1.862	3.467
.5309	.2818	5.5	1.884	3.548
.5248	.2754	5.6	1.905	3.631
.5188	.2692	5.7	1.928	3.715
.5129	.2630	5.8	1.950	3.802
.5070	.2570	5.9	1.972	3.890
.5012	.2512	6.0	1.995	3.981
.4955	.2455	6.1	2.018	4.074
.4898	.2399	6.2	2.042	4.169
.4842	.2344	6.3	2.065	4.266
.4786	.2291	6.4	2.089	4.365
.4732	.2239	6.5	2.113	4.467
.4677	.2188	6.6	2.138	4.571
.4624	.2138	6.7	2.163	4.677
.4571	.2089	6.8	2.188	4.786
.4519	.2042	6.9	2.213	4.898
.4467	.1995	7.0	2.239	5.012
.4416	.1950	7.1	2.265	5.129
.4365	.1905	7.2	2.291	5.248
.4315	.1862	7.3	2.317	5.370
.4266	.1820	7.4	2.344	5.495
.4217	.1778	7.5	2.371	5.623
.4169	.1738	7.6	2.399	5.754
.4121	.1698	7.7	2.427	5.888
.4074	.1660	7.8	2.455	6.026
.4027	.1622	7.9	2.483	6.166
.3981	.1585	8.0	2.512	6.310
.3936	.1549	8.1	2.541	6.457
.3890	.1514	8.2	2.570	6.607
.3846	.1479	8.3	2.600	6.761
.3802	.1445	8.4	2.630	6.918
.3758	.1413	8.5	2.661	7.079
.3715	.1380	8.6	2.692	7.244
.3673	.1349	8.7	2.723	7.413
.3631	.1318	8.8	2.754	7.586
.3589	.1288	8.9	2.786	7.762
.3548	.1259	9.0	2.818	7.943
.3508	.1230	9.1	2.851	8.128
.3467	.1202	9.2	2.884	8.318
.3428	.1175	9.3	2.917	8.511
.3388	.1148	9.4	2.951	8.710
.3350	.1122	9.5	2.985	8.913
.3311	.1096	9.6	3.020	9.120
.3273	.1072	9.7	3.055	9.333
.3236	.1047	9.8	3.090	9.550
.3199	.1023	9.9	3.126	9.772





TABLE II

GIVEN: $\left\{ \begin{array}{l} \text{Voltage} \\ \text{Current} \end{array} \right\}$ Ratio

TO FIND: Decibels

POWER RATIOS

To find the number of decibels corresponding to a given power ratio—Assume the given power ratio to be a voltage ratio and find the corresponding number of decibels from the table. The desired result is exactly one-half of the number of decibels thus found.

Example—Given: a power ratio of 3.41.

Find: 3.41 in the table:

3.41 → 10.655 db (voltage)

10.655 db × $\frac{1}{2}$ = 5.328 db (power)

Voltage Ratio	.00	.01	.02	.03	.04	.05	.06	.07	.08	.09
1.0	.000	.086	.172	.257	.341	.424	.506	.588	.668	.749
1.1	.828	.906	.984	1.062	1.138	1.214	1.289	1.364	1.438	1.511
1.2	1.584	1.656	1.727	1.798	1.868	1.938	2.007	2.076	2.144	2.212
1.3	2.279	2.345	2.411	2.477	2.542	2.607	2.671	2.734	2.798	2.860
1.4	2.923	2.984	3.046	3.107	3.167	3.227	3.287	3.346	3.405	3.464
1.5	3.522	3.580	3.637	3.694	3.750	3.807	3.862	3.918	3.973	4.028
1.6	4.082	4.137	4.190	4.244	4.297	4.350	4.402	4.454	4.506	4.558
1.7	4.609	4.660	4.711	4.761	4.811	4.861	4.910	4.959	5.008	5.057
1.8	5.105	5.154	5.201	5.249	5.296	5.343	5.390	5.437	5.483	5.529
1.9	5.575	5.621	5.666	5.711	5.756	5.801	5.845	5.889	5.933	5.977
2.0	6.021	6.064	6.107	6.150	6.193	6.235	6.277	6.319	6.361	6.403
2.1	6.444	6.486	6.527	6.568	6.608	6.649	6.689	6.729	6.769	6.809
2.2	6.848	6.888	6.927	6.966	7.008	7.044	7.082	7.121	7.159	7.197
2.3	7.235	7.272	7.310	7.347	7.384	7.421	7.458	7.495	7.532	7.568
2.4	7.604	7.640	7.676	7.712	7.748	7.783	7.819	7.854	7.889	7.924
2.5	7.959	7.993	8.028	8.062	8.097	8.131	8.165	8.199	8.232	8.266
2.6	8.299	8.333	8.366	8.399	8.432	8.465	8.498	8.530	8.563	8.595
2.7	8.627	8.659	8.691	8.723	8.755	8.787	8.818	8.850	8.881	8.912
2.8	8.943	8.974	9.005	9.036	9.066	9.097	9.127	9.158	9.188	9.218
2.9	9.248	9.278	9.308	9.337	9.367	9.396	9.426	9.455	9.484	9.513
3.0	9.542	9.571	9.600	9.629	9.657	9.686	9.714	9.743	9.771	9.799
3.1	9.827	9.855	9.883	9.911	9.939	9.966	9.994	10.021	10.049	10.076
3.2	10.103	10.130	10.157	10.184	10.211	10.238	10.264	10.291	10.317	10.344
3.3	10.370	10.397	10.423	10.449	10.475	10.501	10.527	10.553	10.578	10.604
3.4	10.630	10.655	10.681	10.706	10.731	10.756	10.782	10.807	10.832	10.857
3.5	10.881	10.906	10.931	10.955	10.980	11.005	11.029	11.053	11.078	11.102
3.6	11.126	11.150	11.174	11.198	11.222	11.246	11.270	11.293	11.317	11.341
3.7	11.364	11.387	11.411	11.434	11.457	11.481	11.504	11.527	11.550	11.573
3.8	11.596	11.618	11.641	11.664	11.687	11.709	11.732	11.754	11.777	11.799
3.9	11.821	11.844	11.866	11.888	11.910	11.932	11.954	11.976	11.998	12.019
4.0	12.041	12.063	12.085	12.106	12.128	12.149	12.171	12.192	12.213	12.234
4.1	12.256	12.277	12.298	12.319	12.340	12.361	12.382	12.403	12.424	12.444
4.2	12.465	12.486	12.506	12.527	12.547	12.568	12.588	12.609	12.629	12.649
4.3	12.669	12.690	12.710	12.730	12.750	12.770	12.790	12.810	12.829	12.849
4.4	12.869	12.889	12.908	12.928	12.948	12.967	12.987	13.006	13.026	13.045
4.5	13.064	13.084	13.103	13.122	13.141	13.160	13.179	13.198	13.217	13.236
4.6	13.255	13.274	13.293	13.312	13.330	13.349	13.368	13.386	13.405	13.423
4.7	13.442	13.460	13.479	13.497	13.516	13.534	13.552	13.570	13.589	13.607
4.8	13.625	13.643	13.661	13.679	13.697	13.715	13.733	13.751	13.768	13.786
4.9	13.804	13.822	13.839	13.857	13.875	13.892	13.910	13.927	13.945	13.962
5.0	13.979	13.997	14.014	14.031	14.049	14.066	14.083	14.100	14.117	14.134
5.1	14.151	14.168	14.185	14.202	14.219	14.236	14.253	14.270	14.287	14.303
5.2	14.320	14.337	14.353	14.370	14.387	14.403	14.420	14.436	14.453	14.469
5.3	14.486	14.502	14.518	14.535	14.551	14.567	14.583	14.599	14.616	14.632
5.4	14.648	14.664	14.680	14.696	14.712	14.728	14.744	14.760	14.776	14.791
5.5	14.807	14.823	14.839	14.855	14.870	14.886	14.902	14.917	14.933	14.948
5.6	14.964	14.979	14.995	15.010	15.026	15.041	15.056	15.072	15.087	15.102
5.7	15.117	15.133	15.148	15.163	15.178	15.193	15.208	15.224	15.239	15.254
5.8	15.269	15.284	15.298	15.313	15.328	15.343	15.358	15.373	15.388	15.402
5.9	15.417	15.432	15.446	15.461	15.476	15.490	15.505	15.519	15.534	15.549





TABLE II (continued)

Voltage Ratio	.00	.01	.02	.03	.04	.05	.06	.07	.08	.09
6.0	15.563	15.577	15.592	15.606	15.621	15.635	15.649	15.664	15.678	15.692
6.1	15.707	15.721	15.735	15.749	15.763	15.778	15.792	15.806	15.820	15.834
6.2	15.848	15.862	15.876	15.890	15.904	15.918	15.931	15.945	15.959	15.973
6.3	15.987	16.001	16.014	16.028	16.042	16.055	16.069	16.083	16.096	16.110
6.4	16.124	16.137	16.151	16.164	16.178	16.191	16.205	16.218	16.232	16.245
6.5	16.258	16.272	16.285	16.298	16.312	16.325	16.338	16.351	16.365	16.378
6.6	16.391	16.404	16.417	16.430	16.443	16.456	16.469	16.483	16.496	16.509
6.7	16.521	16.534	16.547	16.560	16.573	16.586	16.599	16.612	16.625	16.637
6.8	16.650	16.663	16.676	16.688	16.701	16.714	16.726	16.739	16.752	16.764
6.9	16.777	16.790	16.802	16.815	16.827	16.840	16.852	16.865	16.877	16.890
7.0	16.902	16.914	16.927	16.939	16.951	16.964	16.976	16.988	17.001	17.013
7.1	17.025	17.037	17.050	17.062	17.074	17.086	17.098	17.110	17.122	17.135
7.2	17.147	17.159	17.171	17.183	17.195	17.207	17.219	17.231	17.243	17.255
7.3	17.266	17.278	17.290	17.302	17.314	17.326	17.338	17.349	17.361	17.373
7.4	17.385	17.396	17.408	17.420	17.431	17.443	17.455	17.466	17.478	17.490
7.5	17.501	17.513	17.524	17.536	17.547	17.559	17.570	17.582	17.593	17.605
7.6	17.616	17.628	17.639	17.650	17.662	17.673	17.685	17.696	17.707	17.719
7.7	17.730	17.741	17.752	17.764	17.775	17.786	17.797	17.808	17.820	17.831
7.8	17.842	17.853	17.864	17.875	17.886	17.897	17.908	17.919	17.931	17.942
7.9	17.953	17.964	17.975	17.985	17.996	18.007	18.018	18.029	18.040	18.051
8.0	18.062	18.073	18.083	18.094	18.105	18.116	18.127	18.137	18.148	18.159
8.1	18.170	18.180	18.191	18.202	18.212	18.223	18.234	18.244	18.255	18.266
8.2	18.276	18.287	18.297	18.308	18.319	18.329	18.340	18.350	18.361	18.371
8.3	18.382	18.392	18.402	18.413	18.423	18.434	18.444	18.455	18.465	18.475
8.4	18.486	18.496	18.506	18.517	18.527	18.537	18.547	18.558	18.568	18.578
8.5	18.588	18.599	18.609	18.619	18.629	18.639	18.649	18.660	18.670	18.680
8.6	18.690	18.700	18.710	18.720	18.730	18.740	18.750	18.760	18.770	18.780
8.7	18.790	18.800	18.810	18.820	18.830	18.840	18.850	18.860	18.870	18.880
8.8	18.890	18.900	18.909	18.919	18.929	18.939	18.949	18.958	18.968	18.978
8.9	18.988	18.998	19.007	19.017	19.027	19.036	19.046	19.056	19.066	19.075
9.0	19.085	19.094	19.104	19.114	19.123	19.133	19.143	19.152	19.162	19.171
9.1	19.181	19.190	19.200	19.209	19.219	19.228	19.238	19.247	19.257	19.266
9.2	19.276	19.285	19.295	19.304	19.313	19.323	19.332	19.342	19.351	19.360
9.3	19.370	19.379	19.388	19.398	19.407	19.416	19.426	19.435	19.444	19.453
9.4	19.463	19.472	19.481	19.490	19.499	19.509	19.518	19.527	19.536	19.545
9.5	19.554	19.564	19.573	19.582	19.591	19.600	19.609	19.618	19.627	19.636
9.6	19.645	19.654	19.664	19.673	19.682	19.691	19.700	19.709	19.718	19.726
9.7	19.735	19.744	19.753	19.762	19.771	19.780	19.789	19.798	19.807	19.816
9.8	19.825	19.833	19.842	19.851	19.860	19.869	19.878	19.886	19.895	19.904
9.9	19.913	19.921	19.930	19.939	19.948	19.956	19.965	19.974	19.983	19.991

Voltage Ratio	0	1	2	3	4	5	6	7	8	9
10	20.000	20.828	21.584	22.279	22.923	23.522	24.082	24.609	25.105	25.575
20	26.021	26.444	26.848	27.235	27.604	27.959	28.299	28.627	28.943	29.248
30	29.542	29.827	30.103	30.370	30.630	30.881	31.126	31.364	31.596	31.821
40	32.041	32.256	32.465	32.669	32.869	33.064	33.255	33.442	33.625	33.804
50	33.979	34.151	34.320	34.486	34.648	34.807	34.964	35.117	35.269	35.417
60	35.563	35.707	35.848	35.987	36.124	36.258	36.391	36.521	36.650	36.777
70	36.902	37.025	37.147	37.266	37.385	37.501	37.616	37.730	37.842	37.953
80	38.062	38.170	38.276	38.382	38.486	38.588	38.690	38.790	38.890	38.988
90	39.085	39.181	39.276	39.370	39.463	39.554	39.645	39.735	39.825	39.913
100	40.000	—	—	—	—	—	—	—	—	—

To find ratios outside the range of this table, see page 244



INDEX BY TYPE NUMBER

<i>Type</i>	<i>Name</i>	<i>Page</i>	<i>Type</i>	<i>Name</i>	<i>Page</i>
CAP-15	3-Wire Power Cord	237	648-P1	Replacement Lamp	198
CAP-35	2-Wire Power Cord	237	667-A	Inductance Bridge	23
DNT	Detectors	64	716-C	Capacitance Bridge	10
KN	Knobs	234	716-CS1	Capacitance Bridge	12
M2	Variac® Autotransformers	214, 215	716-P4	Guard Circuit	13
M5	Variac® Autotransformers	214, 215	720-A	Heterodyne Frequency Meter	87
M10	Variac® Autotransformers	214, 215	722	Precision Capacitors	164
M20	Variac® Autotransformers	214, 215	723-C,-D	Vacuum-Tube Forks	107
VB, VBT	Replacement Brushes See appropriate Variac Type Number.		736-A	Wave Analyzer	223
W2	Variac® Autotransformers	207	740-B	Capacitance Test Bridge . .	17
W5	Variac® Autotransformers	208	759-P22	100-foot Cable	186
W10	Variac® Autotransformers	209	759-P25	Dynamic Microphone Assembly	186
W20	Variac® Autotransformers	210	759-P35	Vibration Pickup	188
W50	Variac® Autotransformers	211	759-P36	Control Box	188
50-P1, P2	Chokes	205, 211	760-B	Sound Analyzer	193
W5MT3A	Metered Variac®	215	761-A	Vibration Meter	194
W5MT3W	Metered Variac®	215	761-P1	Replacement Pickup	195
107	Variable Inductors	178	762-B	Vibration Analyzer	193
109-A	Three-Wire Receptacle . . .	237	783-A	Output Power Meter	134
219-M	Decade Condenser	171	805-C	Standard Signal Generator	94
274	Plugs and Jacks	236	838-B	Alligator Clip	239
274	Patch Cords	237	874	Coaxial Elements See index on	41
314-S86	Variable Delay Line	124	874-LBA	Slotted Line and Vernier . .	43
480-P	Panels	202	874-LM	Dielectric Measuring Line	46
500	Resistors	161	874-MD	Slotted-Line Motor Drive	45
505	Capacitors	168	901	Dials	233
510	Decade Resistance Units . .	157	902	Dials	233
544-B	Megohm Bridge	8	904	Dials	233
544-P3	AC Power Supply Unit . . .	9	907	Dials	232
544-P10	Battery Power Supply Unit	9	907-R	Dial Drives	152
546-C	AF Microvolter	133	908	Dials	232
578	Shielded Transformers . . .	235	908-P1, P2	Synchronous Dial Drives . .	151
583-A	Output Power Meter	134	908-R	Dial Drives	152
631-BL	Strobotac	197	916-AL	Radio-Frequency Bridge . .	32
631-P1	Strobotron	197	938	Binding Posts and Jacks . .	238
648-A	Strobolux	198	940	Decade Inductors	179
			941-A	Toroidal Transformer . . .	235
			970-P	Potentiometer Dial Plates	233



INDEX BY TYPE NUMBER

<i>Type</i>	<i>Name</i>	<i>Page</i>	<i>Type</i>	<i>Name</i>	<i>Page</i>
971-978	Potentiometers	229	1209-B, BL	Unit Oscillators	113
980	Decade Capacitor Units	172	1210-C	Unit RC Oscillator	110
1000-P3	Voltage Divider	96	1211-B	Unit Oscillator	113
1000-P4	Dummy Antenna	96	1212-A	Unit Null Detector	63
1000-P5	Transformer	96	1212-P1, P2	Filters	64
1000-P6	Crystal Diode Modulator	97	1213-C	Unit Time/Frequency Calibrator	86
1000-P7	Balanced Modulator	98	1214-A, D	Unit Oscillators	112
1000-P10	Test Loop	96	1214-E, M	Unit Oscillators	112
1001-A	Standard-Signal Generator	92	1215-B	Unit Oscillator	113
1021-AU, AV	Standard-Signal Generators	90	1216-A	Unit I-F Amplifier	66
1021-P1	Power Supply Unit and Cabinet	91	1217-A	Unit Pulser	122
1021-P2, P3B	Oscillator Units	91	1218-A	Unit Oscillator	113
1021-P10	Storage Box for Oscillator	91	1219-A	Unit Pulse Amplifier	123
1100-APV	Frequency Standards	73	1220-A	Unit Klystron Oscillator	116
1100-AQV	Frequency Standards	73	1230-A, AE	DC Amplifier and Electrometer	130
1105-A	Frequency Measurement Equipment	76	1230-P1	Component Shield	131
1106-A, B, C	Frequency Transfer Units	79	1231-B	Amplifier and Null Detector	61
1107-A	Interpolation Oscillator	81	1231-P	Filters and Attenuators	62
1108-A	Coupling Panel	82	1233-A	Power Amplifier	67
1109-A	Comparison Oscilloscope	83	1261-A	Power Supply	145
1112-A, B	Standard-Frequency Multipliers	84	1262-B	Power Supply	145
1116-A	Emergency Power Supply	75	1263-A	Amplitude-Regulating Power Supply	144
1181-B	Frequency Deviation Monitor	138	1301-A	Low-Distortion Oscillator	101
1181-BH	Frequency Deviation Monitor	139	1301-P1	Range Extension Unit	101
1181-BT	Color Subcarrier Monitor	139	1302-A	Oscillator	106
1184-A-A	TV-Transmitter Monitor	136	1304-B	Beat-Frequency Audio Generator	104
1201-B	Unit Regulated Power Supply	143	1305-A	Low-Frequency Oscillator	102
1203-B	Unit Power Supply	143	1307-A	Transistor Oscillator	107
1204-B	Unit Variable Power Supply	143	1330-A	Bridge Oscillator	108
1205-B	Adjustable Regulated Power Supply	142	1390-A	Random Noise Generator	125
1206-B	Unit Amplifier	68	1390-P1	Voltage Divider	126
1208-B	Unit Oscillator	113	1391-B	Pulse, Sweep, and Time- Delay Generator	118
			1392-A	Time-Delay Generator	120
			1401	Fixed Air Capacitors (2 Terminal)	167
			1403	Fixed Air Capacitors (3 Terminal)	167



INDEX BY TYPE NUMBER

<i>Type</i>	<i>Name</i>	<i>Page</i>	<i>Type</i>	<i>Name</i>	<i>Page</i>
1409	Standard Capacitors	169	1601-A	VHF Bridge	33
1419-A, K	Polystyrene Decade Capacitors	170	1602-B	UHF Admittance Meter	34
1420	Variable Air Capacitors	228	1603-A	Z-Y Bridge	28
1421	Variable Air Capacitors	228	1605-A	Impedance Comparator	26
1429-A	Fuel-Gage Tester	174	1606-A	RF Bridge	30
1432	Decade Resistors	155	1606-P1	Luggage-type Carrying Case	31
1450	Decade Attenuators	159	1607-A	Transfer-Function and Immittance Bridge	36
1454-A, AH	Decade Voltage Dividers	160	1607-P101	Transistor Mount	37
1481	Standard Inductors	177	1607-P102	Transistor Mount	37
1482	Standard Inductors	176	1607-P201	Tube Mount	38
1490	Decade Inductors	179	1610-A	Capacitance Measuring Assembly	14
1521-A	Graphic-Level Recorder	147	1610-AH	Capacitance Measuring Assembly	15
1521-P	Recorder Accessories	148	1611-B	Capacitance Test Bridge	18
1532-B	Strobolume	199	1613-A	Capacitance Bridge	20
1532-P1	Replacement Lamp	199	1632-A	Inductance Bridge	22
1532-P2	Transformer Cable	199	1650-A	Impedance Bridge	24
1535-B	Contacting	200	1650-P1	Test Jig	24
1535-P1	Adaptor Cable	200	1652-A	Resistance Limit Bridge	6
1550-A	Octave-Band Noise Analyzer	190	1661-A	Vacuum-Tube Bridge	39
1550-P1	Adaptor Microphone Plug	190	1690-A	Dielectric Sample Holder	16
1551-B	Sound-Level Meter	184	1690-P2	Adaptor Assembly	16
1551-P1	Condenser Microphone Systems	187	1691-A	Capacitance Test Jig	13
1551-P2	Leather Carrying Case	185	1700	Variac® Speed Controls	220
1552-B	Sound-Level Calibrator	189	1701	Variac® Speed Controls	220
1554-A	Sound and Vibration Analyzer	192	1702	Variac® Speed Controls	220
1555-A	Sound-Survey Meter	183	1702-P3	Switch	221
1555-P2	Leather Carrying Case	183	1703	Variac® Speed Controls	220
1556-A	Impact Noise Analyzer	191	1705-P1	Drum Controller	221
1560-P31	Leather Carrying Case	189	1750-A	Sweep Drive	149
1560-P34	Tripod and Extension Cable	188	1800-B	Vacuum-Tube Voltmeter	128
1560-P91	Adaptor	186	1800-P	Multipliers	129
1560-P94	Adaptor	186	1862-B	Megohmmeter	132
1570-A	Automatic Voltage Regulator	216	1931-B	Modulation Monitor	140
1570-AS15	Militarized Voltage Regulator	218	1932-A	Distortion and Noise Meter	225
1570-AS25	Militarized 3-Phase Voltage Regulator	218	1932-P1	A-M Detector Unit	226
			1951-A, E	Filters	64



INDEX BY TITLE

	<i>Page</i>		<i>Page</i>
AC Power Supplies	142-145	UHF	34, 36
Adaptor Plug, Microphone	190	Universal	24, 28
Adaptors, Coaxial (See index on page 41.)	58, 237	VHF	33, 34, 36
Adaptor Panels, Relay Rack, for Unit Instruments	202	Vacuum Tube	36, 39
Adaptors, Sound-Level Meter	186	Z-Y	28
Adjustable Attenuator	63	Bridge Amplifier	61
Adjustable Attenuator, Coaxial	54	Bridge Detectors	61, 63, 64
Adjustable Autotransformer, Variac®	203-215	Bridge Guard Circuit	13
Adjustable Lines and Stubs, Coaxial	51, 53	Bridge Transformer	235
Adjustable Power Supply	142, 143	Broad-Band Modulator	97, 98
Admittance Meter, UHF	34	Broadcast Monitors, Frequency and Modulation	135-141
Admittance Bridge, AF	28		
Air Capacitors, Fixed, Two-Terminal	167	Cable, Coaxial	56
Fixed, Three-Terminal	167	Cable, Tripod and Extension	188
Precision, Two-Terminal	164-166	Cable Connectors, Coaxial	57
Precision, Three-Terminal	164-166	Calibrator for Fuel Gage Testers	20
Standard	164-167	Calibrator (Tester), Fuel Gage	174
Variable	53, 164-167, 228	Calibrator, Sound-Level	189
Air Line, Coaxial	51	Calibrator, Time/Frequency	86
Alligator Clip	239	Capacitance Bridges	10, 12, 14, 15, 17, 18 20, 24, 30, 32, 33
A-M Detector	50, 226	Capacitors	162-174, 228
Amplifier, Audio-Frequency	61, 62, 67, 68	Capacitors, Air Dielectric	53, 164-167, 228
Direct Current	130	Decade	170-173
Intermediate Frequency	66	Fixed	167-169
Power	67	Mica Dielectric	168, 169, 171-173
Pulse	123	Paper Dielectric	171-173
Amplifier and Null Detector	61	Polystyrene Dielectric	170, 172
Amplitude Modulators	97, 98	Precision	164-166
Amplitude-Regulating Power Supply	144	Standard	164-166, 167, 169
Analyzers, Continuous Spectrum	192, 193, 223	Three-Terminal	164-173
Impact Noise	191	Two-Terminal	164-167, 169-173
Noise	190-193	Variable Air	53, 164-166, 228
Octave-Band	190	Capacitor Test Fixture	13
One-Third Octave	192	Case for RF Bridge	31
Sound	190, 192, 193	for Sound-Level Meter	185
Vibration	192, 193	for Sound-Survey Meter	183
Wave	223	for Transistor Oscillator and Calibrator	189
Antenna, Dummy	96	Chokes (for Variacs)	205, 211
Antenna Measuring Equipment	30, 32, 33, 34, 36, 43	Cliplock, Coaxial	55
Attenuator, Adjustable	62	Coaxial Elements	51-58
Coaxial	54	Coaxial Instruments	34, 36, 43, 45, 46
Decade	159	Coaxial Patchcords	56
Audio-Frequency Microvoltage	133	Color-Subcarrier Frequency Monitor	139
Audio-Frequency Oscillators	81, 101-113	Comparator, Impedance	26
Audio Generator, Beat-Frequency	104	Comparison Bridges	6, 26
Automatic Dial Drives	149-152	Comparison Oscilloscope	83
Automatic Voltage Regulators	216-218	Component Mounts	55, 130
Autotransformers, Variac®	203-215	Condenser Microphone Systems	187
		Connectors, Coaxial	57
Balanced Modulator	98	Shielded	236
Balun	48	Contact, Stroboscopic	200
Bar Knobs	234	Control Box and Vibration Pickup	188
Basic Connector, Coaxial	57	Controls, Motor Speed	219-221
Basic Motor Speed Controls	219-221	Cords, Patch	56, 237
Beat-Frequency Oscillators	81, 104	Cords, Power	237
Binding Posts	238	Coupling Elements, Coaxial	53
Bridges, AC Limit	26	Coupling Panel	82
Admittance	28, 34, 36	Crystal Diode Modulators	97, 98
Antenna Measuring	30, 32, 33, 34		
Capacitance	10, 12, 14, 15, 17, 18 20, 28, 30, 32, 33	Decade Attenuator	159
Coaxial	34, 36	Decade Capacitors	170-173
DC Limit	6	Decade Inductors	179
High-Resistance	8	Decade Resistors	155-158
Immittance	36	Decade Switches	158, 173
Impedance	26, 28, 30, 32, 33, 34, 36	Decade Voltage Divider	160
Impedance Comparison	26	Delay Generators, Time	118, 120
Inductance	22, 24, 30, 33, 34, 36	Delay-Line, Variable	124
Insulation Resistance	8	Detector, Voltmeter	50
Megohm	8	Detectors	50, 60-66, 226
Radio-Frequency	12, 15, 30, 32, 33, 34, 36	Detectors, Null	60-66, 222
Resistance	6, 8	Deviation Monitor, Frequency	138
Resistivity	8	Dial, Direct-Drive and Friction-Drive	233
Transfer-Function	36	Gear-Drive, Precision	232
Transistor	36, 39	Dial Drives, Automatic Sweep	149-152



INDEX BY TITLE

	<i>Page</i>
Dial Drives, Synchronous	151
with Horizontal Sweep	152
Dielectric Measuring Bridge	10, 12, 14
Dielectric Measuring Line	46
Dielectric Sample Holder	16
Diode Modulators, Crystal	97, 98
Direct-Current Amplifier	130
Distortion and Noise Meter	225
Drive, Dial	149-152
Drive, Sweep	149
Drum Controller	219
Dummy Antenna	96
Dynamic Microphone Assembly	186
Electrometer	130
Filters, Coaxial	49
High-Pass	64
Low-Pass	49
Rejection	49
Tuned Circuit	62, 64
Fork, Vacuum-Tube Driven	107
Frequency-Deviation Monitor	138
Frequency Measuring Equipment	76
Frequency Meters, Heterodyne	79, 88
Frequency Monitors	136, 138
Frequency Multipliers	84
Frequency Standards	73, 86
Friction-Drive Dial	233
Fuel-Gage Tester	174
Gear-Drive Dial	232
Generators	
Pulse	117-123
Random-Noise	125
Sine-Wave	89-116
Square-Wave	110, 118, 122
Standard Frequency	73
Standard-Signal	89-95
Three-Phase	102
Time-Delay	120
Graphic Level Recorder	147
Guard Circuit	13
Harmonic Analyzers	192, 193, 223
Heterodyne Frequency Meters	79, 87
High-Level Microphone	187
High-Pass Filter	64
High-Speed Light Source	197, 198, 199
Immittance Bridge	30
Impact Noise Analyzer	191
Impedance Bridges	24, 28
Impedance-Matching Transformer	235
Inductance Bridge	22
Inductors, Decade	179
Fixed	176, 177
Standard	176, 177, 178
Variable	178
Insulated Plugs	236
Insulators, Panel Terminal	239
Intermediate-Frequency Amplifier, Unit	65
Interpolation Equipment	76
Interpolation Oscillator	81
Jacks and Plugs	236
Kit, Slotted Line	47
Kits, Cable Measuring	47
Klystron Oscillator	116
Knobs	234
Limit Bridge, Resistance	6
Limit Bridges	6, 26
Line, Dielectric Measuring	46
Line, Slotted	43

	<i>Page</i>
Line, Variable Delay	124
Lines and Line Elements, Coaxial	51
Loop, Test	96
Low-Distortion Oscillator	101
Low-Frequency Oscillator	102
Low-Pass Filter	49
Matched Terminations, Coaxial	52
Mechanical Sweep Drives	149-152
Megohm Bridge	8
Megohmmeters	130, 132
Mega-megohmmeter	130
Meters, Distortion and Noise	225
Frequency Deviation	138
Heterodyne Frequency	79, 88
Megohm	130, 132
Noise	183, 184
Output	134
Sound-Level	184
Sound-Survey	183
UHF Admittance	34
Vacuum-Tube Voltmeter	128
Vibration	194
Micro-microammeter	130
Microphone Adaptor Plug	190
Microphone Assembly, Dynamic	186
Microphone System, Condenser	187
Microvolter	133
Militarized Voltage Regulator	218
Militarized 3-Phase Voltage Regulator	218
Mixer-Rectifier	40
Modulation Monitor	149
Modulator, Video	97
Modulators, Amplitude	97, 98
Balanced	97
Crystal Diode	97, 98
Pulse	98
Monitors, Frequency	136-139
Monitors, Modulation	136-141
Motor Drive, Slotted Line	145
Motor Drives, Dial	149-152
Motor Drive, Sweep	149
Motor Speed Controls	219-221
Multiplier (For Vacuum-Tube Voltmeter)	129
Multipliers, Standard-Frequency	84
Multivibrators	74
Mutual Inductance Standard	178
Noise Analyzers, Impulse	191
Octave-Band	190
One-Third Octave	192
Noise Generator, Random	125
Noise Meters	183, 184
Null Detector and Amplifier	61
Null Detector, Unit	63
Null-Detector, UHF-VHF	64
Octave-Band Noise Analyzer	190
Oscillators, Audio	81, 101-107
Beat-Frequency	81, 104
Electro-Mechanical	107
Four-Phase	102
Interpolation	81
Inverse Feedback	101, 106
Klystron	116
Low-Frequency	102
Piezo-Electric	74, 86
Radio-Frequency	79, 108, 113-116
Resistance-Capacitance Tuned	101, 106, 110
Sweep Drive	149
Super-High Frequency	116
Three-Phase	102
Transistor	107
Tuning-Fork-Driven	107
Ultra-High-Frequency	113-116



INDEX BY TITLE

	<i>Page</i>		<i>Page</i>
Unit	112-116, 122, 123	Strobotac®	197
Variable Phase	102	Stubs, Coaxial	53
Very-High-Frequency	113-115	Sweep Drive, Automatic	149
Oscilloscope, Comparison	83	Sweep Drive, Slotted Line	45
Output-Power Meter	134	Sweep Drives	45, 149-152
Pads, Attenuator	54	Sweep Generator, Pulse, Time-Delay	118
Panel Terminal Insulator	239	Synchrometer	74
Parts and Accessories	227-239	Synchronous Dial Drives	151
Patch Cords	56, 237	Television Transmitter Monitor	136
Pickup, Vibration	188	Terminations, Coaxial	52
Piezo-Electric Oscillators	74-86	Test Fixture, Capacitor	13
Plugs and Jacks	236	Test Loop	96
Polyethylene Cable	56	Tester, Fuel Gage	174
Polystyrene Capacitors	170, 172	Three-Phase Line Voltage Regulator	218
Potentiometers	229	Three-Terminal Capacitors	164-167, 169-173
Power Amplifier	67	Time-Delay Generators	118, 120
Power Cords	237	Time-Delay, Pulse and Sweep Generator	118
Power Meters, Output	134	Time/Frequency Calibrator, Unit	86
Power Supplies	142-145	Transfer-Function Bridge	36
Power Supply, Amplitude Regulating	144	Transformers, Adjustable (Variac®)	203-215
Power Supplies, Unit	142-143	Bridge	235
Precision Capacitor	164	Impedance Matching	235
Precision Dials	232	Shielded	235
Primary Frequency Standard	73	Toroidal	235
Pulse Amplifier, Unit	123	VHF	96
Pulse Generators	118, 120, 122	Transistor Bridges	36, 39
Pulse, Sweep and Time-Delay Generator	118	Transistor Mounts	37
Pulser, Unit	122	Transistor Oscillator	107
Radio-Frequency Bridge	30, 32, 33	Tripod and Extension Cable	188
Radio-Frequency Oscillator	108, 113-116	Tube Mounts	38
Random Noise Generator	125	Tuned-Circuit Filters	62, 64
RC Oscillators	101, 106, 110	Tuning Fork Oscillator	107
Recorder, Graphic Level	147	Two-Terminal Capacitors	164-173
Recorder Accessories	148	UHF Coaxial Equipment	41-58
Rectifier, Mixer	49	UHF Heterodyne Frequency Meter	88
Rectifier, Voltmeter	50	UHF Oscillator	113-116
Regulated Power Supplies, Unit	142, 143	UHF Standard-Signal Generator	90
Regulating Power Supply, Amplitude	144	Unit Instruments	201-202
Regulators, Line Voltage	216	Universal Bridge	28
Militarized	218	Vacuum-Tube Bridge	36, 39
Militarized 3-Phase	218	Vacuum-Tube Voltmeter	128
Rejection Filters, Coaxial	49	Variable Air Capacitor	53, 164-166, 228
Resistance Bridges	6, 8	Variable Delay Line	124
Resistance Meters, Megohm	130, 132	Variable Inductor	178
Resistors, Decade	155-158	Variable Power Supplies	142, 143
Fixed	161	Variable Resistor	229-231
Variable	229-231	Variac® Autotransformers	203-215
Rheostat and Voltage Divider	229-231	Variac Motor Speed Controls	219-221
Rigid-Line Adaptors, Coaxial	58	Variac Voltage Regulators	216-218
Sample Holder, Dielectric	16	Variometer	178
Secondary Frequency Standard	73	VHF Coaxial Equipment	41-58
Shielded Transformer	235	VHF Oscillators	113-115
Signal Generators, Standard	89-98	VHF Standard-Signal Generator	90
Slotted Line	43	Vibration Analyzers	192-193
Slotted Line, Dielectric Measuring	46	Vibration Meter	194
Slotted-Line Motor Drive	45	Vibration Pickup	188
Smith Charts	242	Voltage Dividers	96, 126, 160, 229
Sound Analyzers	192, 193	Voltage Divider (10:1)	96
Sound-Level Calibrator	189	Voltage Dividers (Decade)	126, 160
Sound-Level Meter	184	Voltage Divider (Rheostat)	229
Sound-Survey Meter	183	Voltage Regulator, Automatic	216
Speed Controls, Motor	219-221	Militarized	218
Square-Wave Generators	110, 118, 122	Militarized 3-Phase	218
Standards, Capacitance	164-166, 167, 169	Voltmeter, Vacuum-Tube	128
Inductance	176-178	Voltmeter Detector	50
Mutual Inductance	178	Voltmeter Indicator	50
Primary Frequency	73	Voltmeter Rectifier	50
Secondary Frequency	73	Wave Analyzers	192, 193, 223
Standard-Frequency Multipliers	84	Waveform-Measuring Instruments	222-226
Strobolume	199	Z-Y Bridge	28
Strobolux®	198		
Stroboscopes	196-200		



EXPORT REPRESENTATIVES

AUSTRALIA

HAYWARD C. PARISH
Box 2148 G.P.O.
Sydney, Australia
WARBURTON, FRANKI, LIMITED
380 Bourke Street
Melbourne, Australia

BELGIUM

Technische Verkoopkantoor GROENPOL
Post Office Box 1188
Amsterdam, Holland

CANADA

(See inside front cover)

DENMARK

MOGENS BANG & COMPANY, INC.
19, Vangehusvej
Copenhagen O, Denmark

EGYPT

MOUSTAPHA EZZAT ABDEL WAHAB & COMPANY
106, Mohamed Bey Farid Street
Post Office Box 1537
Cairo, Egypt

FINLAND

K. L. NYMAN
11 Meritullinkatu
Helsinki, Finland

FRANCE

ETS. RADIOPHON
50, Rue du Faubourg Poissonniere
Paris 10, France
RADIOPHON CORPORATION
509 Madison Ave.
New York 22, New York

GERMANY

DR.-ING. GÜNTER NÜSSLEIN
Dörnigweg 6
Ettlingen/Karlsruhe, W. Germany

GREECE

K. KARAYANNIS
Karitsi Square
Athens, Greece

INDIA

MOTWANE PRIVATE LIMITED
127 Mahatma Gandhi Road
P. O. Box 1312, Fort
Bombay 1, India

ISRAEL

LANDSEAS EASTERN COMPANY
P. O. Box 2554
Tel Aviv, Israel
LANDSEAS PRODUCTS CORPORATION
48 West Forty-Eighth St.
New York 36, New York

ITALY

ING. S. & DR. GUIDO BELOTTI
Piazza Trento, 8
Milan, Italy

JAPAN

MIDORIYA ELECTRIC COMPANY, LTD.
3, 2-chome, Kyobashi
Chuo-ku
Tokyo, Japan

LATIN AMERICA

AD. AURIEMA, INC.
85 Broad Street
New York 4, New York
Resident offices in principal cities of South
America, Central America, Mexico, and the
Caribbean area.

NETHERLANDS

Technische Verkoopkantoor GROENPOL
Post Office Box 1188
Amsterdam, Holland

NEW ZEALAND

HAYWARD C. PARISH
Box 2148 G.P.O.
Sydney, Australia
SPEDDING, LIMITED
Cor. Beach Road & Anzac Avenue
Auckland, C.1, New Zealand

NORWAY

MASKIN-AKTIESELSKAPET ZETA
Drammensveien 26
Oslo 22, Norway

SOUTH AFRICA

G. H. LANGLER & COMPANY, LTD.
249 Main Street
Johannesburg, South Africa

SPAIN and PORTUGAL

AD. AURIEMA, INC.
85 Broad Street
New York 4, New York
Resident offices in Madrid and Lisbon.

SWEDEN

JOHN C. LAGERCRANTZ
Vartavagen 57
Stockholm, Sweden

SWITZERLAND

SEYFFER AND COMPANY, INC.
Badenerstrasse 265
Zurich, Switzerland

TURKEY

ETABLISSEMENT MEHMET VASFI
Boite Postale 143
Istanbul, Turkey

UNITED KINGDOM

CLAUDE LYONS, LIMITED
Valley Works
4-10 Ware Road
Hoddesdon, Herts, England
CLAUDE LYONS, LIMITED
76 Old Hall Street
Liverpool, England

GENERAL RADIO COMPANY



AMPLIFIERS — SEE DETECTORS

x **BRIDGES** AND OTHER IMPEDANCE-MEASURING INSTRUMENTS

CAPACITORS — SEE REACTANCE

40 **COAXIAL** ELEMENTS, SLOTTED LINES, CONNECTORS, ADAPTORS

58 **DETECTORS AND AMPLIFIERS**

DISTORTION METERS — SEE WAVE ANALYZERS

68 **FREQUENCY** STANDARDS AND METERS

88 STANDARD-SIGNAL

98 OSCILLATORS

GENERATORS

116 PULSE AND NOISE

INDUCTORS — SEE REACTANCE

126 **METERS** VTVM, POWER, MEGOHM, ELECTROMETER

134 **MONITORS** MODULATION AND FREQUENCY FOR RADIO AND TV STATIONS

142 **POWER SUPPLIES**

146 **RECORDERS AND DIAL DRIVES**

152 **RESISTANCE** DECADES, ATTENUATORS, VOLTAGE DIVIDERS

162 **REACTANCE** CAPACITORS, INDUCTORS, STANDARDS, DECADES

180 **SOUND AND VIBRATION** METERS AND ANALYZERS

196 **STROBOSCOPES**

SWEEP DRIVES — SEE RECORDERS

200 **UNIT INSTRUMENTS**

UHF-VHF INSTRUMENTS — SEE COAXIAL

202 ADJUSTABLE AUTOTRANSFORMERS

216 AUTOMATIC VOLTAGE REGULATORS

VARIAC®

218 MOTOR SPEED CONTROLS

222 **WAVE ANALYZERS**

226 **PARTS AND ACCESSORIES**

240 **CHARTS AND TABLES**

248 **INDEX** BY TITLE — BY TYPE NUMBER

CATALOG P
GENERAL RADIO COMPANY
West Concord, Massachusetts
 U. S. A.

DISTRICT OFFICES: NEW YORK • CHICAGO • LOS ANGELES
 PHILADELPHIA • SAN FRANCISCO • WASHINGTON, D. C.
 TORONTO
 (See inside front cover)

REPRESENTATIVES IN PRINCIPAL COUNTRIES
 (See inside back cover)