

1863 and 1864 Megohmmeters Instruction Manual

Form 1863-0100-00/A2

©QuadTech, Inc., 1993
5 Clock Tower Place, 210 East
Maynard, Massachusetts, U.S.A. 01754
November, 2001

Telephone 978-461-2100
Sales 800-253-1230
Facsimile 978-461-4295
Website www.quadtech.com

The material in this manual is for informational purposes only and is subject to change, without notice. QuadTech assumes no responsibility for any error or for consequential damages that may result from the misinterpretation of any procedures in this publication.

Contents

Warranty
Instruction Manual Changes
Condensed Operating Instructions
Specifications
Introduction - Section 1
Installation - Section 2
Operation - Section 3
Applications - Section 4
Theory - Section 5
Service and Maintenance - Section 6
Parts Lists and Diagrams - Section 7

WARNING

Potentially dangerous voltages may be present on panel terminals. Follow all warnings in this manual when operating or servicing this instrument. Dangerous energy levels may be stored in capacitors tested by the meter. Always set the FUNCTION switch to DISCHARGE before connecting or disconnecting the unknown components. Refer all servicing to qualified personnel.

Symbol  IEC417 on equipment signifies that the manual contains information to prevent injury or equipment damage

Warranty



QuadTech warrants that Products are free from defects in material and workmanship and, when properly used, will perform in accordance with QuadTech's applicable published specifications. If within one (1) year after original shipment it is found not to meet this standard, it will be repaired, or at the option of QuadTech, replaced at no charge when returned to a QuadTech service facility.

Changes in the Product not approved by QuadTech shall void this warranty.

QuadTech shall not be liable for any indirect, special or consequential damages, even if notice has been given of the possibility of such damages.

This warranty is in lieu of all other warranties, expressed or implied, including, but not limited to any implied warranty or merchantability or fitness for a particular purpose.

SERVICE POLICY

QuadTech policy is to maintain product repair capability for a period of five (5) years after original shipment and to make this capability available at the then prevailing schedule of charges.

HANDLING PRECAUTIONS FOR ELECTRONIC DEVICES SUBJECT TO DAMAGE BY STATIC ELECTRICITY

Place instrument or system component to be serviced, spare parts in conductive (anti-static) envelopes or carriers, hand tools, etc. on a work surface defined as follows. The work surface, typically a bench top, must be conductive and reliably connected to earth ground through a safety resistance of approximately 250 kilohms to 500 kilohms. Also, for personnel safety, the surface must NOT be metal. (A resistivity of 30 to 300 kilohms per square is suggested.) Avoid placing tools or electrical parts on insulators, such as books, paper, rubber pads, plastic bags, or trays.

Ground the frame of any line-powered equipment, test instruments, lamps, drills, soldering irons, etc., directly to earth ground. Accordingly, (to avoid shorting out the safety resistance) be sure that grounded equipment has rubber feet or other means of insulation from the work surface. The instrument or system component being serviced should be similarly insulated while grounded through the power-cord ground wire, but must be connected to the work surface before, during, and after any disassembly or other procedure in which the line cord is disconnected.

Exclude any hand tools and other items that can generate a static charge. (examples of forbidden items are non-conductive plunger-type solder suckers and rolls of tape.)

Ground yourself reliably, through a resistance, to the work surface; use, for example, a conductive strap or cable with a wrist cuff. The cuff must make electrical contact directly with your skin; do NOT wear it over clothing. (Resistance between skin contact and work surface through a commercially available personnel grounding device is typically in the range of 250 kilohms to 1 megohm.)

If any circuit boards or IC packages are to be stored or transported, enclose them in conductive envelopes and/or carriers. Remove the items from such envelopes only with the above precautions; handle IC packages without touching the contact pins.

Avoid circumstances that are likely to produce static charges, such as wearing clothes of synthetic material, sitting on a plastic-covered or rubber-footed stool (particularly while wearing wool), combing your hair, or making extensive erasures. These circumstances are most significant when the air is dry.

When testing static-sensitive devices, be sure dc power is on before, during, and after application of test signals. Be sure all pertinent voltages have been switched off while boards or components are removed or inserted, whether hard-wired or plug-in.

Instruction Manual Changes

This supplementary page contains information, improvements, or modifications not documented in other sections of the manual. Any references to GenRad in the manual now apply to QuadTech, Inc.

Page 7-3 – Electrical Parts List (Regulator & Amplifier PC Board)

- C108 is corrected to read:
CAP CER DISC .01 μ F 20% 100V 4400-6534
- C202 is corrected to read:
CAP CER DISC .01 μ F 20% 100V 4400-6534

Page 7-9 – Parts Lists And Diagrams (Figure 7-9, 1864 Schematic Diagram)

- Q204 labeling for Source (S) and Gate (G) is reversed.

Condensed Operating Instructions

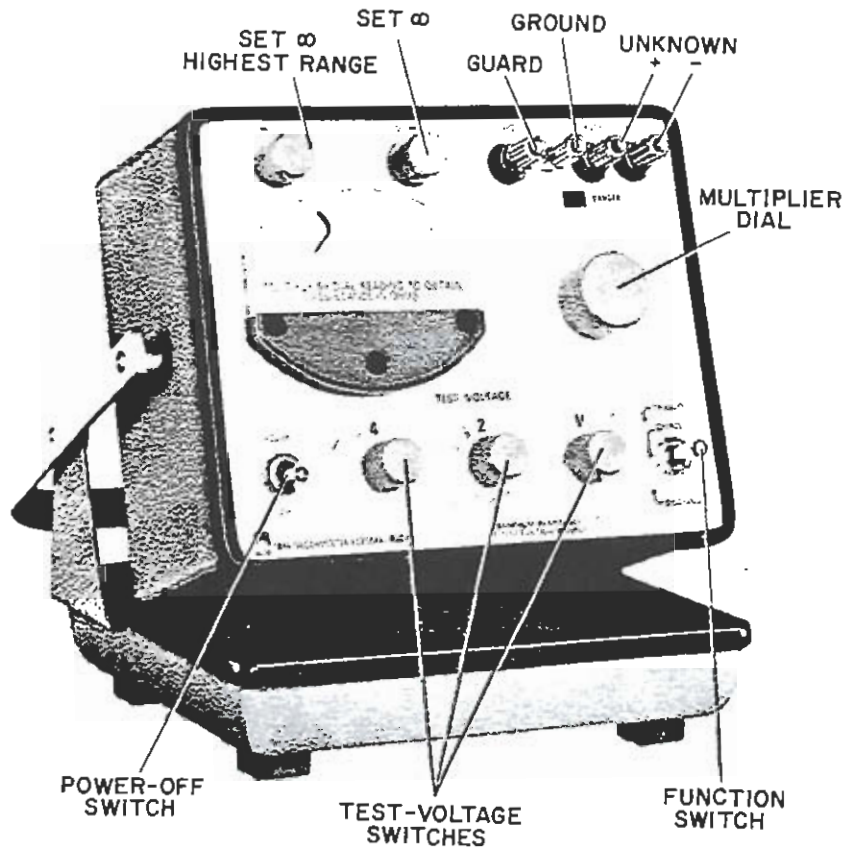

Figure 1-1. Type 1864 front-panel view.

NOTE

The 1863 front panel is similar. See Figure 1-2.

- a. Determine which ground link connection is to be used (paragraph 3.1.1).
- b. Set the TEST VOLTAGE switch(es) to the proper voltage (paragraph 3.1.2).
- c. Set the ∞ adjustments (paragraph 3.1.3).
- d. Connect the unknown to the UNKNOWN terminals.
- e. Measure the unknown with either the search (paragraph 3.2.2) or sort (paragraph 3.2.3) procedure.

Specifications

Voltage and Resistance Ranges:

Voltage	R _{max} Full Scale	R _{min} †		Useful Ranges
		10% of Scale	2½% of Scale	
50, 100 V 200, 250, 500 V	50 kΩ	Type 1863 500 GΩ	2 TΩ	7
	500 kΩ	5 TΩ	20 TΩ	7
10 to 50 V 50 to 100 V 100 to 500 V 500 to 1000 V	50 kΩ	Type 1864 500 GΩ	2 TΩ*	7*
	200 kΩ	5 TΩ	20 TΩ	8
	500 kΩ	5 TΩ	20 TΩ*	7*
	5 MΩ	50 TΩ	200 TΩ	8

† Note: Meter deflects to the left, so 2½% is near the right; however, the meter scale reads naturally, from left to right.

* Recommended limit.

Resistance Accuracy: ±2(meter reading + 1)% on lowest 5 ranges (min reading is 0.5). For 6th, 7th, 8th ranges, respectively, add ±2%, ±4%, ±, for the 1863; ±2%, ±3%, ±5%, for the 1864.

Voltage Accuracy (across unknown): ±2%.

Short-Circuit Current: 5 mA approx.

Power: 100 to 125 or 200 to 250 V, 50 to 400 Hz, 13 W.

Supplied: Mounting hardware with rack models.

Mechanical: Flip-Tilt case and rack mount. **DIMENSIONS** (wxhxd): Portable, 6.63x10x6.75 in. (245x254x172 mm); rack, 19x7x4.63 in. (483x178x118 mm). **WEIGHT:** Portable, 9.5 lb (4.4 kg) net, 14 lb (7 kg) shipping; rack 11 lb (5 kg) net.

Description	Catalog Number
1863 Megohmmeter	
Portable Model	1863-9700
Rack Model	1863-9701
1864 Megohmmeter	
Portable Model	1864-9700
Rack Model	1864-9701

Introduction—Section 1

1.1 DESCRIPTION	1-1
1.2 OPENING AND TILTING THE CABINET	1-1
1.3 CONTROLS, CONNECTORS AND INDICATORS	1-1
1.4 ACCESSORIES SUPPLIED	1-1
1.5 ACCESSORIES AVAILABLE	1-1
1.6 SYMBOLS	1-5
1.7 CONNECTIONS	1-5

WARNING

High voltage is applied to the measurement terminals of the Types 1863 and 1864 Megohmmeters, except when the function switch is set to DISCHARGE. While the current from the instrument is limited to a value that is not dangerous under most conditions, the energy stored in a capacitor connected to the terminals may be lethal. Always set the function switch to DISCHARGE when you connect or disconnect the unknown.

1.1 DESCRIPTION.

The Type 1863 Megohmmeter indicates directly on the panel meter any resistance from 0.5 to 20,000,000 M Ω ; the Type 1864 (Figure 1-1) indicates resistance from 0.5 to 200,000,000 M Ω . These ranges are suitable for leakage-resistance measurements of most types of insulation used in electrical machinery, electronic devices and components, etc (Section 4). The voltage applied to the unknown can be 50, 100, 200, 250 or 500 V from the 1863, as selected by the TEST VOLTAGE switch on the front panel. The 1864 has a voltage range from 10 to 1090 V that can be set in 1-V steps from 10 to 109 V, and 10-V steps from 100 to 1090 V by the TEST VOLTAGE switch on the front panel.

The 100-volt level is the EIA standard for measurement of composition, film, and wire-wound resistors above 100 kilohms. The 500-volt level is a standard value in the measurement of the insulation resistance of rotating machinery, transformers, cables, capacitors, appliances, and other electrical equipment.

Regulated power supply and charging circuit permit rapid and accurate measurement of the leakage resistance of capacitors.

Guard and ground terminals permit measurement of grounded or ungrounded two- or three-terminal resistors.

A panel warning light indicates when voltage is applied to the test terminals and thus permits connections to be made safely.

1.2 OPENING AND TILTING THE CABINET.

The Flip-Tilt cabinet can be opened by placing the instrument on its rubber feet with the handle away from you. Push down on the handle and the instrument, located in the upper part of the case, will rotate to a vertical position. While holding the handle down with one hand, rotate the instrument to the desired position with the other hand and release the handle.

1.3 CONTROLS, CONNECTORS AND INDICATORS.

Figure 1-2 shows the front-panel controls, connectors and indicators of the 1863 and 1864. Table 1-1 lists and identifies them. Figure 1-3 shows the rear panel controls and connectors and Table 1-2 lists and identifies them.

1.4 ACCESSORIES SUPPLIED.

The accessories supplied with the 1863 and 1864 Megohmmeters are listed in Table 1-3.

1.5 ACCESSORIES AVAILABLE.

Table 1-4 lists a group of GR patch cords available for use with the megohmmeters. The GR 1591 Variac® Automatic Voltage Regulator can be used with the megohmmeters (paragraph 4.3.5 part 3). Consult the latest GR Catalog for a complete selection of accessories.

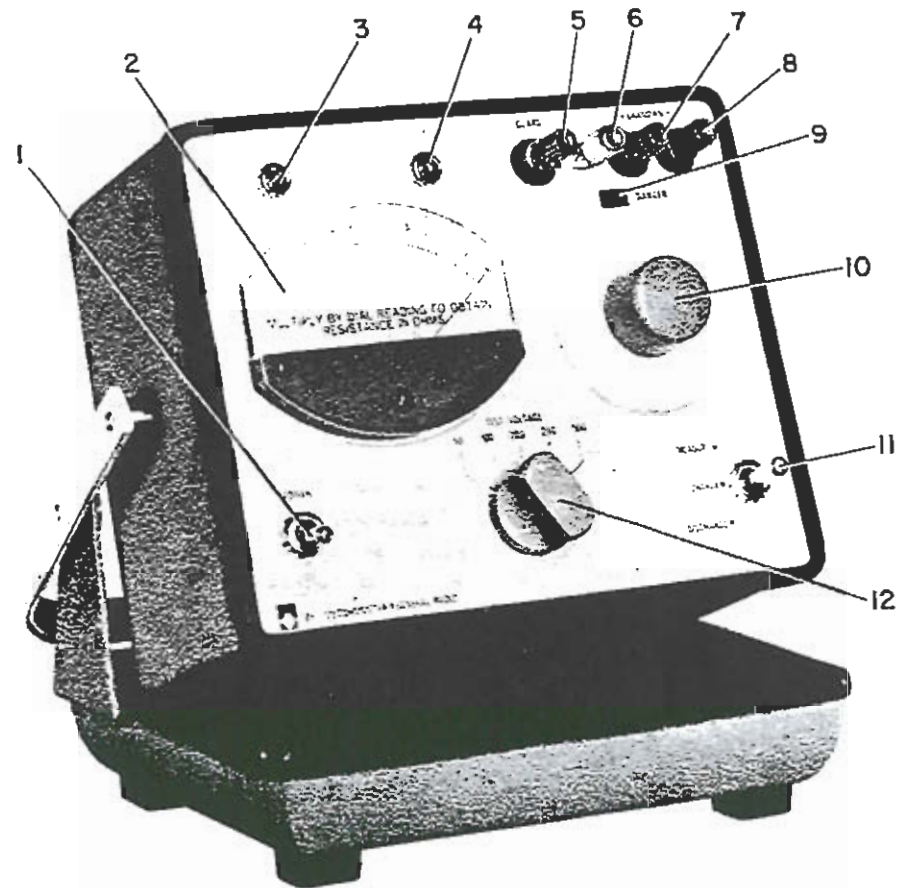

Figure 1-2. Type 1863 front-panel controls, connectors and indicators.

NOTE
 The 1864 front panel is similar. See Figure 1-1.

Table 1-1
FRONT-PANEL CONTROLS, CONNECTORS AND INDICATORS

Figure 1-2 Reference	Name	Instrument		Type	Function
		1863	1864		
1	POWER OFF	X	X	2-position toggle switch	Turns power on and off.
2	Meter	X	X	4-in. meter with plastic cover	Indicates the value to be multiplied by the multiplier switch.
3	SET ∞ HIGHEST RANGE	X		Screwdriver rotated control	Adjusts high end of meter scale on highest resistance range to compensate for offset current.
			X	Knob rotated control	
4	SET ∞	X		Screwdriver rotated control	Adjusts high end of meter scale to compensate for offset voltage in the voltmeter.
			X	Knob rotated control	
5	GUARD	X	X	Insulated binding post	For guarded measurements. The center of the post is 3/4 in. from the center of the ground post so that it can accept a shorting link.
6	Ground	X	X	Uninsulated binding post	Grounds the + unknown or guard. Contains captive shorting link.
7	UNKNOWN +	X	X	Insulated binding post	Connects the + side of the unknown to the megohmmeter.
8	UNKNOWN -	X	X	Insulated binding post	Connects the - side of the unknown to the megohmmeter.
9	DANGER	X	X	Indicating light shaded red	Glows red when the function switch is in the CHARGE or MEASURE position.
10	Multiplier	X		7-position rotary switch	Selects resistance range.
			X	8-position rotary switch	
11	MEASURE- CHARGE- DISCHARGE	X	X	3-position toggle switch	Selects the operating mode applied to the unknown.
12	TEST VOLTAGE	X		5-position rotary switch	Selects the test voltage as 50, 100, 200, 250 or 500 V.
			X	3 rotary switches: a 10- position, a 9-position and a 2-position (left to right)	Select voltage in 1-V steps from 10 to 109 V and in 10-V steps from 100 to 1090 V.

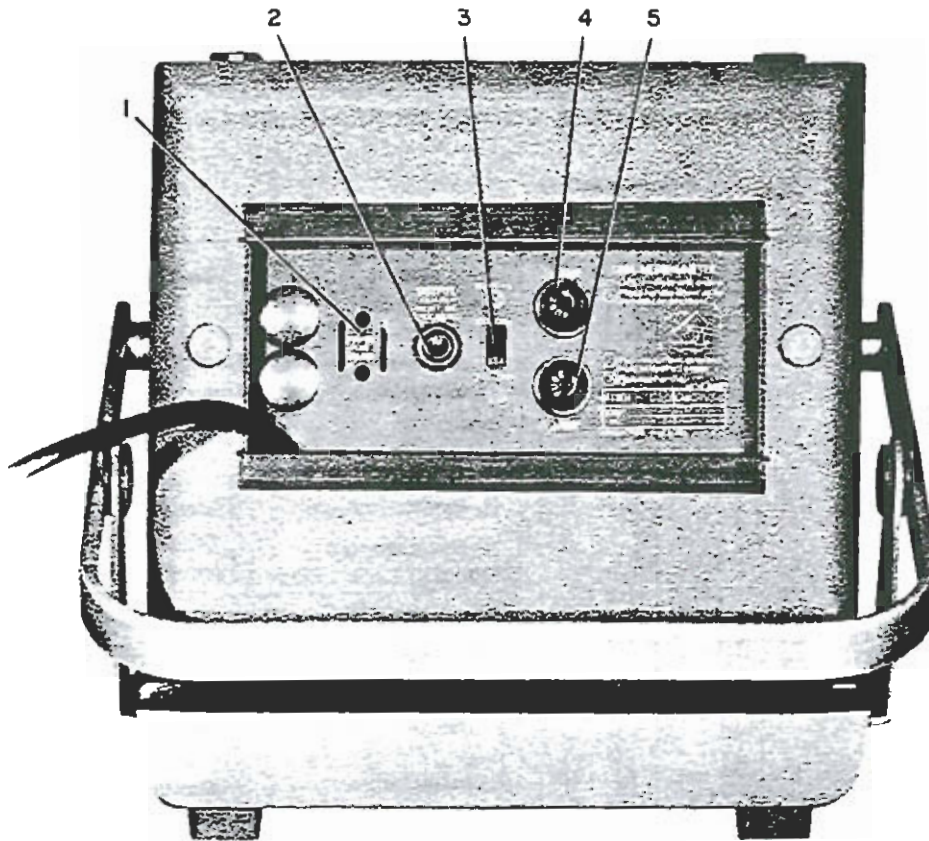

Figure 1-3. Type 1864 rear-panel controls and connectors.

Table 1-2
REAR-PANEL CONTROLS AND CONNECTORS

Figure 1-3 Reference	Name	Instrument		Type	Function
		1863	1864		
1	POWER PLUG HOLDER	X	X	Holes cut in rear panel	Holds power plug in place after power cord has been wrapped inside cover.
2	OUTPUT	X	X	Phone jack (Accepts Switchcraft No. 440 phone plug)	Provides a dc voltage output for recorder operation.
3	Line-voltage	X	X	2-position slide switch	Connects wiring of power transformer for either 100- to 125-V or 200- to 230-V input.
4	1/8 AMP	X	X	Extractor-type fuse holder	Holder for 1/8-A fuse for 100- to 125-V operation.
5	1/16 AMP	X	X	Extractor-type fuse holder	Holder for 1/16-A fuse for 200- to 230-V operation.

Table 1-3
ACCESSORIES SUPPLIED*

Item	GR Part Number	Quantity
Instruction Manual	1863-0100	1

*Supplied with either an 1863 or 1864 or Megohmmeter, portable or rack-mount instrument.

1.6 SYMBOLS.

These instruments indicate the resistance of the unknown in multiples of ohms. The relationship between ohms (Ω), kilohms ($k\Omega$), megohms ($M\Omega$), gigohms ($G\Omega$), and terahms ($T\Omega$) is as follows:

$$1 M\Omega = 10^6 \Omega = 10^3 k\Omega$$

$$1 G\Omega = 10^9 \Omega = 10^6 k\Omega = 10^3 M\Omega$$

$$1 T\Omega = 10^{12} \Omega = 10^9 k\Omega = 10^6 M\Omega = 10^3 G\Omega$$

1.7 CONNECTIONS.

The UNKNOWN, GUARD and ground terminals are standard 3/4-in. spaced binding posts that accept banana

plugs, standard telephone tips, alligator clips, crocodile clips, spade terminals and all wire sizes up to number eleven (Figure 1-4).

When several measurements of components with leads are to be made, the GR 1650-P1 Test Jig (Figure 1-5) can be used.

WARNING

The terminals of the test jig are not insulated. The presence of a high test voltage can be dangerous.

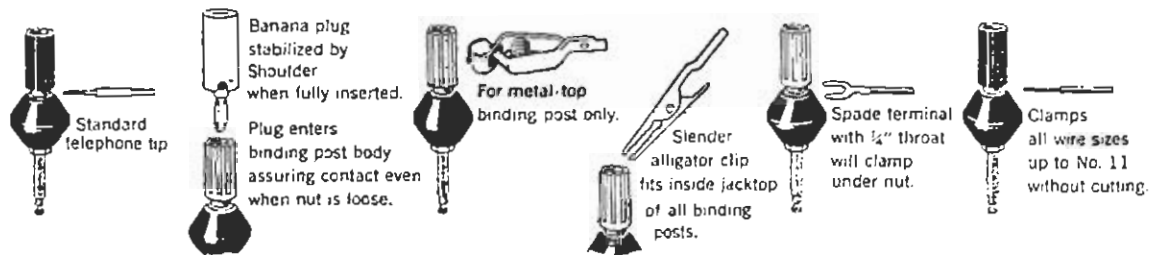

Figure 1-4. Methods of connection to the measurement terminals.

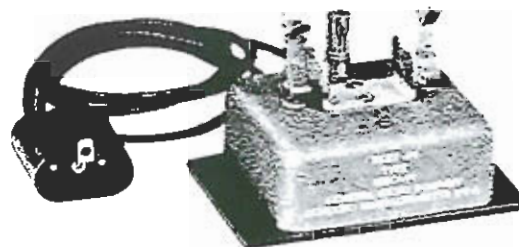

Figure 1-5. Type 1650-P1 Test Jig.

Installation—Section 2

2.1 DIMENSIONS	2-1
2.2 BENCH MOUNTING	2-1
2.3 POWER CONNECTIONS	2-1
2.4 RACK MOUNTING	2-1
2.5 LINE-VOLTAGE REGULATION	2-3

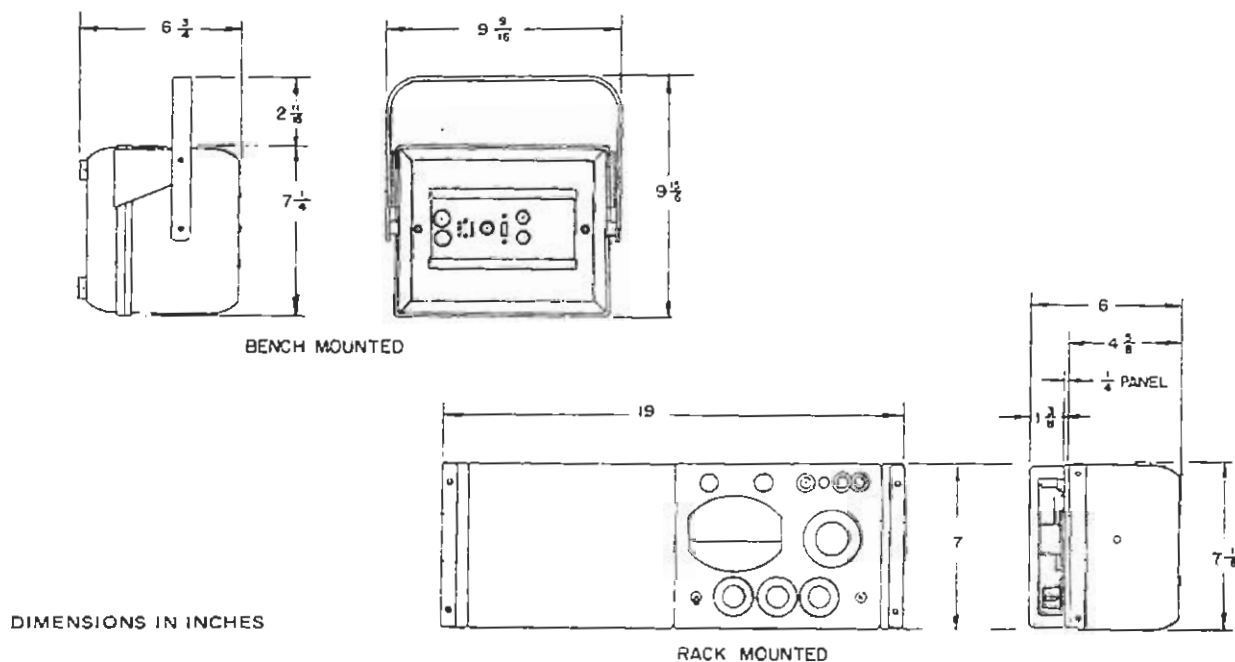

Figure 2-1. Dimensions of the GR 1863 and 1864 Megohmmeters.

2.1 DIMENSIONS.

The dimensions of the 1863 and 1864 are shown in both the rack- and bench-mounted configurations in Figure 2-1.

2.2 BENCH MOUNTING.

The bench (portable) model of the megohmmeter is cased in a Flip-Tilt cabinet. The cabinet opens by pushing down on the handle and tipping the instrument into the desired operating position (paragraph 1.2).

2.3 POWER CONNECTIONS.

The 1863 and 1864 Megohmmeters can be operated from either a 100- to 125-V or a 200- to 250-V, 50-to 60-Hz power line. Before connecting the 3-wire power cord to the line, set the slide switch on the rear panel to the

proper setting as indicated by the position of the white line on the slide switch. The slide can be moved with a screwdriver blade. The fuses installed in the instrument are connected so that they will protect the unit for either voltage. If it is necessary to use a 3-wire adaptor plug, make certain that the third wire is connected to a good ground (water pipe or equivalent). If this is not possible, connect the panel of the 1863 or 1864 (uninsulated binding post) to a good ground.

2.4 RACK MOUNTING.

2.4.1 Single Instrument and Blank Panel (Figure 2-2).

A Rack Adaptor Set (P/N 0480-9744) is available to convert the portable bench model for use in an EIA opposite directions, one from inside the cabinet and one

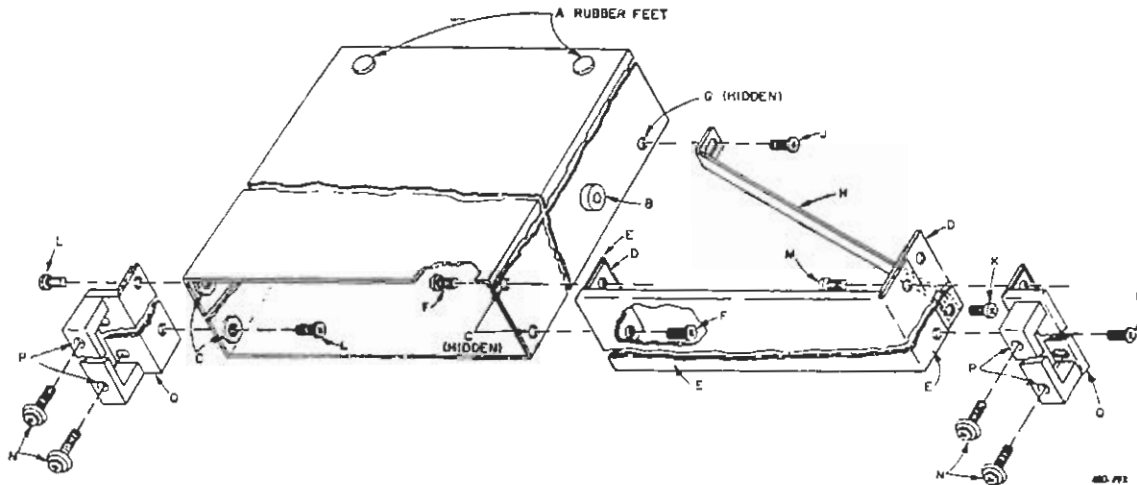

Figure 2-2. Rack mounting a GR 1863 or 1864.

standard RS-310 19-inch relay rack with universal mounting hole spacing. Table 2-1 lists the parts included in the Rack Adaptor Set. The conversion procedure is as follows (Figure 2-2):

Table 2-1

PARTS INCLUDED IN THE RACK ADAPTOR SET,
P/N 0480-9744 (see Figure 2-2).

Figure 2-2 Reference	Number Used	Item	GR Part Number
E	1	Blank Panel	0480-8934
D	1	Sub-Panel	0480-8954
—	2	Rack Adaptor Assembly (handle)	0480-4904
H	1	Support Bracket	0480-8523
—	1	Hardware Set includes:	0480-3080
F, J, K, L, M		8 Screws, Binder-Head 10-32, 5/16 in.	—
N		4 Screws, Binder-Head 10-32, 9/16 in. with nylon cup washer	—

a. Open the instrument so that the front-panel makes a 90-degree angle with the base.

b. From the rear, remove the two No. 10-32 screws that hold the instrument in the cabinet.

c. Slide the instrument forward out of the cabinet.

d. Remove the two O-rings, one on each side of the cabinet (Figure 7-10, P/N 5210-0200). (Use Waldes TRUARC* Assembly Pliers No. 0100 or equivalent.)

e. Remove the two pins (Figure 7-10, pivot shaft), one from each side of the cabinet, and slide the cabinet from between the handle ends.

f. Pierce and push out the plugs from the four bosses (C) on the inner sides of the cabinet, near the front. Do not damage the threads in the threaded holes.

g. Press the subpanel (D) into the blank panel (E), to form a liner for the latter.

h. Attach the short flange of the blank panel to the front of the cabinet (on either side of the cabinet, as desired) using two 5/16-in. screws (F). Note that the screws enter in opposite directions — one from inside the cabinet and one from the flange side, as shown and that the feet (A) are on top.

i. Pierce and push out the plug in the lower rear boss (G) on the side toward the blank panel only, as shown.

j. Attach one end of the support bracket (H) to the lower rear boss. The bracket must be placed so that the screw passes through a clearance hole, into a tapped hole. Lock the bracket in position with a 5/16-in. screw (J).

k. Attach the other end of the support bracket to the lower, rear hole in the wide flange, as shown, using a 5/16-in. screw (K).

l. Attach one Rack Adaptor Assembly (handle) to the side of the cabinet opposite the blank panel, using two 5/16-in. screws (L). Again, note that the screws enter in

*Registered trademark of Truarc Retaining Rings Division, Waldes Kohinoor, Inc., Long Island City, N.Y. 11101.

from outside. Use the upper and lower holes in the Assembly.

m. Attach the other Rack Adaptor Assembly (handle) to the wide flange on liner (D) and the flange on the blank panel (E). Use two 5/16-in. screws (M) through the two holes in the flange that are nearest the panel and through the upper and lower holes in the Assembly. Again, the screws enter in opposite directions.

n. Carefully remove the rubber gasket that is around the instrument panel. Note: Use fingers, not tools.

o. Install the instrument in the cabinet and replace the two No. 10-32 screws removed in step b through the rear panel and tighten.

p. Place a straight edge across both the instrument panel and the blank panel. Loosen the screw (J) through the slot in the support bracket (H). Exert a slight pressure on the blank panel (E) so that it forms a straight line with the instrument panel, and tighten the screw (J) in the bracket, to lock the panels in this position.

q. Slide the entire assembly into the relay rack and lock it in place with the four 9/16-in. screws (N) with captive nylon cup washers. Use two screws on each side and tighten them by inserting a screwdriver through the holes (P) in the handles.

r. Insert the instrument at a slight angle, left end first, to avoid hitting the cabinet spacer on the rack rail. If your rack won't allow this procedure, refer to paragraph 2.4.3 and read the CAUTION.

2.4.2 Reverting to Portable Bench Mounting.

To revert the instrument for bench use, (assuming the procedure of paragraph 2.4.3 has not been performed) reverse the procedures of paragraph 2.4.1, first removing the entire assembly of instrument, cabinet, and blank panel from the rack. Next remove:

- a. The instrument from its cabinet.
- b. The support bracket (H) from the cabinet (see Figure 2-2).
- c. The blank panel (E) (with handle attached) from one side of the cabinet.
- d. The Rack Adaptor Set (handle) from the other side of the cabinet.

Install the instrument in its cabinet and tighten the two No. 10-32 screws at the rear.

2.4.3 Rack-mounting Two Instruments.

Two instruments of the same panel size (such as two 1863's or 1864's or one of each) can be mounted

side-by-side in a standard 19-inch relay rack. Use the procedure of paragraph 2.4.1, substituting the second instrument for the blank panel. Do not use the support bracket (H, Figure 2-2), but insert three screws through the bosses in the adjacent sides of the cabinets, two near the front (C) and one near the rear (G).

When two instruments are mounted side-by-side, the two spacers (B, one on each side of the cabinet) must be punched out of the cabinet.

CAUTION

Once this is done the instruments cannot be reinstalled in a Flip-Tilt cabinet.

Use the four screws (N) with nylon washers to lock the instruments in the rack. The required hardware is listed below:

3 Screws, BH 10-32 5/16

4 Screws, BH 10-32, 9/16 with nylon washers

2.5 LINE-VOLTAGE REGULATION.

The accuracy of measurements accomplished with precision electronic test equipment operated from ac line sources can often be seriously degraded by fluctuations in primary input power. Line-voltage variations as much as $\pm 5\%$ are commonly encountered, even in laboratory environments. Although most modern electronic instruments incorporate some degree of line-voltage regulation, consideration to possible power-source problems should be given for every instrumentation set-up. The use of line-voltage regulators between power lines and the test equipment is recommended as the only sure way to eliminate the effects on measurement data by low line voltage, transients, and other power phenomena.

The General Radio Type 1591 Variac® Automatic Voltage Regulator is a compact and inexpensive unit capable of holding ac power within $\pm 0.2\%$ accuracy for up to a rack full of solid-state instrumentation. The 1591 possesses a basic capacity of 1 kVA with no distortion of input waveform. This rugged electromechanical regulator comes in bench or rack-mount configurations, both of which permit direct plug-in of measurement-instrument power cords.

Operation—Section 3

3.1 MEASUREMENT SETUP	3-1
3.2 MEASUREMENT PROCEDURE	3-1
3.3 OUTPUT JACK	3-2

3.1 MEASUREMENT SETUP.

3.1.1 Ground-Link Connection.

The grounding link connected to the uninsulated, grounded, binding post can be connected from this ground terminal to the GUARD (paragraph 4.6) or the + UNKNOWN terminal (Figure 3-1). The ground link should be connected to the GUARD terminal if the sample to be measured is a small, separate component, or if it is a component mounted in an enclosure that should be guarded (paragraph 4.6). However, if one terminal of the unknown must be grounded, then the link should tie the + UNKNOWN terminal to the instrument case.

3.1.2 Test Voltage Selection.

The TEST VOLTAGE switch(es) should be set to the desired measurement voltage. The 1863 Megohmmeter has five individual test voltages, 50, 100, 200, 250, and 500 V. The 1864 Megohmmeter has a selection of 10 to 109 V in 1-V steps or 100 to 1090 V in 10-V steps. On the 1864 the right-hand TEST VOLTAGE switch must be set to the V position for the first set of voltages and to the 0V position for the latter set of voltages.

3.1.3 Set ∞ Adjustments.

To adjust the SET ∞ controls, proceed as follows:

- Turn the instrument on.
- Set the function switch to DISCHARGE.
- Set the multiplier dial to any range.

d. Make certain that there isn't anything connected to the UNKNOWN terminals.

e. Adjust the SET ∞ control for an ∞ reading on the meter. The adjustment on the 1863 is made with a screwdriver; on the 1864 with the knob provided.

f. Set the multiplier switch to the highest range (Type 1863, 1T-100G; Type 1864, 10-1T).

g. Set the function switch to MEASURE.

h. Adjust the SET ∞ HIGHEST RANGE on the 1863 (screwdriver adjustment) or 1864 (knob adjustment) for an ∞ meter reading. If these adjustments cannot be set to give an on-scale reading, turn the instrument off and adjust the mechanical meter adjustment (the center screw on the meter) to give a meter reading of less than a line width beyond ∞ . Repeat steps a through g.

3.1.4 Connection of Unknown.

Small components should be connected directly to the UNKNOWN terminals. Insulated leads (GR 274-LSR Single-Plug Patch Cord, Table 1-4) can be connected to a nearby unknown, however, if the unknown resistance is high, leakage between the leads will cause a measurement error and changing capacitance to the high lead will cause a transient meter deflection. For such high resistance measurements, a shielded system is preferable (refer to paragraph 4.7).

3.2 MEASUREMENT PROCEDURE.

3.2.1 General.

Either of two measurement procedures is used, depending on whether or not the correct resistance-multiplier range is known. If the range is not known, the search procedure (paragraph 3.2.2) should be followed. If repetitive measurements are to be made on a given range (i.e., if similar components are to be sorted) the sort procedure (paragraph 3.2.3) should be used.

3.2.2 Search Procedure.

When the approximate resistance of the sample to be measured is not known, proceed as follows:

- Set the multiplier switch to the lowest range.
- Set the function switch to DISCHARGE.

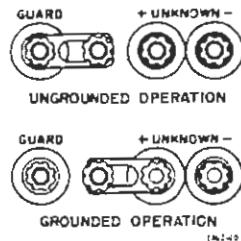

Figure 3-1. Ground-link connection to GUARD terminal (top) and to + UNKNOWN terminal (bottom).

- c. Connect the unknown between the UNKNOWN + and – terminals.
- d. Set the function switch to MEASURE.
- e. Rotate the multiplier switch cw until the meter gives a reading of less than 5.
- f. The resistance of the unknown is the meter reading multiplied by the multiplier-switch indication.

3.2.3 Sort Procedure.

When the approximate resistance of the unknown is known, proceed as follows:

- a. Set the function switch to DISCHARGE.
- b. Set the multiplier switch to the desired range.
- c. Connect the unknown between the UNKNOWN + and – terminals.
- d. Set the function switch to MEASURE.
- e. The resistance of the unknown is the meter reading multiplied by the multiplier-switch indication. For go-no-go checks, it is often useful to make a limit line on the outside of the meter case with a strip of masking tape.

3.2.4 Shock Hazard.

Every precaution has been taken in the design of the Types 1863 and 1864 Megohmmeters to reduce the possibility of shock. However, high voltage must be present at the terminals to make measurements at the required voltage levels and the operator should be aware of the dangers involved.

The current delivered by the megohmmeters under short-circuit conditions is approximately 5 mA. This 5-mA current is not lethal to most persons but might be lethal to those with poor hearts, and it is painful to all. The actual current that will flow through a person depends on the resistance of the part of the body that makes contact with the terminals. This resistance can be as low as 300 Ω. Note that any of the three insulated binding posts can be at high voltage, depending on the position of the shorting link.

When capacitors are tested there is an especially dangerous condition because a charged capacitor easily can have enough energy to cause heart fibrillation and death. The capacitor should *always* be shunted before connection to the megohmmeter, and the function switch should be set to DISCHARGE for a few seconds before the capacitor is disconnected.

We strongly recommend that additional precautions, such as rubber gloves and insulated bench tops, chairs and shoes should be used for anyone making repetitive measurements with the megohmmeter, particularly measurements on capacitors. These precautions should *not* take the place of careful discharge of the capacitors before and after measurement, but should be used as an *additional* safety measure.

3.3 OUTPUT JACK.

The OUTPUT jack (J105) on the rear panel makes accessible a dc voltage that is directly proportional to the reciprocal of the meter reading, that is, the highest value is at 0.5 scale reading and the lowest value is at ∞. The output voltage for a particular multiplier-switch setting can be calculated by

$$V_{out} = 0.02 V_{TEST} \times \frac{R_{RANGE}}{R_x}$$

where V_{TEST} is the TEST VOLTAGE setting, R_{RANGE} is the lower value for a particular multiplier-dial setting (100k for the 1M/100 k range) and R_x is the value of the resistance being measured.

The output can be plotted on a dc level recorder, such as the GR 1521 Graphic Level Recorder (P/N 1521-9802) with a 1521-P4 Linear Potentiometer (P/N 1521-9604) and a general use, 1/4 in. division chart paper (P/N 1521-9428). A GR 1560-P95 Adaptor Cable can be used to connect the OUTPUT jack to the recorder. The full-scale voltage value for any test voltage can be calculated from the V_{out} formula using 0.5 times the measurement range as the R_x value. Table 3-1 lists the full-scale voltage values for the five test voltages of the 1863. These values are also available on the 1864 along with the other levels that can be set with the variable TEST VOLTAGE switches.

The GR 1782 Analog Limit Comparator can be used to establish limits for go-no-go checks of a series of components being measured by 1863 or 1864. The 1782 has a full-scale voltage of 10 V, whereas the maximum voltage from the megohmmeters is 4 V. The fact that a full-scale value cannot be reached does not affect the usefulness of the comparator with the megohmmeters.

**Table 3-1
OUTPUT VOLTAGE***

Test Voltage (V)	Lower Multiplier-Dial Setting		Upper-Multiplier-Dial Setting		
	50	100	200	250	500
Full-Scale Output Voltage (V)	2	4	0.8	1	2

* V_{OUT} at 0.5 scale reading.

Applications – Section 4

4.1 INSULATION TESTING	4-1
4.2 TEST SAMPLE RESISTIVITY MEASUREMENTS	4-2
4.3 CAPACITOR INSULATION RESISTANCE	4-2
4.4 RESISTANCE MEASUREMENTS	4-3
4.5 MEASUREMENT OF VOLTAGE COEFFICIENTS	4-3
4.6 GUARDED, 3-TERMINAL MEASUREMENTS	4-3
4.7 REMOTE SHIELDED MEASUREMENTS	4-4
4.8 MEASUREMENTS UNDER HUMID CONDITONS	4-4

4.1 INSULATION TESTING.

The insulation resistance of electrical machinery, transducers, etc, is one of several parameters that may indicate the condition of the insulation. Routine measurement of capacitance, dissipation factor, and leakage resistance provides useful data for monitoring the condition of the insulation and for guarding against incipient breakdown.

A routine test that has been widely adopted for insulation testing calls for the measurement of the apparent leakage resistance after a test voltage has been applied for one minute and again after the test voltage has been applied for 10 minutes. The ratio of the indicated resistances, sometimes referred to as the Polarization Index, can have some relation to the condition of the Insulation. The results of such a measurement are apt to be more dependent on the dielectric absorption of the insulator than on its true leakage resistance measured at equilibrium. A complete charge-current-vs-time plot will provide more useful information.

The Type 1863 and 1864 Megohmmeters can be used for either true leakage measurements or for measurements at 1- or 10-minute intervals following the operating procedure described in Section 3. MIL-STD-202C gives procedures for insulation-resistance measurements of various components. On large machinery, one terminal must usually be grounded, so the grounding strap should be connected between the ground terminal and the + UNKNOWN terminal.

To determine the charge current, divide the test voltage by the indicated resistance. At the start of a

Table 4-1
STANDARD RESISTOR VALUES (R_{ξ})

Multiplier Range		Value (Ω)
Lower Dial	Upper Dial	
50, 100 V* 10 to 109 V†	200, 250, 500 V* 100 to 1000 V†	
100 k	1M	2 k
1 M	10 M	20 k
10 M	100 M	200 k
100 M	1 G	2 M
1 G	10 G	20 M
10 G	100 G	200 M
100 G	1 T	200 M with feedback multiplication* 2 G†
1 T	10 T	2 G with feedback multiplication†

* Type 1863 Megohmmeter
† Type 1864 Megohmmeter

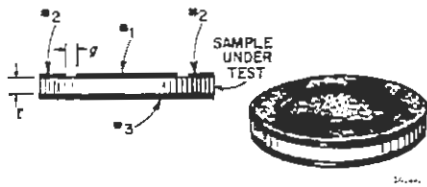

Figure 4-1. Electrode arrangement for resistivity measurements.

charge-current-vs-time plot, the meter will be off scale. The resistance in series with the insulator is the reading of the upper dial multiplier divided by 500. Table 4-1 lists dial readings and resistor values.

4.2 TEST SAMPLE RESISTIVITY MEASUREMENTS.

The megohmmeter can be used for measuring the resistivity of test samples as described by ASTM Standard D257, which describes in detail the techniques for both surface- and volume-resistivity measurements. The most common electrode arrangement is that shown in Figure 4-1. In this configuration surface resistivity is measured with terminal 1 tied to the -UNKNOWN terminal, terminal 2 tied to the +UNKNOWN terminal and terminal 3 tied to GUARD. For volume resistivity measurements, terminal 1 is tied to the -UNKNOWN terminal, terminal 2 to the GUARD and terminal 3 to the +UNKNOWN terminal. The formulas required to convert from measured resistance to resistivity are given in the ASTM standard. The Keithley Model 6105 Test Fixture can be used to hold the sample to be measured.

4.3 CAPACITOR INSULATION RESISTANCE.

4.3.1 General.

The insulation resistance, IR, of capacitors (MIL-STD-202 C) is measured by either the search or sort method (paragraph 3.2.2 and 3.2.3) used for resistors, except that some consideration must be given to the charge and discharge currents.

WARNING

Capacitors being measured may be charged and contain lethal energy. Always set the function switch to DISCHARGE before connecting or disconnecting the capacitor under test.

4.3.2 Charging Time Constant.

The time constant for charging a capacitor in the CHARGE position is determined by the value of the capacitor times the effective source impedance of the supply. The supply resistance is approximately,

$$R_o = \frac{E}{I_{max}} \Omega = \frac{E}{0.005 A} \Omega = \frac{E}{5} k\Omega$$

where E is the indicated test voltage in volts and I_{max} is the short-circuit current, which is approximately 5 mA. Therefore, the time constant is

$$T = R_o C_x = \frac{E C_x}{5000} \text{ seconds}$$

where C_x is in μF . As an example, on the 500-V range, R_o is approximately 100 k Ω so that the time constant for charging of a 1- μF capacitor is 0.1 s.

The time necessary for full charging depends on the type of capacitor and the leakage current that is to be measured. A capacitor with no dielectric absorption will have a charging current that decreases by a factor of 2.72 (the natural logarithm to the base e) for every time constant it is left in the CHARGE position. Thus, the effective resistance

at any moment is $R_o e^{-\frac{t}{R_o C_x}}$. The capacitor could be considered fully charged when this resistance is substantially higher than the true leakage resistance, even though the charging current theoretically never reaches zero. As an example a 1- μF capacitor, with a leakage resistance of $10^{10} \Omega$ measured at 500 V, would have less than 1% error due to charging current, if measured after seventeen time constants, or 1.7 s.

Dielectric absorption (dipole and interfacial polarization) is present in many capacitors and insulators, especially those with a laminated structure. When voltage is applied to such material, the charge slowly diffuses throughout the volume and several minutes, hours, or even days, are required for equilibrium in order to make the charging current small compared with the true leakage current. A measure of this effect, called the Polarization Index, is the ratio of the resistance measured after 10 minutes of charging to that measured after 1 minute of charging. Often, the measured resistance after 1 minute of charging is called the insulation resistance, even though charging current may be much larger than the true leakage current. (Some capacitor specifications say less than 2 minutes).

4.3.3 Measurement Time Constant.

When the function switch is set from the CHARGE position to the MEASURE position, the standard resistor is placed in series with the unknown capacitor. If the supply voltage is fixed, the capacitor must discharge by a voltage equal to that across the voltmeter at its final reading. The time constant for this discharge would be $C_x R_s$. Because 80% of the output voltage is fed back to the supply, this time constant is reduced by a factor of 5. As a result, the time necessary for an indication, assuming an ideal capacitor, depends on this time constant or that of the meter movement, whichever is longer.

4.3.4 Discharge Time.

With the function switch set at DISCHARGE, the UNKNOWN terminals are connected through 470 Ω and the discharge time is approximately $0.0005 \times C \mu s$, where C is in μF . The red DANGER light is turned off by the

function switch, so that the capacitor might be charged even after the light is extinguished. However, the discharge time is so short that this is not a practical consideration, except for capacitors greater than 100 μF .

Capacitors with high dielectric absorption (paragraph 4.3.2) can have a residual charge even after they are shunted and must be repeatedly shunted to be completely discharged. Usually this "voltage recovery" is only a few percent (i.e., 3%) of the original applied voltage and, therefore, not dangerous to the operator, but it can cause damage to sensitive circuit elements.

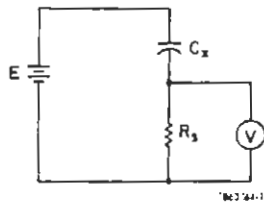

Figure 4-2. Basic megohmmeter circuit.

4.3.5 Large Capacitors, Very High Resistance

Measuring insulation resistance of large capacitors that have very low leakage is difficult by any method. Considering the basic circuit of Figure 4-2, if R_s is high, the $R_s C_x$ time constant can become very long on the high resistance ranges if C_x is large. If R_s is low, the voltmeter must be very sensitive for a given leakage resistance range and, therefore, the supply voltage (E) must be extremely stable to avoid large meter fluctuations. The design of the 1863 and 1864 is a compromise between these factors. Measurements become difficult when the $R_s C_x$ product is 10^6 , even under ideal conditions. This can be calculated as (C_x in μF) \times (R_s in $\text{M}\Omega$) or (C_x in F) \times (R_s in Ω). Table 4-1 contains values for R_s .

Measurements can be unsatisfactory even below this value for an $R_s C_x$ product for several reasons:

- 1 Dielectric absorption. (paragraph 4.3.2). This is the main cause of erroneous readings. Besides the difficulty in deciding what charging period should be used, the previous history of the capacitor will greatly affect its indicated leakage. For example, if a paper capacitor is charged to its rated value, discharged for a short time, and then its leakage current is measured at some low value, it probably will give a reading beyond ∞ . This is due to voltage recovery that is a consequence of dielectric absorption. The voltage across the capacitor will increase above the test voltage causing current to flow in the reverse direction.

2. Temperature coefficient. If the temperature on the unknown changes and it has an appreciable temperature coefficient, the voltage on the capacitor will change in the MEASURE position. If R_s is large, the charge, Q , of the capacitor is more-or-less constant, so if its capacitance

changes, its voltage must change ($Q=CV$). A temperature-controlled environment is recommended.

3. Test voltage changes. The test voltage can have rapid fluctuations due to large line-voltage transients even though good regulation is provided in the instrument because when $R_s C_x$ is large, the test voltage fluctuations are transmitted directly to the voltmeter unattenuated. This difficulty can be reduced if the line voltage is regulated with an instrument such as GR 1591 Variac® Automatic Voltage Regulator.

Slow drift of the test voltage can cause erroneous readings if $R_s C_x$ is large, because even a slow drift rate can be fast compared to the $R_s C_x$ time constant. A decreasing test voltage can cause a reading beyond ∞ . Sufficient warm-up time (30 minutes) will allow the temperature inside the megohmmeter to stabilize and result in a more constant voltage at the UNKNOWN terminals.

4.4 RESISTANCE MEASUREMENTS.

The recommended test voltage is 100 V for fixed composition resistors, film resistors, and wire-wound resistors above 100 $\text{k}\Omega$. (Refer to EIA Standards RS172, RS196, and REC 229.) These resistors can be measured easily on the megohmmeter as long as the accuracy of the instrument is adequate. If the resistors are separate, we suggest that they be measured ungrounded (with the grounding link connected to the GUARD terminal).

4.5 MEASUREMENT OF VOLTAGE COEFFICIENT.

The Types 1863 and 1864 Megohmmeters may be used to measure voltage coefficient as long as its accuracy is adequate. The voltage coefficient of resistance is defined as:

$$\frac{R_1 - R_2}{R_2 (V_1 - V_2)} \times 100\%$$

where $V_1 > V_2$

R_1 is the resistance at V_1 , the higher voltage

R_2 is the resistance at V_2

For example, if $V_1 = 500 \text{ V}$ and $V_2 = 100 \text{ V}$,

$$\begin{aligned} \text{Voltage Coefficient} &= \frac{R_{500\text{V}} - R_{100\text{V}}}{(400) R_{100\text{V}}} \times 100\% \\ &= \frac{1}{4} \frac{\Delta R}{R_{100\text{V}}} \% \end{aligned}$$

This voltage coefficient is usually negative (except for reversed semiconductor junctions).

4.6 GUARDED, 3-TERMINAL MEASUREMENTS.

In many cases it is necessary to measure the resistance between two points in the presence of resistance from each of these points to a third point. This third point can often be guarded to avoid error caused by the extraneous resistances.

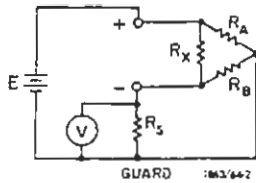

Figure 4-3. Guarded measurement of a three-terminal resistor.

This situation can be shown diagrammatically as a three-terminal resistor (Figure 4-3). Here, R_X is the quantity to be measured in the presence of R_A and R_B . If the junction of R_A and R_B is tied to a guard, R_A is placed across the power supply and has no effect if it is greater than 500 k Ω . R_B shunts R_S and causes a much smaller error than that which would be present if no guard were used. The error is approximately $-R_S/R_B \times 100\%$, where R_S equals the value shown in Table 4-1 for the various ranges. If a choice is possible, the higher of the two stray resistances should be connected as R_B .

The guard terminal can be used whether the GUARD or the + UNKNOWN terminal is grounded, but note that if the + UNKNOWN terminal is grounded, the GUARD terminal will be a high (negative) voltage level. Often the terminal to be guarded is a large chassis and it is, therefore, safer to ground the GUARD terminal. If this third terminal is true ground then the GUARD terminal *must* be grounded.

4.7 REMOTE SHIELDED MEASUREMENTS .

Measurements can be made on components that are some distance from the instrument if care is used to prevent

leakage between the connecting leads and to avoid the shock hazard. A convenient way to do this is to use a shielded cable (Table 1-4). If the unknown can be measured ungrounded, make the connection to the + UNKNOWN terminal with the shielded lead, tie the shield to the GUARD terminal, and connect the GUARD terminal to the panel ground with the connecting link. If one side of the unknown must be grounded, connect the grounding link to the + UNKNOWN terminal, shield the + UNKNOWN terminal, and tie the shield to the GUARD terminal. In this instance, the shield is not at ground potential and should be insulated.

4.8 MEASUREMENTS UNDER HUMID CONDITIONS.

The Types 1863 and 1864 Megohmmeters have been designed to operate under conditions of high humidity but, nevertheless, a few simple precautions should be taken to ensure accurate measurements. These precautions are:

1. Allow several minutes warmup (internal heat will reduce humidity inside the instrument).
2. Clean the binding-post insulation with a dry, clean cloth.
3. Use ungrounded operation (tie the GUARD terminal to the panel ground).

To determine the presence of errors due to humidity, measure the resistance between the binding posts with no external connections. Note that with the + UNKNOWN terminal grounded, breathing on the terminals will cause a meter deflection because leakage from the insulator of the - UNKNOWN terminal to the panel is measured.

Actually, this problem is somewhat academic because the unknown to be measured is usually much more severely affected by humidity than is the megohmmeter.

Theory—Section 5

5.1 GENERAL	5-1
5.2 CIRCUIT DESCRIPTION	5-1

5.1 GENERAL.

The 1863 and 1864 Megohmmeters basically consist of a regulated dc power supply, a set of precision resistors, and a FET-input voltmeter (Figure 5-1). Switch S_1 is closed in the DISCHARGE position of the function switch and open in the CHARGE and MEASURE positions, while S_2 is open only in the MEASURE position.

The regulated voltage, E , is controlled by a resistance R_A . A fraction, E_M , of the meter output voltage, $E_X R_S/R_X$ is added to E to keep the voltage on the unknown, E_X , more constant and thus improve the meter accuracy. A meter sensitivity resistor, R_B , is ganged to the voltage control resistor, R_A , to make the meter reading independent of applied voltage, (assuming that the unknown has no voltage coefficient). An inverse scale is used on a reversed meter to give a reading proportional to R_X (and not its reciprocal) and yet have a scale that increases from left to right (0 to ∞).

Metal-film standard resistors are used on the five lowest ranges (lowest range $\pm\frac{1}{2}\%$ next four ranges $\pm 1\%$). The sixth range in the 1863 uses a 200-M Ω carbon resistor ($\pm 1\%$). The sixth range in the 1864 uses a 200-M Ω carbon resistor ($\pm 1\%$) and the seventh range a 2-G Ω carbon resistor ($\pm 1\%$). The use of carbon resistors makes it necessary to broaden the accuracy specification to include possible drift in this standard. The top range of each instrument uses feedback to effectively multiply the value of the previous standard resistor by a factor of ten. In the 1863 the 200-M Ω resistor is multiplied to 2 G Ω ; in the 1864 the 2-G Ω resistor is multiplied to 20 G Ω . The specifications are again broadened to allow for the tolerance variations of this multiplication.

The voltmeter uses a FET-input, four-stage, unity-gain amplifier (AMP, Figure 5-1) to obtain high stability and low drift. The SET ∞ control on both instruments is a voltage balance control, while the SET ∞ HIGHEST RANGE control compensates for the FET gate current on the highest ranges.

5.2 CIRCUIT DESCRIPTION.

5.2.1 General.

The following paragraphs will relate specific components from the schematic diagrams of the 1863 (Figure 7-6) and 1864 (Figure 7-9) to the general components shown in Figure 5-1.

5.2.2 Type 1863 Megohmmeter (Figure 7-6).

The voltage supply section (RECT.) of the 1863 consists of five different circuits, three dc and two ac. One ac circuit is a voltage source for the three pilot lamps used, two to indicate the measurement range (P101, P102) and the third to light the DANGER indicator (P103). The second supplies filament voltage to the tube V101.

The first dc supply is a half-wave rectifier circuit with a 24-V Zener diode (CR111) that supplies voltages to the amplifier (AMP) circuit. A second dc supply is a voltage doubler (CR101-CR104, C101-C102) that supplies the plate voltage to V101. The voltage to the plate is the same for the 50- to 250-V ranges but R109 is eliminated from the circuit for the 500-V range. The third dc supply is a half-wave rectifier with a 20-V Zener diode (CR211) to supply voltage levels to run the unity-gain amplifier (+1).

Tube V101 is a series regulator that is controlled by the 5.6-V Zener diode (CR112, REF) and the setting of R140.

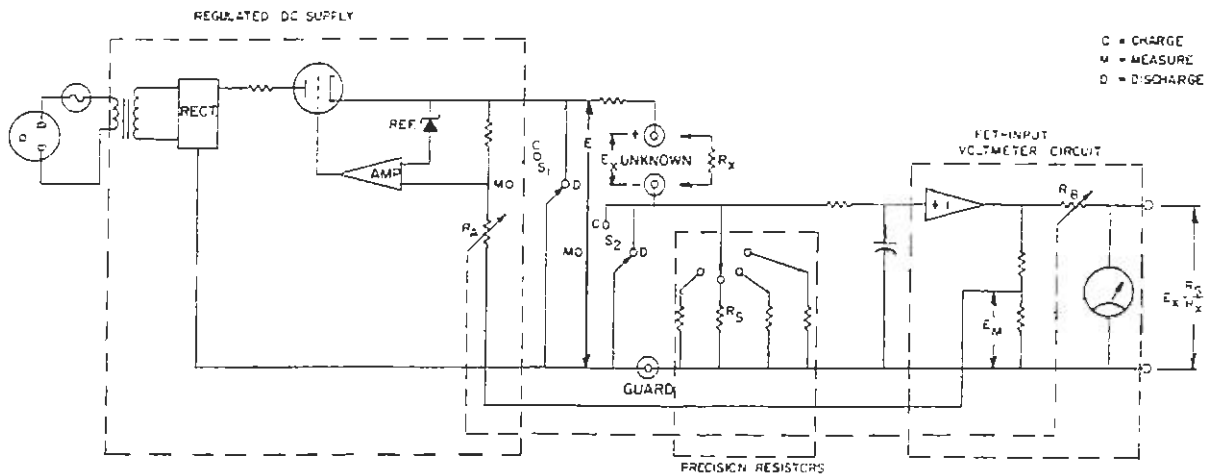

Figure 5-1. Megohmmeter block diagram.

The voltage picked off R140 is fed into one side (Q102) of the differential amplifier (Q102, Q103) while part of the output voltage is fed into the other side (Q103). The output of the amplifier is fed to the base of Q101 (AMP) and then to the grid of V101 for controlling the output voltage.

The output selection resistors are R124 through R127 (R_A). These resistors along with the voltage (E_M) developed across R138 determine the TEST VOLTAGE level. Resistors R211 through R219 are the standard resistors (R_S) that determine the measurement range. The output from this circuit is fed through the SET ∞ HIGHEST RANGE control (R241) to the FET amplifier.

A unity-gain FET-input amplifier (+1) follows the standard resistors in the circuit configuration. R210 and C203 comprise a low-pass filter input to FET Q204. The amplifier components include a differential amplifier (Q202, Q203), a coarse ∞ control (R244), the SET ∞ control (R242) and an output transistor (Q201). The signal then enters the series combination of R135 and R134 back to the GUARD terminal.

Resistors R221 through R223 (R_B) are meter-sensitivity resistors that are ganged to the voltage resistors R124

through R127 (R_A). R222 is used for both the 50- and 500-V ranges, while the 200-V range uses the circuit resistance and has no added resistor. The remaining two resistors, R221 and R223, are used for the 250- and 100-V ranges, respectively. Potentiometer R243 is an adjustable control on the meter sensitivity.

5.2.3 Type 1864 Megohmmeter (Figure 7-9).

The circuit of the 1864 Megohmmeter is basically the same as that of the 1863 (paragraph 5.2.2). The exceptions are explained in the following paragraphs.

In the 1864 the second dc power supply is a quadrupler. This supply establishes the plate voltage of V101 with the use of resistors R109 through R114.

The regulator circuit has a slightly different input when the TEST VOLTAGE switch is switched from V (1) to 0V (10). Resistors R124 and R125 are switched out of the circuit in the 0V (10) position.

Voltage-selection resistors for the 1864 are R126 through R133 and the meter sensitivity resistors are R221 through R228. An additional range resistor, R220, is in the 1864.

Service and Maintenance—Section 6

6.1 SERVICE	6-1
6.2 MINIMUM-PERFORMANCE STANDARDS	6-1
6.3 CABINET REMOVAL	6-2
6.4 TROUBLE ANALYSIS	6-3
6.5 CALIBRATION PROCEDURE	6-3
6.6 KNOB REMOVAL	6-4
6.7 KNOB INSTALLATION	6-5

WARNING

Dangerous voltages are present inside this case. When troubleshooting, a ground strap should be connected between GUARD and GROUND on panel to keep sub-panel (Guard) at ground potential. Refer all servicing to qualified service personnel.

6.1 SERVICE.

The warranty attests the quality of materials and workmanship in our products. When difficulties do occur, our service engineers will assist in any way possible. If the difficulty cannot be eliminated by use of the following service instructions, please write or phone our Service Department (see last page of manual), giving full information of the trouble and of steps taken to remedy it. Be sure to mention the type, ID, and serial numbers of the instrument.

Before returning an instrument to GenRad for service, please write to our service department or nearest District Office, requesting a "Returned Material Tag." Use of this tag will ensure proper handling and identification. For instruments not covered by the warranty, a purchase order should be forwarded to avoid unnecessary delay.

6.2 MINIMUM-PERFORMANCE STANDARDS.

The following checks are provided for checking the operation of the 1863 and 1864 Megohmmeters. The test equipment necessary to perform these checks is listed in Table 6-1. To check an instrument, proceed as follows:

- Connect the case to the GUARD terminal with the shorting link.
- Set the decade resistor to 0500000 (500 k Ω).
- Set the TEST VOLTAGE switch to 100 on the 1863 or to 1-0-0V on the 1864.
- Set the multiplier switch to 1M.
- Set the POWER-OFF switch to POWER.
- Adjust the two SET ∞ controls as described in Section 3,

g. Connect a GR 1433-H Decade Resistor to the UNKNOWN terminals with a GR 274-NP Double-Plug Patch Cord.

h. Set the function switch to MEASURE.

i. Read the panel meter. The reading will be $0.5 \pm 3\%$, that is, $\pm 2 (1 + \text{meter reading})\%$ or $2 (1 + 0.5) = 3\%$.

j. Set the decade resistor to 1000000 (1 M Ω).

k. The meter will read $1 \pm 4\%$.

l. Set the decade resistor to 5000000 (5 M Ω).

m. The meter will read $5 \pm 12\%$. The checks of steps a through m are for meter tracking.

n. Set the TEST VOLTAGE switch to 50 on the 1863 and to 10 V on the 1864.

o. Set decades to 5000000 (5M Ω) MULTIPLIER to 10M.

p. The meter will read $0.5 \pm 3\%$.

q. Increase the voltage to the next higher step (100 on the 1863, 20 V on the 1864).

r. The meter reading will remain the same.

s. Continue to increase the voltage settings and observe that the meter reading remains at $0.5 \pm 3\%$. These readings will check the voltage accuracy.

NOTE

When the light under the 1M on the multiplier switch goes out, the switch must be rotated so that the 1M on the adjacent scale is lighted.

t. Set the POWER-OFF switch to OFF and disconnect the decade resistor.

Table 6-1
TEST EQUIPMENT

Name	Function	Recommended Equipment*
DECADE RESISTOR	Standard resistor ($\pm 0.02\%$) for checking ranges (500 k Ω to 10 M Ω).	GR 1433-H Decade Resistor (P/N 1433-9733)
MEGOHM BRIDGE	Bridge for measuring the standard resistors of the megohmmeter.	GR 1644 Megohm Bridge
PATCH CORD	Connects decade resistor to megohmmeter.	GR 274-NP Double-Plug Patch Cord, Right-Angle Plug, 36-in. long (P/N 0274-9980)
PATCH CORD	Connect megohm bridge to megohmmeter (3 required).	GR 274-LLB Single-Plug Patch Cord, black, 36-in. long (P/N 0274-9468)
EVM	Measurement of dc and ac voltages.	Data Precision 3400 Digital Voltmeter
SCREWDRIVER	No. 2 Phillips-head screwdriver for internal adjustments.	Xcelite Type X-102 Phillips Screwdriver

*or equivalent

u. Connect the GR 1644 Megohm Bridge between the GUARD and -UNKNOWN terminals with two GR 274-LLB Single-Plug Patch Cords. Connect the two ground terminals together with a third patch cord (Figure 6-1). Leave the megohmmeter shorting link attached only to the ground terminal.

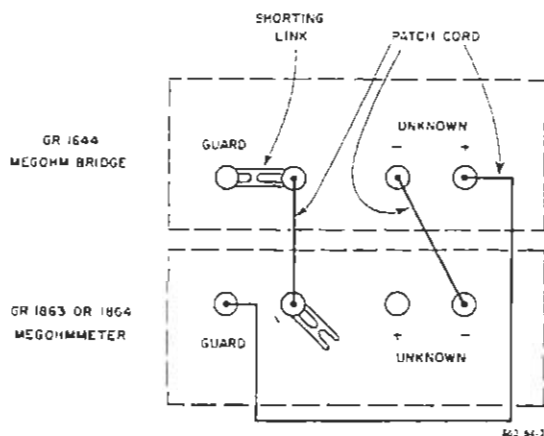

Figure 6-1. Connections for measuring standard resistors with the GR 1644 Megohm Bridge.

v. Set the multiplier switch in the full ccw position (1M, 100k) and the function switch to MEASURE.

w. Measure the various standard resistors of the megohmmeter with the megohm bridge according to the settings and tolerances of Table 6-2. Take into consideration the 1644 bridge-accuracy tolerance for the final measurement. Use a test voltage of 10 V.

6.3 CABINET REMOVAL.

To remove the instrument from the cabinet, remove the two screws on the rear of the instrument cabinet and pull the instrument out of the cabinet.

WARNING

Be careful when trouble shooting the instrument when it is out of its cabinet and connected to the power line. Dangerous voltages are present, particularly at the transformer terminals. Connect the shorting link between the GUARD and ground terminals to keep the voltmeter circuitry near ground potential.

Table 6-2
STANDARD RESISTOR MEASUREMENTS

Multiplier Switch Setting	Standard Resistor Value (Ω)	Measurement Tolerance (%)
1M 100k	2 k	1
10M 1M	20 k	1
100M 10M	200 k	1
1G 100M	2 M	1
10G 1G	20 M	1
100G 10G	200 M [†]	2
1T 100G	2 G ^{†‡}	2
10T* 1T	—	—

[†] This value only appears as a fixed resistor in the 1864. Since the value is determined by feedback multiplication of the 200-M Ω resistor in the 1863, no measurement should be made with the megohm bridge.

* This range only appears on the 1864. Its range value is determined from the feedback multiplication of the 2-G Ω resistor, therefore, no measurement should be made with the megohm bridge.

[‡] In some cases it may be necessary to wait an extended period of time with the instrument power off before making this measurement. If a measurement must be made immediately:

- Remove instrument from case: See para. 6.3.
- Disconnect wire to AT2 on Detector Board.
- Reverse unknown connections on 1644 bridge.
- Perform measurements per Table 6-2.
- Reconnect wire to AT2 and install instrument in case.

6.4 TROUBLE ANALYSIS.

6.4.1 General.

The following information is designed to assist in troubleshooting the 1863 and 1864 Megohmmeters. An understanding of the theory involved in these instruments (Section 5) makes the instrument easy to analyze because the difficulty can usually be located quickly in either the voltage regulator or in the meter circuit.

If the instrument is completely inoperative, be sure to check the power-line connection and the fuses (located on the rear panel).

6.4.2 Test Voltages.

Tables 6-3 and 6-4 list a number of typical test voltages

Table 6-3
TYPE 1863 TEST VOLTAGES*

Test Point (+)	Test Point (-)	Voltage (V)
CR105 Anode	Q101 Emitter	-17.4
Q101 Collector	Q101 Emitter	13.4
Q101 Base	Q101 Emitter	0.5
Q102 Base	Q101 Emitter	18.8
Q102 Emitter	Q101 Emitter	19.4
Q103 Base	Q101 Emitter	18.9
AT23	Guard	372
CR101 Cathode	Guard	744
CR102 Cathode	Guard	533
CR103 Cathode	Guard	372
CR104 Cathode	Guard	-0.3
CR201 Cathode	Guard	30.3
Q201 Collector	Guard	14.3
Q201 Base	Guard	0.6
AT6	Guard	8.9
AT10	Guard	8.4
Q202 Emitter	Guard	9.4
Q202 Collector	Guard	-6.2
Q203 Base	Guard	8.7
Q204 Case	Guard	0
Q204 Drain	Guard	8.7
Q204 Source	Guard	0.3
Q204 Gate	Guard	0

* Voltages are dc and the values are typical. Set TEST VOLTAGE switch to 200, function switch to CHARGE, connect the shorting link between the ground terminal and GUARD, and set the multiplier switch to 1 M. Measurements made with a Data Precision 3400 Digital Voltmeter, with 1863 line voltage set at 115 Vac.

to assist in trouble analysis. Figures 6-2 through 6-5 and the diagrams of Section 7 will assist in locating components for testing purposes.

6.5 CALIBRATION PROCEDURE.

6.5.1 General.

The accuracy of the 1863 and 1864 depends on the accuracy of the range resistors, the accuracy of the applied voltages and the meter tracking accuracy. The over-all accuracy can be checked most easily by checking each one of these contributing quantities separately, for to check all points on all ranges at all voltages would require a tremendous number of measurements.

6.5.2 Meter Tracking.

The scale tracking can be easily checked using a decade resistance box with 100-k Ω and 1-M Ω steps, such as the GR 1433-H. Steps a through m of paragraph 6.2 should be performed to check the tracking. If all readings are corrected by the amount of the error at a reading of 0.5 they should be better than the specification.

Table 6-4
TYPE 1864 TEST VOLTAGES*

Test Point (+)	Test Point (-)	Voltage (V)
AT15	Q101 Emitter	24.2
CR105 Anode	Q101 Emitter	-16.0
CR112 Anode	Q101 Emitter	17.9
Q101 Collector	Q101 Emitter	11.7
Q101 Base	Q101 Emitter	0.6
Q102 Base	Q101 Emitter	19.3
Q102 Emitter	Q101 Emitter	19.9
Q103 Base	Q101 Emitter	19.4
CR201 Cathode	AT5	35.7
Q202 Emitter	AT5	14.9
Q203 Base	AT5	14.3
CR104 Cathode	Guard	294
CR103 Cathode	Guard	590
CR102 Cathode	Guard	888
CR101 Cathode	Guard	1178
AT23	Guard	496
AT5	Guard	-5.0
Q201 Collector	Guard	15.4
Q201 Base	Guard	0.6
Q202 Emitter	Guard	10.0
Q204 Case	Guard	0
Q204 Drain	Guard	9.3
Q204 Source	Guard	0.8
Q204 Gate	Guard	0
AT6	Guard	9.6
AT10	Guard	9.1
CR201 Cathode	Guard	30.6
Q203 Base	Guard	9.3

* Voltages are dc and the values are typical. Set the TEST VOLTAGE switch to 200, function switch to CHARGE, connect the shorting link between the ground terminal and GUARD, and set the multiplier switch to 1 M. Measurements made with a Data Precision 3400 Digital Voltmeter, with 1864 line voltage set at 115 Vac.

6.5.3 Voltage Accuracy.

While the voltage can be checked to be within its specification, a more important check is to see that the voltage and meter sensitivity track to give a correct resistance reading. Such a check is generally adequate for it would be an unusual coincidence if both the voltage-control and meter-sensitivity resistors were both in error, such that a good reading is obtained. To check this tracking, perform steps n through s of paragraph 6.2. If a reading is incorrect, the voltages should be checked with a voltmeter, such as the Data Precision 3400 Digital Voltmeter, connected between the UNKNOWN + and - terminals. The function switch can be set to either the CHARGE or MEASURE positions.

If all the voltages are out of tolerance in the same direction, they can be set within the tolerance by adjusting R140 located on etched-circuit board P/N 1864-2701 (common to both the 1863 and 1864 Megohmmeters and shown in both Figures 6-2 and 6-4). The adjustment can be made as soon as the instrument is removed from the cabinet (paragraph 6.3). It is not necessary to move either of the etched-circuit boards, since the adjustment is on the top etched-circuit board. This adjustment affects all voltages by the same amount, but adjustment at 200 V minimizes possible errors due to resistance tolerances.

If all the voltages are correct but all meter readings are in error in the same direction, the meter sensitivity can be reset. Adjust R243 (Figures 6-2 and 6-4), located on the same etched-circuit board as R140, to correct the meter readings. This adjustment affects all measurements but on the 1863 is most sensitive at 200-V and 250-V and least sensitive at 100 V. In the 1864, it is most sensitive at the lower settings of the first digit of the test voltage adjustment, i.e. 100 V, 200 V, etc.

6.5.4 Range-Resistor Accuracy.

The range resistors can be checked by performing steps t through w of paragraph 6.2.

6.5.5 Coarse ∞ Adjustment.

If it is impossible to set the infinity controls on the front panel, set both controls at their center positions and adjust R244 (Figures 6-2 and 6-4), located on the etched-circuit board with R140, for a reading as close to ∞ as possible. Make the final adjustments with the front-panel controls.

6.6 KNOB REMOVAL.

If it should be necessary to remove the knob on a front-panel control, either to replace one that has been damaged or to replace the associated control, proceed as follows:

a. Grasp the knob firmly with the fingers, close into the panel (or the indicator dial, if applicable), and pull the knob straight away from the panel.

CAUTION

Do not pull on the dial to remove a dial/knob assembly. Always remove the knob first. To avoid damage to the knob and other parts of the control, do not pry the knob loose with a screwdriver or similar flat tool, and do not attempt to twist the knob from the dial.

b. Observe the position of the setscrew in the bushing, with respect to any panel markings (or at the full ccw position of a continuous control).

c. Release the setscrew and pull the bushing off the shaft.

d. Remove and retain the black nylon thrust washer, behind the dial/knob assembly, as appropriate.

NOTE

To separate the bushing from the knob, if for any reason they should be combined off the instrument, drive a machine tap a turn or two into the bushing for a sufficient grip for easy separation.

6.7 KNOB INSTALLATION.

To install a knob assembly on the control shaft:

- a. Place the black nylon thrust washer over the control shaft, if appropriate.
- b. Mount the bushing on the shaft, using a small slotted piece of wrapping paper as a shim for adequate panel clearance.
- c. Orient the setscrew on the bushing with respect to the panel-marking index and lock the setscrew with the appropriate hex-socket key wrench.

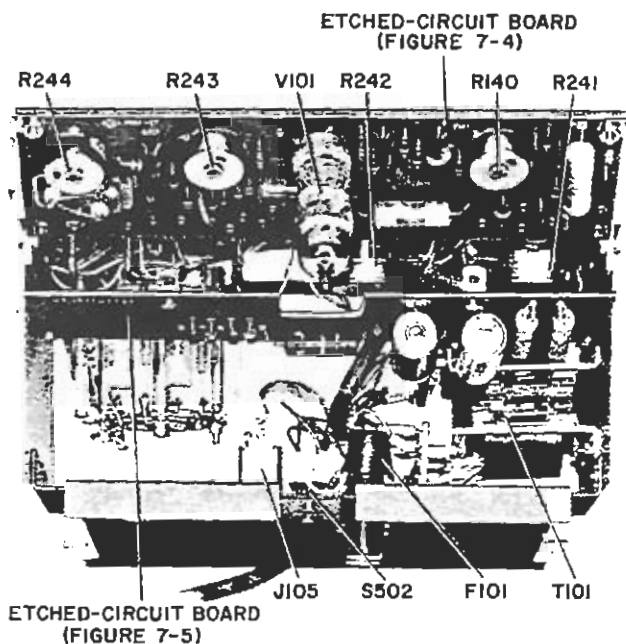

Figure 6-2. Top interior view of 1863 Megohmmeter with both etched-circuit boards tipped up.

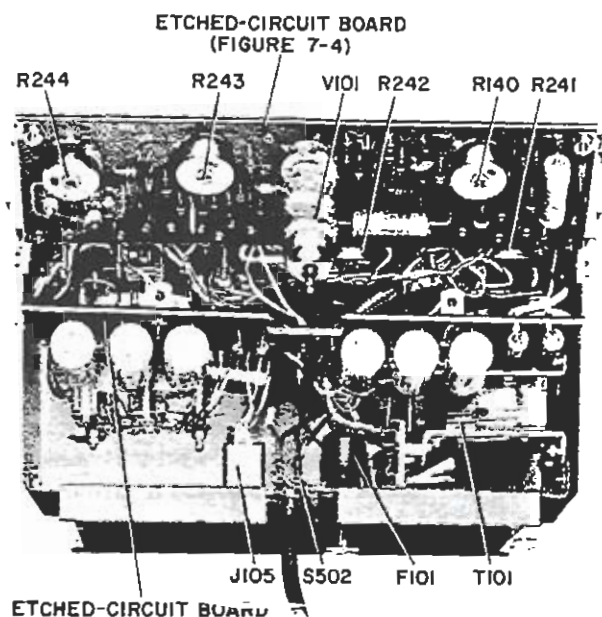

Figure 6-4. Top interior view of 1864 Megohmmeter with both etched-circuit boards tipped up.

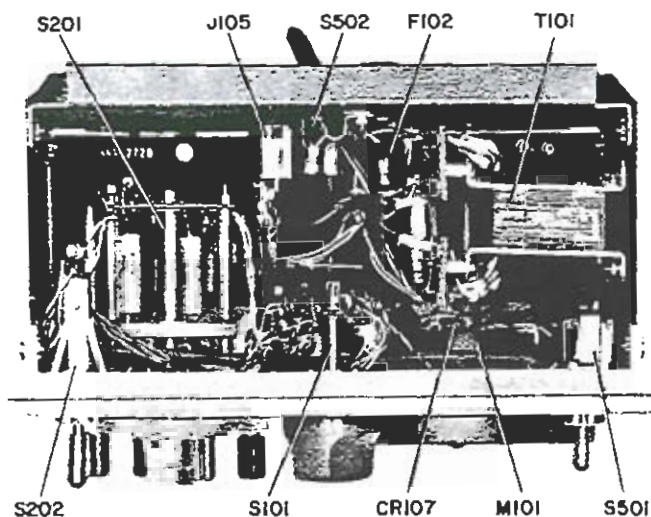

Figure 6-3. Bottom interior view of 1863 Megohmmeter.

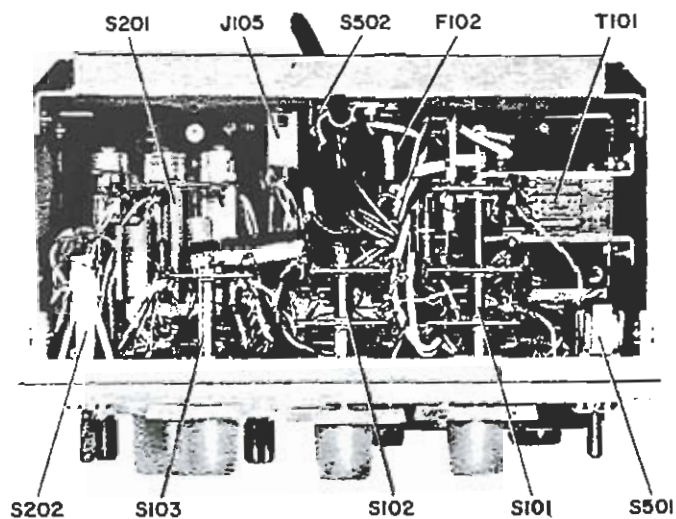

Figure 6-5. Bottom interior view of 1864 Megohmmeter.

NOTE

Make sure that the end of the shaft does not protrude through the bushing or the knob won't bottom properly.

d. Place the knob on the bushing with the retention spring opposite the setscrew.

e. Push the knob in until it bottoms and pull it slightly to check that the retention spring is seated in the groove in the bushing.

NOTE

If the retention spring in the knob comes loose, reinstall it in the interior notch that has the thin slit in the side wall. It will not mount in the other notch.

6.8 METER WINDOW CARE.

The clear acrylic meter window can become susceptible to electrostatic-charge buildup and can be scratched, if improperly cleaned.

It is treated inside and out in manufacturing with a special non-abrasive anti-static solution, Statnul*, which normally should preclude any interference in meter operation caused by electrostatic effects. The problem is evidenced by the inability of the meter movement to return promptly to a zero reading, once it is deenergized. As supplied by GenRad, the meter should return to zero reading within 30 seconds, immediately following the placement of a static charge, as by rubbing the outside surface. This meets the requirements of ANSI standard C39.1-1972.

If static-charge problems occur, possibly as the result of frequent cleaning, the window should be carefully polished with a soft dry cloth, such as cheesecloth or nylon chiffon. Then, a coating of Statnul should be applied with the polishing cloth.

*Available from Mancib Co., Burlington, MA 01803

CAUTION

Do not use any kind of solvent. Kleenex or paper towels can scratch the window surface.

If it should be necessary to place limit marks on the meter window, paper-based masking tape is recommended, rather than any kind of marking pen, which could be abrasive or react chemically with the acrylic.

6.9 ELAPSED-TIME INDICATOR

An elapsed-time indicator is furnished to show the actual total elapsed hours that the instrument has been operated. It is mounted inside the case below the J105 output jack (Figure 6-3) and indicates up to 5000 hours elapsed time. It is a glass capillary tube marked with 10 graduations that read 0 through 5000. Elapsed time is indicated by the height of an electrolytic column in the tube.

The indicator is non-reversible and should be replaced when it gets to full scale reading. It is mounted in a polarized fuse clip for easy removal for viewing or replacement. Polarity is indicated by the size of the electrode at each end.

NOTE

Electrical parts information in this section is presented in such a way that all the data for a part-numbered sub-assembly are visible in a single opening of the manual. Thus, the parts list appears on left-hand pages, while the part-location diagram (on the apron) and the schematic diagram (tip out) are on right-hand pages.

REFERENCE DESIGNATOR ABBREVIATIONS

B	= Motor	P	= Plug
BT	= Battery	Q	= Transistor
C	= Capacitor	R	= Resistor
CR	= Diode	S	= Switch
OS	= Lamp	T	= Transformer
F	= Fuse	U	= Integrated Circuit
J	= Jack	VR	= Diode, Zener
K	= Relay	X	= Socket for Plug-In
KL	= Relay Coil	Y	= Crystal
KS	= Relay Switch	Z	= Network
L	= Inductor		
M	= Meter		
MK	= Microphone		

References
ASA Y32.16 and MIL-STD-16C

Parts Lists and Diagrams—Section 7

ELECTRICAL PARTS LIST

CHASSIS MOUNTED PARTS P/N 1863-3000

REFDES	DESCRIPTION	PART NO.	FMC	MFR	PART NUMBER
C 110	CAP MYLAR .047UF 10 PCT 600V	4860-8021	75042	663UM	.047 UF 10PCT
C 113	CAP CER DISC 6800PF 20PCT 1.4KV	4406-2689	72982	848-25U-6E00PF	20PCT
CR 106	RECT 1N4005 600PIV .75A SI A50A	6081-1003	14433	1N4005	
CR 107	RECT 1N4005 600PIV .75A SI A50A	6081-1003	14433	1N4005	
F 101	FUSE SLC-BLCK 1/8A 250V	5330-0450	75915	313	.125
F 102	FUSE SLC-BLCK 1/16A 250V	5330-0300	75915	313	.062
J 101	BINDING POST ASM	0938-3003	24655	0938-3003	
J 102	BINDING POST ASM	0938-3022	24655	0938-3022	
J 103	BINDING POST ASM	0938-3003	24655	0938-3003	
J 104	BINDING POST ASM	0938-3003	24655	0938-3003	
J 105	PHCNE INS .281L 2 CKT	4260-1031	82389	N-111	
M 101	METER	5730-1412	24655	5730-1412	
P 101	LAMP FLANGE BASE 6V 0.2A 1000H	5600-0300	71744	CM-328	
P 102	LAMP FLANGE BASE 6V 0.2A 1000H	5600-0300	71744	CM-328	
P 103	LAMP FLANGE BASE 6V .04A 10000H	5600-0316	71744	CM-345	
PL 501	CORD 3WR 10A 120V US 7FT HAMMER	4200-1800	24655	4200-1800	
R 124	RES FLM 249K 1/2 PCT 1/4W	6351-3249	81349	RN60D2493C	
R 125	RES FLM 499K 1/2 PCT 1/4W	6351-3499	81349	RN60D4993D	
R 126	RES FLM 249K 1/2 PCT 1/4W	6351-3249	81349	RN60D2493C	
R 127	RES FLM 1.24M 1/2 PCT 1/2W	6451-4124	81349	RN65D1244C	
R 137	RES COMP 1M OHM 5PCT 1/2W	6100-0115	81349	RCR20G110J	
R 211	RES FLM 10.0K 1 PCT 1/8W	6250-2100	81349	RN55D1002F	
R 212	RES FLM 1.1K 1 PCT 1/8W	6250-1110	81349	RN55D1101F	
R 213	RES FLM 102K 1 PCT 1/8W	6250-3102	81349	RN55D1023F	
R 214	RES FLM 2K 1/2PCT 1/8W	6251-1200	81349	RN55D2001D	
R 215	RES FLM 20K 1 PCT 1/2W	6450-2200	81349	RN65D2002F	
R 216	RES FLM 200K 1 PCT 1W	6550-3200	81349	RN75D2003F	
R 217	RES FLM 2M 1 PCT 1/2W	6450-4200	81349	RN65D2004F	
R 218	RES FLM 20M 1 PCT 1W	6550-5200	81349	RN75D2005F	
R 219	RES FLM 200M 1PCT 100PPM 1W	6619-3407	24655	6619-3407	
R 220	RES FLM 3.01M 2PCT HV200PPM 1/2W	6619-3409	24655	6619-3409	
R 221	RES FLM 1K 1 PCT 1/8W	6250-1100	81349	RN55D1001F	
R 222	RES FLM 4.99K 1 PCT 1/8W	6250-1499	81349	RN55D4991F	
R 223	RES FLM 10.0K 1 PCT 1/8W	6250-2100	81349	RN55D1002F	
R 224	RES COMP 240 K OHM 5PCT 1/4W	6099-4245	81349	RCR07G244J	
R 241	POT COMP KNOB 100 OHM 10 PCT LIN	6000-0050	01121	JAIN056S101GZ	
R 242	POT COMP KNOB 2.5K OHM 10PCT LIN	6000-0400	01121	JAIN056S252GZ	
R 245	RES W W AX LEAD 5.1K OHM 5PCT 3W	6680-2515	75042	AS-2 5.1 K 5PCT	
R 247	RES FILM 1 M OHM ± 1%	6250-4100			
R 248	RES FILM 632K OHM ± 1%	6250-3432			
S 101	SWITCH RCTARY ASM	7890-5390	24655	7890-5390	
S 201	SWITCH RCTARY ASM	7890-5400	24655	7890-5400	
S 202	SWITCH ASM	1864-1400	24655	1864-1400	
S 501	SWITCH TOGGLE 2PCS DPST STEADY	7910-1300	04009	83053	
S 502	SWITCH SLIDE 2 PCS DPST STEADY	7910-0832	82389	11A-1266	
T 101	TRANSFORMER POWER	0345-4029	24655	0345-4029	
V 101	TUBE VACUUM 6AB4	8360-0100	79089	6AB4	
	ELAPSED TIME INDICATOR	1644-0440		T-0004	
	ELAPSED TIME INDICATOR HOLDER	1644-0441		T-103	

ELECTRICAL PARTS LIST

CHASSIS MOUNTED PARTS P/N 1864-3000

REFCES	DESCRIPTION	PART NO.	FMC	MFGR	PART NUMBER
C 110	CAP MYLAR .047UF 10 PCT 1000V	4860-8255	75042	6630W	.047 UF 10PCT
C 111	CAP CER SQ .10UF 80/20PCT 100V	4403-4100	72982	8131M1306511042	
C 113	CAP CER DISC 6800PF 20PCT 1.4KV	4406-2689	72982	848-25U-6800PF20PCT	
CR 106	RECT 1N4005 60CPIV .75A SI A50A	6081-1003	14433	1N4005	
CR 107	RECT 1N4005 60CPIV .75A SI A50A	6081-1003	14433	1N4005	
CR 108	DIODE RECTIFIER 1N4003	6081-1001	14433	1N4003	
F 101	FUSE SLC-BLOW 1/8A 250V	5330-0450	75915	313	.125
F 102	FUSE SLC-BLOW 1/16A 250V	5330-0300	75915	313	.062
J 101	BINDING POST ASM	0938-3003	24655	0938-3003	
J 102	BINDING POST ASM	0938-3022	24655	0938-3022	
J 103	BINDING POST ASM	0938-3003	24655	0938-3003	
J 104	BINDING POST ASM	0938-3003	24655	0938-3003	
J 105	PHCNE INS .281L 2 CKT	4260-1031	82389	N-111	
M 101	METER	5730-1412	24655	5730-1412	
P 101	LAMP FLANGE BASE 6V 0.2A 1000H	5600-0300	71744	CM-328	
P 102	LAMP FLANGE BASE 6V 0.2A 1000H	5600-0300	71744	CM-328	
P 103	LAMP FLANGE BASE 6V .04A 10000H	5600-0216	71744	CM-345	
PL 501	CORD 3WR 10A 120V US 7FT HAMMER	4200-1800	24655	4200-1800	
R 109	RES COMP 62 K 5PCT 1W	6110-3625	81349	RCR32G623J	
R 110	RES COMP 68 K 5PCT 1W	6110-3685	81349	RCR32G683J	
R 111	RES COMP 270 K 5PCT 1W	6110-4275	81349	RCR32G274J	
R 112	RES COMP 120 K 5PCT 1/2W	6100-4125	81349	RCR20G124J	
R 113	RES COMP 350 K 5PCT 1/2W	6100-4355	81349	RCR20G394J	
R 114	RES COMP 1.2 M 5PCT 1/2W	6100-5125	81349	RCR20G125J	
R 115	RES COMP 39 K 5PCT 1W	6110-3395	81349	RCR32G393J	
R 116	RES COMP 47 K 5PCT 2W	6120-3475	81349	RCR42G473J	
R 124	RES FLM 226K 1/2PCT 1/8W	6251-3226	81349	RN55D2263C	
R 125	RES COMP 30 K CHM 5PCT 1/2W	6100-3305	81349	RCR20G303J	
R 126	RES FLM 499K 1/2 PCT 1/4W	6351-3499	81349	RN6004993D	
R 127	RES FLM 1M 1/2 PCT 1/2W	6451-4100	81349	RN65D1004C	
R 128	RES FLM 2M 1/2 PCT 1/2W	6451-4200	81349	RN65D2004C	
R 129	RES FLM 2M 1/2 PCT 1/2W	6451-4200	81349	RN65D2004C	
R 130	RES FLM 49.9K 1/2 PCT 1/4W	6351-2499	81349	RN60D4992D	
R 131	RES FLM 100K 1 PCT 1/4W	6350-3100	81349	RN60D1003F	
R 132	RES FLM 200K 1 PCT 1/4W	6350-3200	81349	RN60D2003F	
R 133	RES FLM 200K 1 PCT 1/4W	6350-3200	81349	RN60D2003F	
R 137	RES COMP 11 CHM 5PCT 1/2W	6100-0115	81349	RCR20G110J	
R 141	RES COMP 30 K CHM 5PCT 1/4W	6099-3305	81349	RCR07G303J	
R 211	RES FLM 100K 1 PCT 1/8W	6250-3100	81349	RN55D1003F	
R 212	RES FLM 11K 1 PCT 1/8W	6250-2110	81349	RN55D1102F	
R 213	RES FLM 1.02M 1 PCT 1/2W	6450-4102	81349	RN65D1024F	
R 214	RES FLM 2K 1/2PCT 1/8W	6251-1200	81349	RN55D2001D	
R 215	RES FLM 20K 1 PCT 1/2W	6450-2200	81349	RN65D2002F	
R 216	RES FLM 200K 1 PCT 1W	6550-3200	81349	RN75D2003F	
R 217	RES FLM 2M 1 PCT 1/2W	6450-4200	81349	RN65D2004F	
R 218	RES FLM 20M 1 PCT 1W	6550-5200	81349	RN75D2005F	
F 219	RES FLM 200M 1PCT 100PPM 1W	6619-3407	24655	6619-3407	
R 220	RES FILM CARBON 2G OHM 1 PCT	6740-1504	63060	RX-1	
R 221	RES COMP 47 M 5PCT 1/4W	6099-6475	81349	RCR07G476J	
F 221	RES FLM 1.91K 1/2 PCT 1/4W	6351-1191	81349	RN60D1911C	
R 222	RES FLM 3.01M 2PCT HV200PPM 1/2W	6619-3409	24655	6619-3409	
R 222	RES FLM 3.83K 1/2 PCT 1/4W	6351-1383	81349	RN60D3831C	
R 223	RES FLM 7.68K 1/2 PCT 1/4W	6351-1768	81349	RN60D7681D	
R 224	RES FLM 7.68K 1/2 PCT 1/4W	6351-1768	81349	RN60D7681C	
R 225	RES FLM 191 CHM 1 PCT 1/8W	6250-0191	81349	RN55D1910F	
R 226	RES FLM 383 OHM 1 PCT 1/8W	6250-0383	81349	RN55D3830F	
R 227	RES FLM 768 CHM 1 PCT 1/8W	6250-0768	81349	RN55D7680F	
R 228	RES FLM 768 OHM 1 PCT 1/8W	6250-0768	81349	RN55D7680F	
R 241	POT COMP KNOB 1K OHM 10 PCT LIN	6000-0300	01121	JAIN056S102LZ	
R 242	POT COMP KNOB 2.5K OHM 10PCT LIN	6000-0400	01121	JAIN056S252LZ	
R 245	RES WW AX LEAD 5.1K CHM 5PCT 3W	6680-2515	75042	AS-2 5.1 K 5PCT	
S 101	SWITCH RCTARY ASM	7890-5350	24655	7890-5350	
S 102	SWITCH RCTARY ASM	7890-5360	24655	7890-5360	
S 103	SWITCH RCTARY ASM	7890-5370	24655	7890-5370	
S 201	SWITCH RCTARY ASM	7890-5380	24655	7890-5380	
S 202	SWITCH ASM	1864-0400	24655	1864-0400	
S 501	SWITCH TOGGLE 2PCS DPST STEADY	7910-1300	04009	83053	
S 502	SWITCH SLIDE 2 PGS DPST STEADY	7510-0832	82389	11A-1266	
T 101	TRANSFORMER FCWER	0345-4028	24655	0345-4028	
V 101	TUBE VACUUM 6AB4	E360-0100	75089	6AB4	

ELECTRICAL PARTS LIST

REGULATOR & AMPLIFIER PC BOARD P/N 1864-2701

REFDES	DESCRIPTION	PART NO.	FMC	MFR	PART NUMBER
C 107	CAP ALUM 30 UF 75V	4450-6173	56289	43D300G075	
C 108	CAP CER DISC .01UF 80/20PCT 100V	4401-3100	72982	030554025000103Z	
C 109	CAP CER DISC 100PF 5PCT 500V	4404-1105	72982	03108225000101J	
C 201	CAP ALUM 30 UF 75V	4450-6173	56289	43D300G075	
C 202	CAP CER DISC .01UF 80/20PCT 100V	4401-3100	72982	030554025000103Z	
C 203	CAP MICA 100PF 5PCT 500V	4680-1500	81349	CM20CD101J	
CR 105	DIODE RECTIFIER 1N4003	6081-1001	14433	1N4003	
CR 111	ZENER 1N9708 24V 5PCT .4W	6083-1054	14433	1N9708	
CR 112	ZENER 1A825 6.2V 5PCT .4W	6083-1060	03877	1N825	
CR 201	DIODE RECTIFIER 1N4003	6081-1001	14433	1N4003	
CR 211	ZENER 1A9688 20V 5PCT .4W	6083-1018	14433	1A9688	
CR 212	ZENER 1N9658 15V 5PCT .4W	6083-1015	14433	1N9658	
C 101	TRANSISTOR 2N3903	8210-1132	04713	2N3903	
C 102	TRANSISTOR 2N4250	8210-1294	07263	2N4250	
C 103	TRANSISTOR 2N4250	8210-1294	07263	2N4250	
C 201	TRANSISTOR 2N3903	8210-1132	04713	2N3903	
C 202	TRANSISTOR 2N3905	8210-1114	04713	2N3905	
C 203	TRANSISTOR 2N3905	8210-1114	04713	2N3905	
Q 204	TRANSISTOR (STATIC PROTECT REQ)	8210-1143	04713	2N4220	
Q 205	TRANSISTOR MPS-A14	8210-1246	04713	MPS-A14	
C 206	TRANSISTOR 2N3414	8210-1290	56289	2N3414	
R 107	RES COMP 2.0 K CHM 5PCT 1/2W	6100-2205	81349	RCR20G202J	
R 108	RES COMP 1.0 K 5PCT 1/2W	6100-2105	81349	RCR20G102J	
R 117	RES COMP 220 CHM 5PCT 1/2W	6100-1225	81349	RCR20G221J	
R 118	RES COMP 200 K CHM 5PCT 1/2W	6100-4205	81349	RCR20G204J	
R 119	RES COMP 12 K 5PCT 1/2W	6100-3125	81349	RCR20G123J	
R 120	RES COMP 3.3 K 5PCT 1/2W	6100-2335	81349	RCR20G332J	
R 121	RES COMP 10 K 5PCT 1/2W	6100-3105	81349	RCR20G103J	
R 122	RES COMP 10 K 5PCT 1/2W	6100-3105	81349	RCR20G103J	
R 123	RES FLM 24.9K 1/2PCT 1/8W	6251-2249	81349	RN5502492D	
R 134	RES COMP 68 K 5PCT 1/2W	6100-3685	81349	KCR20G683J	
R 135	RES COMP 16 K CHM 5PCT 1/2W	6100-3165	81349	RCR20G163J	
F 138	RES COMP 22 K 5PCT 1/2W	6100-3225	81349	RCR20G223J	
R 139	RES FLM 200K 1 PCT 1/4W	6350-3200	81349	RN60D2003F	
R 140	POT WW TRM 5K CHM 10 PCT 1T	6056-0142	24655	6056-0142	
R 201	RES COMP 1.2 K 5PCT 1/2W	6100-2125	81349	RCR20G122J	
R 202	RES COMP 2.7 K 5PCT 1/2W	6100-2275	81349	RCR20G272J	
R 203	RES COMP 27 K 5PCT 1/2W	6100-3275	81349	RCR20G273J	
R 204	RES COMP 43 K CHM 5PCT 1/2W	6100-3435	81349	KCR20G433J	
R 205	RES COMP 3.3 K 5PCT 1/2W	6100-2335	81349	RCR20G332J	
R 206	RES COMP 10 K 5PCT 1/2W	6100-3105	81349	RCR20G103J	
R 207	RES COMP 24 K CHM 5PCT 1/2W	6100-3245	81349	KCR20G243J	
R 208	RES COMP 20 K CHM 5PCT 1/2W	6100-3205	81349	RCR20G203J	
R 209	RES COMP 47 M 5PCT 1/2W	6100-6475	81349	RCR20G476J	
R 210	RES COMP 47 M 5PCT 1/2W	6100-6475	81349	RCR20G476J	
R 229	RES COMP 1.2 K 5PCT 1/2W	6100-2125	81349	RCR20G122J	
R 230	RES COMP 100 K 5PCT 1/2W	6100-4105	81349	RCR20G104J	
R 231	RES COMP 1.0 M 5PCT 1/2W	6100-5105	81349	RCR20G105J	
R 232	RES COMP 10 M 5PCT 1/2W	6100-6105	81349	RCR20G106J	
R 234	RES COMP 10 K 5PCT 1/4W	6099-3105	81349	RCR07G103J	
R 235	RES COMP 100 CHM 5PCT 1/4W	6099-1105	81349	RCR07G101J	
R 236	RES COMP 2.4 M CHM 5PCT 1/2W	6100-5245	81349	RCR20G245J	
R 237	RES COMP 2.4 M CHM 5PCT 1/2W	6100-5245	81349	RCR20G245J	
R 238	RES COMP 2.4 M CHM 5PCT 1/2W	6100-5245	81349	RCR20G245J	
R 239	RES COMP 2.4 M CHM 5PCT 1/2W	6100-5245	81349	RCR20G245J	
R 243	POT WW TRM 500 CHM 10 PCT 1T	6056-0136	24655	6056-0136	
R 244	POT WW TRM 5K CHM 10 PCT 1T	6056-0142	24655	6056-0142	
V 101	TUBE VACUUM 6AB4	8360-0100	79089	6AB4	

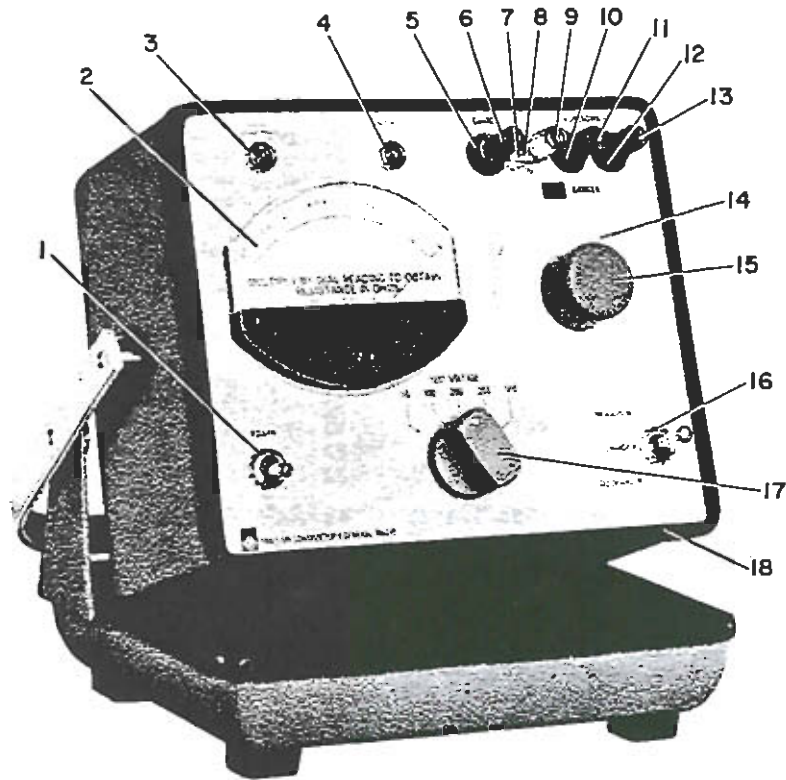

Figure 7-1. Replaceable mechanical parts on the 1863 (portable unit shown).

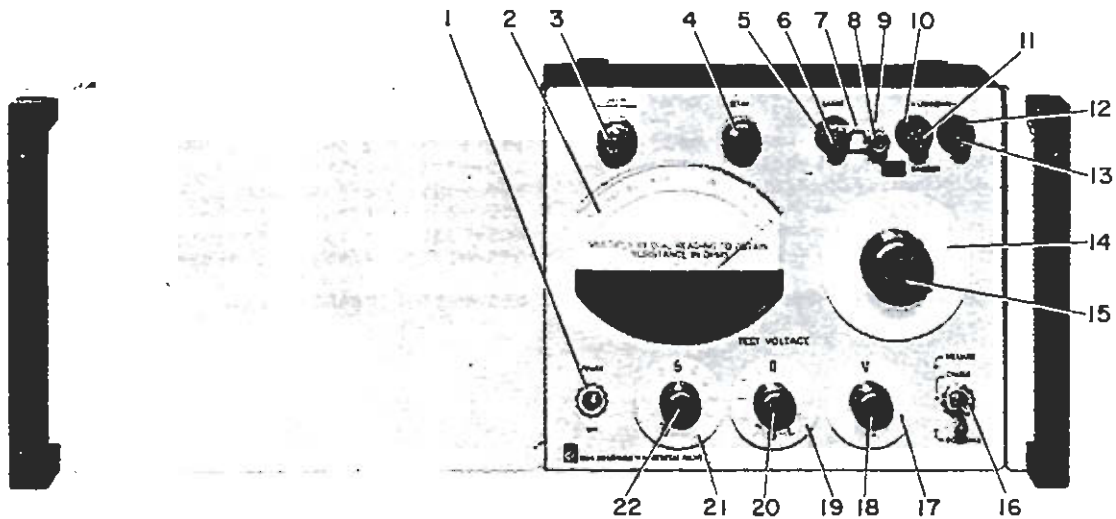
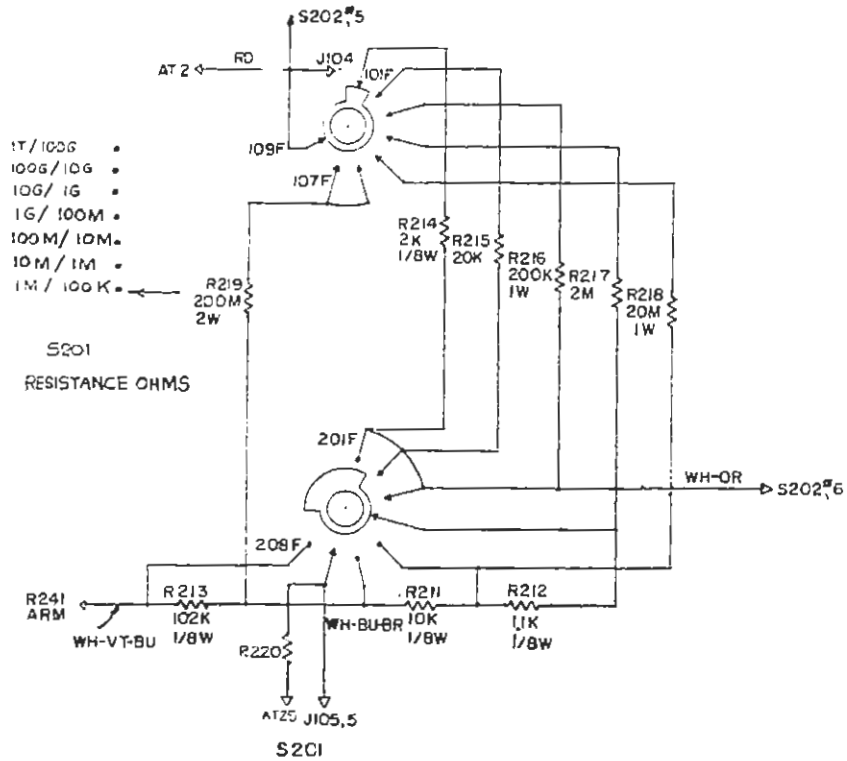

Figure 7-2. Replaceable mechanical parts on the 1864 (rack-mount unit shown).

MECHANICAL PARTS LIST

Reference Number		Name	Description	GR Part No.	Fed. Mfg. Part No.	Fed. Stock No.
Fig. 7-1	Fig. 7-2				Mfg. Code	
1	1	DRESS NUT	Nut, 15/32 -32, 7/16 inch.	5800-0800	24655 5800-0800	5310-344-3634
2	2	METER COVER	Weston, 4 inch, light gray.	5720-4711	24655 5720-4711	
3,4	—	DRESS NUT	Nut, 3/8 -32, 7/16 inch.	5800-0805	24655 5800-0805	
—	3,4	KNOB ASM.	Knob, white dot and line including retainer P/N 5220-5402.	5520-5221	24655 5520-5221	
5,10,12	5,10,12	INSULATOR	Gray insulator.	0938-9813	24655 0938-9813	
6,11,13	6,11,13	BINDING POST ASM.	Red-top. Binding Post, Brass	0938-9734	24655 0938-9734	
7	7	SHORTING LINK	Shorting link.	5080-4800	24655 5080-4800	5940-927-7452
9	8	BINDING POST ASM.	Jack with top and shaft	0938-3022	24655 0938-3022	
8	9	SPACER	Spacer to ground jack to panel.	0938-9706	24655 0938-9706	
14"	14	DIAL ASM.	Range switch dial assembly including bushing P/N 4143-3251.	1864-1200	24655 1864-1200	
15	15	KNOB	Range switch knob including retainer P/N 5220-5401.	5520-5420	24655 5520-5420	
16	16	DRESS NUT	Nut, 15/32 -32, 1/2 inch.	5800-0810	24655 5800-0810	5310-991-7185
—	17	DIAL ASM.	Right-hand TEST VOLTAGE dial assembly including bushing P/N 4143-3241.	1864-1220	24655 1864-1220	
17	—	KNOB ASM.	Knob, TEST VOLTAGE, including retainer P/N 5520-5401.	5500-5421	24655 5500-5421	
—	18,20,22	KNOB	Knob, no lines, including retainer P/N 5220-5402.	5520-5220	24655 5520-5220	
—	19	DIAL ASM.	Center TEST VOLTAGE dial assembly including bushing P/N 4143-3241.	1864-1230	24655 1864-1230	
—	21	DIAL ASM.	Left-hand TEST VOLTAGE dial assembly including bushing P/N 4143-3241.	1864-1210	24655 1864-1210	
18	—	GASKET	Rubber gasket around panel.	5331-3602	24655 5331-3602	
Rear Panel	Rear Panel	FUSEHOLDER	(Removed on rack-mount unit) Fuse Mounting Device	5650-0100	71400 HKP-H	5920-284-7144

*P/N 1863-1200 on 1863



Rotary switch sections are shown as viewed from the panel end of the shaft. The first digit of the contact number refers to the section. The section nearest the panel is 1, the next section back is 2, etc. The next two digits refer to the contact. Contact 01 is the first position clockwise from a strut screw (usually the screw above the locating key), and the other contacts are numbered sequentially (02, 03, 04, etc), proceeding clockwise around the section. A suffix F or R indicates that the contact is on the front or rear of the section, respectively.

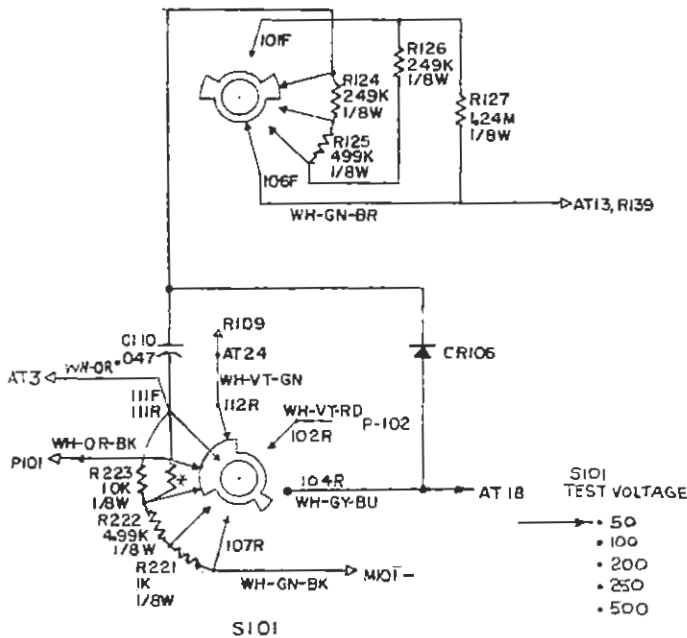

NOTE: R224, 240 kΩ nominal added across R223.

Figure 7-3. Type 1863 switching diagram.

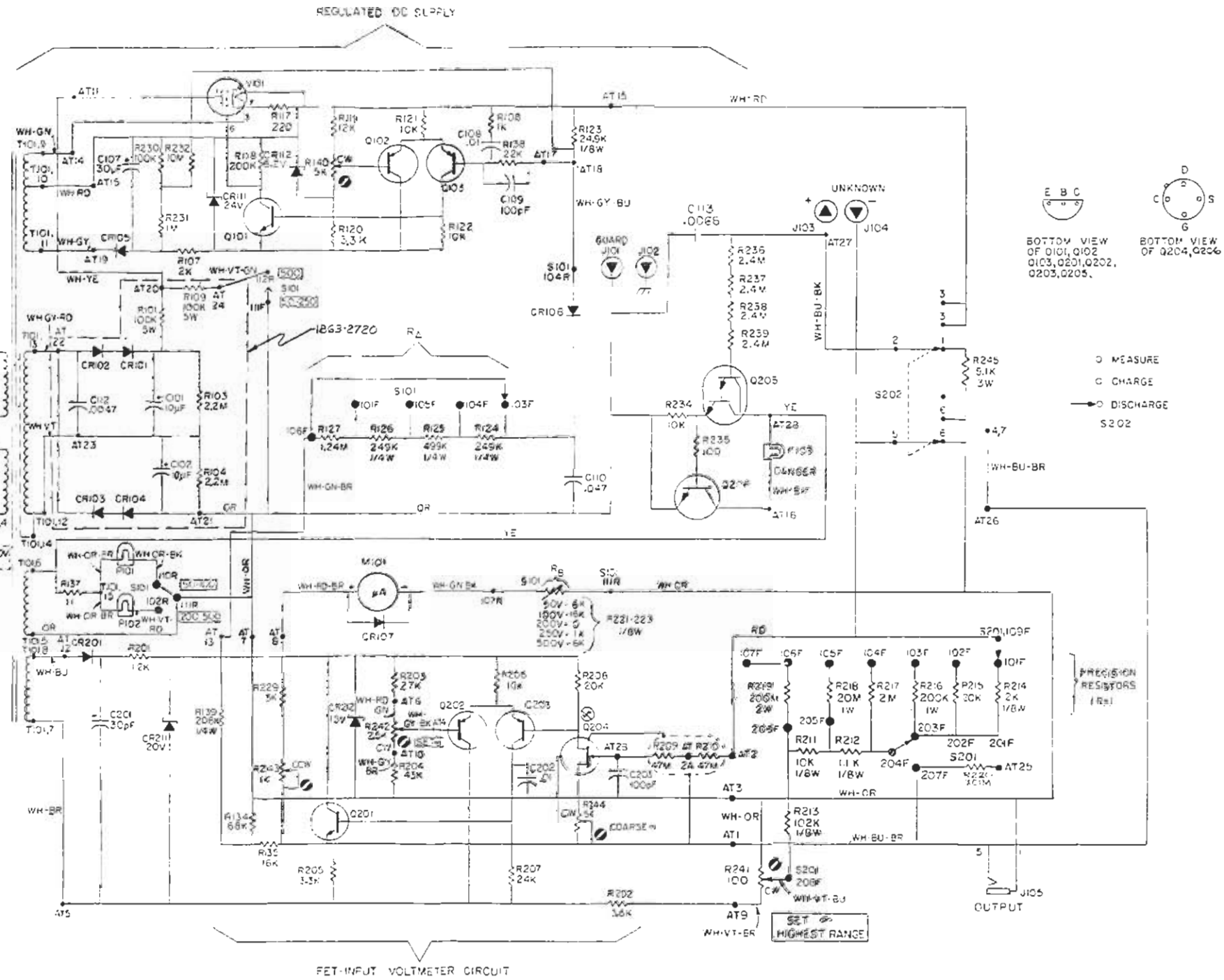
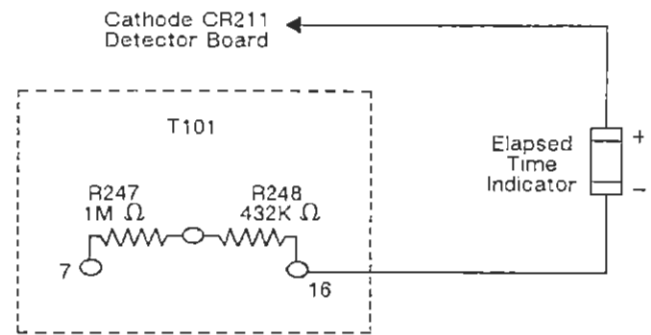

CAUTION ⚡
 THE FOLLOWING COMPONENTS
 REQUIRE SPECIAL HANDLING
 FOR STATIC PROTECTION
 REFER TO CSMA-SH01-P1
 Q204

- ANCHOR TERMINALS USED AT 1, 2, 24, 25, 26, 28 THRU 29
- NOTE UNLESS SPECIFIED
- | | |
|---|---|
| 1. POSITION OF ROTARY SWITCHES SHOWN COUNTERCLOCKWISE | 5. RESISTANCE IN OHMS & 1000 OHMS & 1 MEGOHM |
| 2. CONTACT NUMBERING OF SWITCHES EXPLAINED ON SEPARATE SHEET SUPPLIED IN INSTRUCTION BOOK | 6. CAPACITANCE VALUES ONE AND OVER IN MICROFARADS, LESS THAN ONE IN MICROFARADS |
| 3. REFER TO SERVICE NOTES IN INSTRUCTION BOOK FOR VOLTAGES APPEARING ON DIAGRAM | 7. KNOB CONTROL |
| 4. RESISTORS 1/2 WATT | 8. SCREWDRIVER CONTROL |
| | 9. AT ANCHOR TERMINAL |
| | 10. TP TEST POINT |

Figure 7-6. Type 1863 schematic diagram.

Rotary switch sections are shown as viewed from the panel end of the shaft. The first digit of the contact number refers to the section. The section nearest the panel is 1, the next section back is 2, etc. The next two digits refer to the contact. Contact 01 is the first position clockwise from a strut screw (usually the screw above the locating key), and the other contacts are numbered sequentially (02, 03, 04, etc), proceeding clockwise around the section. A suffix F or R indicates that the contact is on the front or rear of the section, respectively.

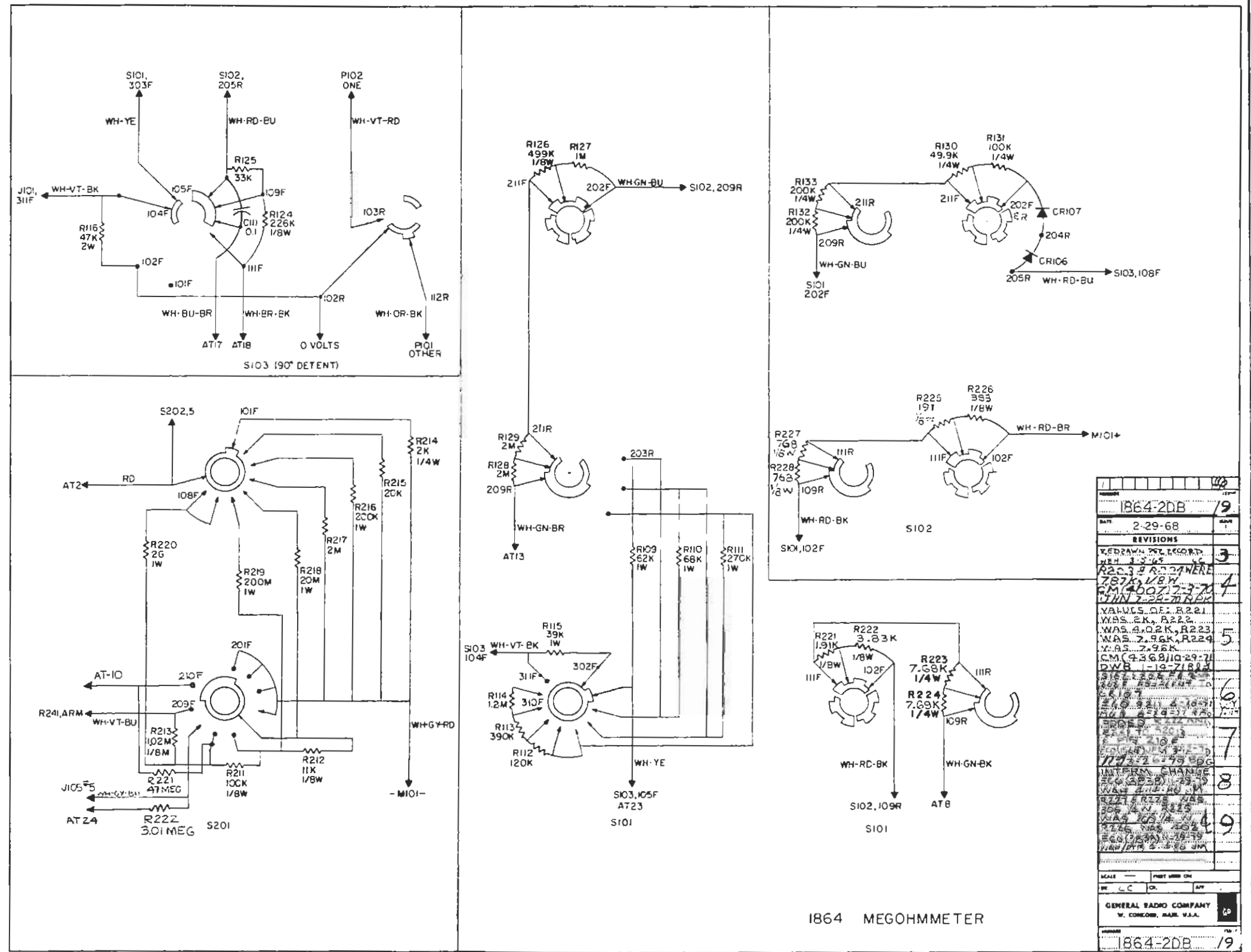
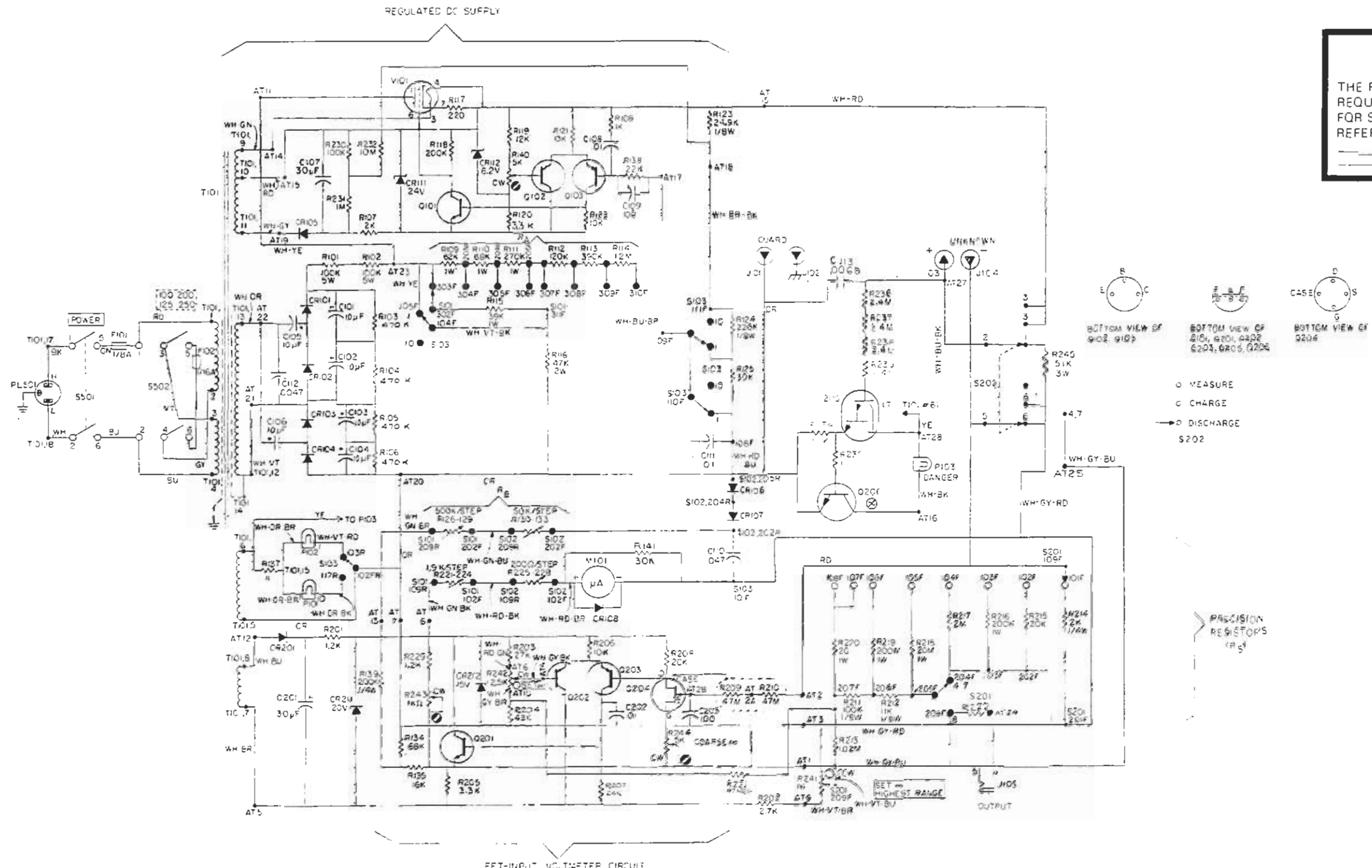

Figure 7-7. Type 1864 switching diagram.



CAUTION ⚡
 THE FOLLOWING COMPONENTS
 REQUIRE SPECIAL HANDLING
 FOR STATIC PROTECTION
 REFER TO CSMA-SHO1-P1
 Q204

- ANCHOR TERMINALS USED AT 1,2,4,26,3 THRU 25,27,28
 NOTE UNLESS SPECIFIED
- | | |
|---|--|
| 1 POSITION OF ROTARY SWITCHES SHOWN COUNTERCLOCKWISE. | 5 RESISTANCE IN OHMS
K - 1000 OHMS M - 1 MEGOHM
OVER IN MICROFARADS LESS THAN ONE IN MICROFARADS |
| 2 CONTACT NUMBERING OF SWITCHES EXPLAINED ON SEPARATE SHEET SUPPLIED IN INSTRUCTION BOOK. | 6 CAPACITANCE VALUES ONE AND OVER IN MICROFARADS LESS THAN ONE IN MICROFARADS |
| 3 REFER TO SERVICE NOTES IN INSTRUCTION BOOK FOR VOLTAGES APPEARING IN DIAGRAM | 7 KNOB CONTROL |
| 4 RESISTORS 1/2 WATT. | 8 SCREWDRIVER CONTROL |
| | 9 AT ANCHOR TERMINAL |
| | RD TP - TEST POINT |

* FACTORY SELECTED

Figure 7-9. Type 1864 schematic diagram.

ELECTRICAL PARTS LIST

REGULATOR & AMPLIFIER PC BOARD P/N 1864-2711

REFDES	DESCRIPTION	PART NO.	FMC	MFR	PART NUMBER
C 107	CAP ALUM 30 UF 75V	4450-6173	56289	43030G075	
C 108	CAP CER DISC .01UF 80/20PCT 100V	4401-3100	72982	080554025000103Z	
C 109	CAP CER DISC 100PF 5PCT 500V	4404-1105	72982	083108225000101J	
C 201	CAP ALUM 30 UF 75V	4450-6173	56289	43030G075	
C 202	CAP CER DISC .01UF 80/20PCT 100V	4401-3100	72982	080554025000103Z	
C 203	CAP MICA 100 PF 5PCT 500V	4700-0660	81349	CM05F3101JN	
CR 105	DIODE RECTIFIER 1N4003	6081-1301	14433	1N4003	
CR 111	ZENER 1N970B 24V 5PCT .4W	6083-1054	14433	1N970B	
CR 112	ZENER 1N825 5.2V 5PCT .4W	6083-1260	03877	1N825	
CR 201	DIODE RECTIFIER 1N4003	6081-1301	14433	1N4003	
CR 211	ZENER 1N968B 20V 5PCT .4W	6083-1018	14433	1N968B	
CR 212	ZENER 1N965B 15V 5PCT .4W	6083-1015	14433	1N965B	
C 101	TRANSISTOR 2N3903	8210-1132	04713	2N3903	
C 102	TRANSISTOR 2N3905	8210-1114	04713	2N3905	
C 103	TRANSISTOR 2N3905	8210-1114	04713	2N3905	
C 201	TRANSISTOR 2N3903	8210-1132	04713	2N3903	
C 202	TRANSISTOR 2N3905	8210-1114	04713	2N3905	
C 203	TRANSISTOR 2N3905	8210-1114	04713	2N3905	
C 204	TRANSISTOR (STATIC PROTECT REQ)	8210-1142	04713	2N4220	
C 205	TRANSISTOR MPS-A14	8210-1246	04713	MPS-A14	
C 206	TRANSISTOR 2N3414	8210-1290	56289	2N3414	
R 107	RES COMP 2.0 K CHM 5PCT 1/2W	6100-2205	81349	RCR20G202J	
R 108	RES COMP 1.0 K 5PCT 1/2W	6100-2105	81349	RCR20G102J	
R 117	RES COMP 220 OHM 5PCT 1/2W	6100-1225	81349	RCR20G221J	
R 118	RES COMP 220 K CHM 5PCT 1/2W	6100-4205	81349	RCR20G204J	
R 119	RES COMP 12 K 5PCT 1/2W	6100-3125	81349	RCR20G123J	
R 120	RES COMP 3.3 K 5PCT 1/2W	6100-2235	81349	RCR20G322J	
R 121	RES COMP 10 K 5PCT 1/2W	6100-3105	81349	RCR20G103J	
R 122	RES COMP 10 K 5PCT 1/2W	6100-3105	81349	RCR20G103J	
R 123	RES FLM 24.9K 1/2PCT 1/8W	6251-2249	81349	RN5502492D	
R 134	RES COMP 68 K 5PCT 1/2W	6100-3685	81349	RCR20G683J	
R 135	RES COMP 16 K CHM 5PCT 1/2W	6100-3165	81349	RCR20G163J	
R 138	RES COMP 22 K 5PCT 1/2W	6100-3225	81349	RCR20G223J	
R 139	RES FLM 208K 1/2 PCT 1/4W	6351-3208	81349	RN6002083C	
R 140	POT WW TRM 5K CHM 10 PCT 1T	6056-0142	24655	6056-0142	
R 201	RES COMP 1.2 K 5PCT 1/2W	6100-2125	81349	RCR20G122J	
R 202	RES COMP 3.6 K CHM 5PCT 1/2W	6100-2365	81349	RCR20G362J	
R 203	RES COMP 27 K 5PCT 1/2W	6100-3275	81349	RCR20G273J	
R 204	RES COMP 43 K CHM 5PCT 1/2W	6100-3435	81349	RCR20G433J	
R 205	RES COMP 3.3 K 5PCT 1/2W	6100-2335	81349	RCR20G332J	
R 206	RES COMP 10 K 5PCT 1/2W	6100-3105	81349	RCR20G103J	
R 207	RES COMP 24 K CHM 5PCT 1/2W	6100-3245	81349	RCR20G243J	
R 208	RES COMP 20 K CHM 5PCT 1/2W	6100-3205	81349	RCR20G203J	
R 209	RES COMP 47 M 5PCT 1/2W	6100-6475	81349	RCR20G476J	
R 210	RES COMP 47 M 5PCT 1/2W	6100-6475	81349	RCR20G476J	
R 229	RES COMP 3.0 K CHM 5PCT 1/2W	6100-2305	81349	RCR20G302J	
R 230	RES COMP 100 K 5PCT 1/2W	6100-4105	81349	RCR20G104J	
R 231	RES COMP 1.0 M 5PCT 1/2W	6100-5105	81349	RCR20G105J	
R 232	RES COMP 10 M 5PCT 1/2W	6100-6105	81349	RCR20G106J	
R 234	RES COMP 10 K 5PCT 1/4W	6099-3105	81349	RCR07G103J	
R 235	RES COMP 100 CHM 5PCT 1/4W	6099-1105	81349	RCR07G101J	
R 236	RES COMP 2.4 M CHM 5PCT 1/2W	6100-5245	81349	RCR20G245J	
R 237	RES COMP 2.4 M CHM 5PCT 1/2W	6100-5245	81349	RCR20G245J	
R 238	RES COMP 2.4 M CHM 5PCT 1/2W	6100-5245	81349	RCR20G245J	
R 239	RES COMP 2.4 M CHM 5PCT 1/2W	6100-5245	81349	RCR20G245J	
R 243	POT WW TRM 1K CHM 10 PCT 1T	6056-0138	24655	6056-0138	
R 244	POT WW TRM 5K CHM 10 PCT 1T	6056-0142	24655	6056-0142	

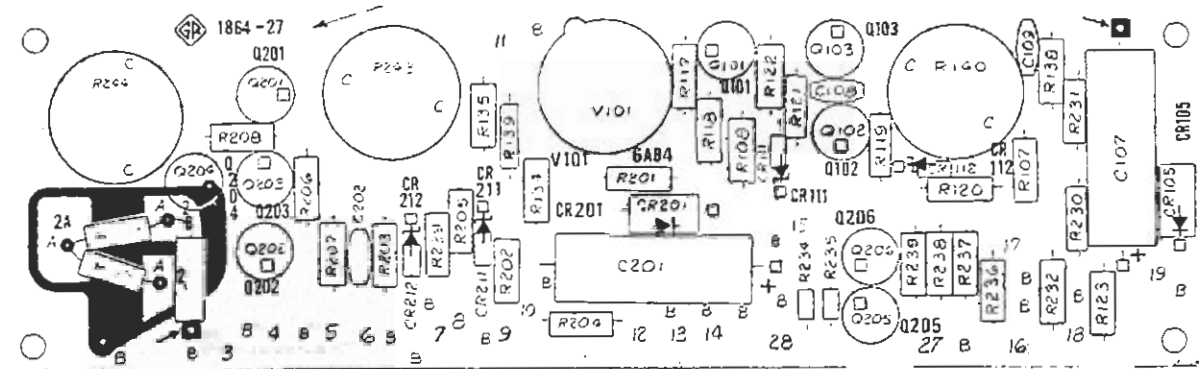

Figure 7-4. Regulator and amplifier circuits etched-board assembly for 1863 and 1864.

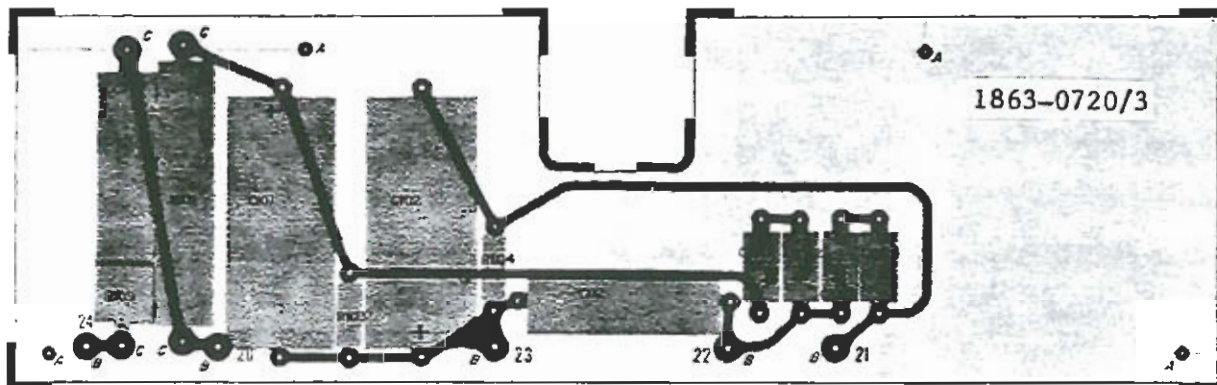

Figure 7-5. Type 1863 rectifier circuit etched-board assembly (P/N 1863-2720).

ELECTRICAL PARTS LIST

RECTIFIER PC BOARD		P/N 1863-2720				
REFDES	DESCRIPTION	PART NO.	FMC	MFR	PART	NUMBER
C 101	CAP ALUM 10UF 475V	4450-6175	90201	TCG	10UF	475V
C 102	CAP ALUM 10UF 475V	4450-6175	90201	TCG	10UF	475V
C 112	CAP POLYPROPYLENE 4.7NF 10% 1.6KV	4863-4341	80183	715P472916LA3		
CR 101	RECT IN4005 600PIV .75A SI A50A	6081-1003	14433	IN4005		
CR 102	RECT IN4005 600PIV .75A SI A50A	6081-1003	14433	IN4005		
CR 103	RECT IN4005 600PIV .75A SI A50A	6081-1003	14433	IN4005		
CR 104	RECT IN4005 600PIV .75A SI A50A	6081-1003	14433	IN4005		
R 101	RES FLM 100 K 5PCT 7W	6228-4105	14674	FP-5	100 K	5PCT
R 103	RES COMP 2.2 M 5PCT 1/2W	6100-5225	81349	RCR20G225J		
R 104	RES COMP 2.2 M 5PCT 1/2W	6100-5225	81349	RCR20G225J		
R 109	RES FLM 100 K 5PCT 7W	6228-4105	14674	FP-5	100 K	5PCT

NOTE: The number appearing on the foil side is not the part number.

ELECTRICAL PARTS LIST

RECTIFIER PC BOARD P/N 1864-2720

REFDES	DESCRIPTION	PART NO.	FMC	MFGR	PART NUMBER
C 101	CAP ALUM 10UF 475V	4450-6175	90201	TCG	10UF 475V
C 102	CAP ALUM 10UF 475V	4450-6175	90201	TCG	10UF 475V
C 103	CAP ALUM 10UF 475V	4450-6175	90201	TCG	10UF 475V
C 104	CAP ALUM 10UF 475V	4450-6175	90201	TCG	10UF 475V
C 105	CAP ALUM 10UF 475V	4450-6175	90201	TCG	10UF 475V
C 106	CAP ALUM 10UF 475V	4450-6175	90201	TCG	10UF 475V
C 112	CAP POLYPROPYLENE 4.7NF 10% 1.6KV	4863-4341	80183		715P472916LA3
CR 101	RECT IN4006 800PIV .5A SI A50A	6081-1004	14433		IN4006
CR 102	RECT IN4006 800PIV .5A SI A50A	6081-1004	14433		IN4006
CR 103	RECT IN4006 800PIV .5A SI A50A	6081-1004	14433		IN4006
CR 104	RECT IN4006 800PIV .5A SI A50A	6081-1004	14433		IN4006
R 101	RES FLM 100 K 5PCT 7W	6228-4105	14674		FP-5 100 K 5PCT
R 102	RES FLM 100 K 5PCT 7W	6228-4105	14674		FP-5 100 K 5PCT
R 103	RES COMP 470 K 5PCT 1/2W	6100-4475	81349		RCR20G474J
R 104	RES COMP 470 K 5PCT 1/2W	6100-4475	81349		RCR20G474J
R 105	RES COMP 470 K 5PCT 1/2W	6100-4475	81349		RCR20G474J
R 106	RES COMP 470 K 5PCT 1/2W	6100-4475	81349		RCR20G474J

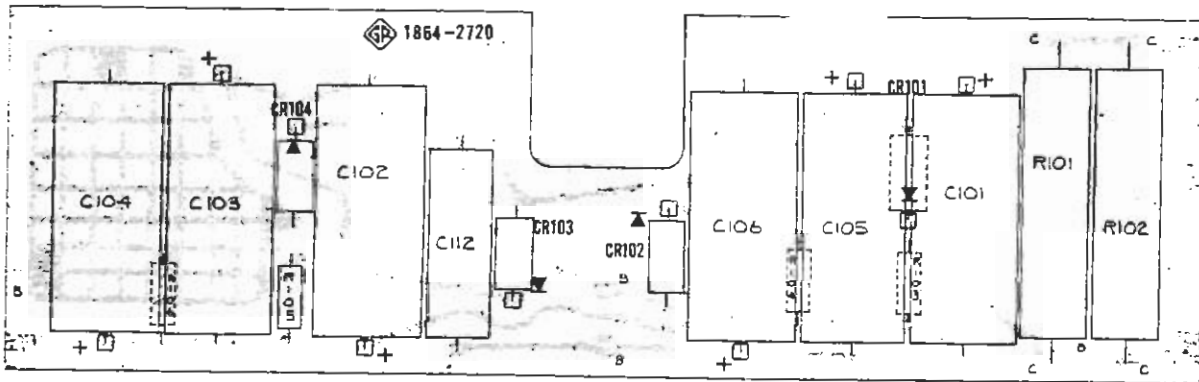

Figure 7-8. Type 1864 rectifier circuit etched-board assembly (P/N 1864-2720).

<u>Name</u>	<u>GR Part Number</u>
Cabinet Base	4182-1828
Cover	4182-8425
Handle	4182-8503
Handle Insert	4182-6020
Gasket, base (2 required)	5168-3620
Gasket, cover	5168-3605
Spacer Stop, Rubber	4182-7003
Foot, round (2 required)	5260-2051
Foot, square (4 required)	5260-2060
Side Plate Assembly	
Left	4182-1455
Right	4182-1475
Washer Nylon (2 required)	8030-1634
Pivot Shaft (2 required)	4182-6000
External Fastener Ring (2 required)	5210-0200
O Ring	5855-0156
Screw .0190-32 .500 Long	7080-1500
Washer .875 x .219 x .010	8120-0155

